

SHURJOINT®



Contents

Section 1
Grooved Mechanical Couplings, Flange Adapters & Mechanical Tees

Section 2
Cast & Wrought Grooved Fittings

Section 3
Stainless Steel Series

Section 4
Valves & Flow Control Components

Section 5
Threaded Fittings & Welding Outlets

Section 6
Ring Joint, Shouldered & Plain-End Couplings

Section 7
HDPE Series

Section 8
Copper Series

Section 9
AWWA Ductile Iron Series

Section 10
Technical Information

General Information

Foreword	3
Ductile Iron - Housing Material	4
Bolts and Nuts	5
Rubber Gasket Compounds	6
Data Chart Notes	8
Global Pipe Size Designations	9
Specifications, Standards, Codes and Organizations	10

General Notes

1. Always read and understand all **Shurjoint** installation instructions before installing any **Shurjoint** product.
2. Always depressurize and drain the piping system before attempting disassembly, adjustment or removal of any piping components.
3. Designers must know and understand all relevant building and or piping standards, codes and specifications. It is the responsibility of the designer to select and or specify the appropriate product for the intended use and service.
4. Always refer to the maximum pressure rating and service temperature range allowed for **Shurjoint** products and ensure that they are used within these parameters.
5. Special attention is required for selection of suitable gasket grades for the intended service application.
6. All information and data contained herein supersede all previous published data. **Shurjoint** reserves the right to change product designs and or specifications without notice and or obligation. Please refer to the **Shurjoint** web site for the latest information.

SHURJOINT

A World Leader in Mechanical Piping Components

Mechanical couplings were first developed in the 1920's and evolved into Grooved Mechanical Couplings during the 1950's & 60's. This revolution was further spurred in the latter half of the 20th century by advanced engineering and innovative materials such as Ductile Iron and EPDM elastomers.

Past to Present The history of **Shurjoint** dates back to 1974, when the founders produced their first grooved couplings. These first couplings were produced from malleable iron, the casting material of choice at this time. Before long foundry production was converted to ductile iron. Ductile iron was the ideal material, providing for precision castings and superior strength, without the need for further heat treatment. EPDM (ethylene propylene diene monomer) provided a great advancement in synthetic rubber elastomer compounds. This new compound offered a service life equal to or in some cases longer than that of carbon steel pipe. EPDM was an ideal gasket material for grooved piping systems.

A World Leader With over four decades of experience, **Shurjoint** is recognized as a world leader in the design and manufacture of mechanical piping components. **Shurjoint** has developed and currently offers over

3000 individual piping components in sizes from ½" to 104", for use with a variety of piping materials including carbon steel, stainless steel, ductile iron, PVC, HDPE, CPVC and copper tubing.

The Shurjoint Mission Our mission is to supply the highest quality products to customers worldwide with an unmatched level of customer service at a superior value. In addition to these hallmarks, **Shurjoint** continuously invests in research, engineering and development, resulting in innovative products and new solutions for the changing needs of industry.

The Shurjoint Catalog This catalog features our general product offering. For the latest and most complete listing of products, news and additional information please visit our website www.shurjoint.com or contact our Customer Service Representative. 

Typical Applications

HVAC	Reverse Osmosis
Fire Protection	Desalination
Water Supply & Treatment	Mining & Tunnel Boring
Plumbing	Marine
Municipal	Gas
Food Processing	Chemical
Pulp & Paper	Oil
Agriculture	Air



Taipei 101, 509.2M, the world tallest building 2004 - 2010

Ductile Iron – Housing Material

Ductile iron is an ideal material for grooved mechanical components, as it provides similar or greater strength to that of wrought or cast steel piping materials such as; forged steel flanges - ASTM A105, carbon steel valves - ASTM A216 WCB, wrought carbon steel pipe - ASTM A53 Gr. B, etc. Most **Shurjoint** components are made of ductile iron conforming to ASTM A536 Gr. 65-45-12 and or ASTM A395 Gr. 65-45-15.

Ductile iron was first invented in the U.S.A. and U.K. in the late 1940's. Superior strength was achieved by crystallizing graphite in the shape of nodules. The result was ductile iron that had tensile and yield strength properties that were equal to or greater than some steel castings. This superior strength combined with ductile iron's excellent castability helped to reduce the weight and cost of many components. Because of these advantages and benefits, many components have been converted from gray iron, malleable iron and steel castings to ductile iron over the past 60 years. Please visit the Ductile Iron Society website; www.ductile.org, for further information.

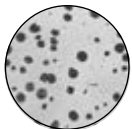

Ductile Iron
Superior tensile strength with good castability



Gray Iron
Excellent castability but 'brittle' – less strength

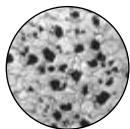

Malleable Iron
Stronger than gray iron but poor castability



Microstructure check

International ductile iron specifications equivalent to ASTM A536 Gr. 65-45-12 and or ASTM A395 Gr. 65-45-15 are;

SAE J434: D4512

EN1563: EN-GJS-450-10 or EN-GJS-450-15

JIS G5502: FCD450-10

SABS 936/937: SG42

Physical strength of materials comparative

	ASTM Designation	Tensile Strength, min. psi (MPa)	Yield Strength, min. psi (MPa)	Elongation in 2", %
Ductile iron castings	A536: Gr. 65-45-12	65,000 (448)	45,000 (310)	12
Ductile iron castings	A395: Gr. 65-45-15	65,000 (448)	45,000 (310)	15
Forged carbon steel	A105	70,000 (485)	40,000 (250)	20
Cast carbon steel	A216: WCB	70,000 (485)	36,000 (205)	22
Carbon steel pipe	A53: Gr. B	60,000 (415)	35,000 (240)	(29.5)
Malleable iron castings	A47: Gr. 32510	51,000 (345)	32,000 (224)	10
Gray iron castings	A126: Gr. B	31,000 (214)	Not specified	Not specified

ASTM A536, Grade 65-45-12 (UNS F33100)

Chemical Requirements*	Minimum	Maximum
Carbon, %	3.0	3.9
Silicon, %	2.5	3.0
Manganese, %	0.1	0.4
Phosphorus, %		0.07
Sulfur, %		0.02
Magnesium, %	0.03	0.05
Chromium, %		0.1
Physical Properties		
Tensile strength, psi (MPa)	65,000 (448)	---
Yield strength, psi (MPa)	45,000 (310)	---
Elongation, %	12	---

*Reference only as chemical requirements are not specified in ASTM A536.

ASTM A395, Grade 65-45-15 (UNS F33100)

Chemical Requirements	Minimum	Maximum
Carbon, %	3.0	
Silicon, %		2.5
Manganese, %	Not specified	
Phosphorus, %		0.08
Sulfur, %	Not specified	
Magnesium, %	Not specified	
Chromium, %	Not specified	
Physical Properties		
Tensile strength, psi (MPa)	65,000 (448)	---
Yield strength, psi (MPa)	45,000 (310)	---
Elongation, %	15	---

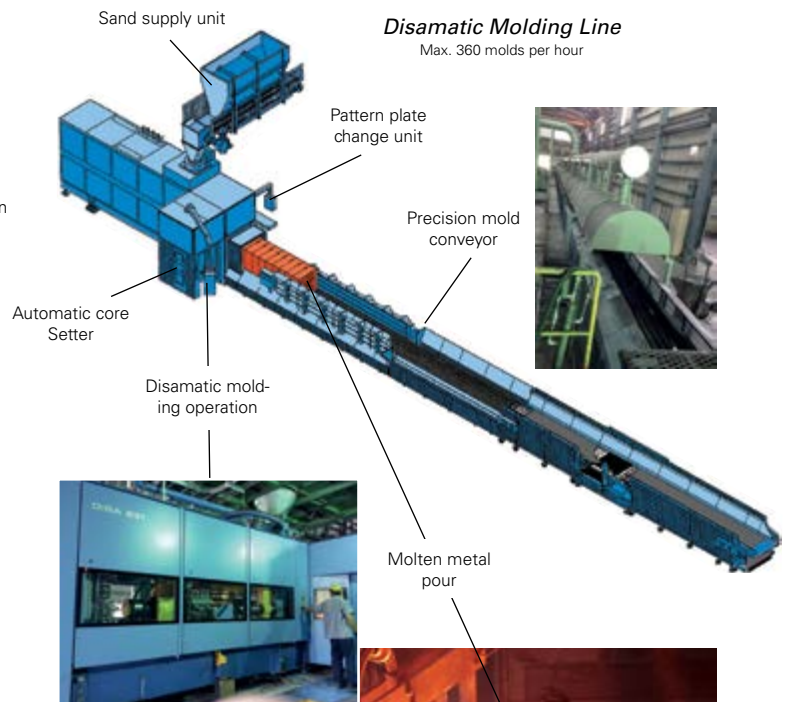

Bolts & Nuts

Carbon steel bolts and nuts

Shurjoint products utilize oval neck track bolts conforming to ASTM A449 or ASTM A183 Gr. 2 and heavy duty nuts to ASTM A563 Gr. B, available with UNC threads or ISO metric threads. The UNC track bolts and nuts are supplied electro zinc plated in a silver chromate color and ISO metric bolts and nuts in a gold chromate color. Hot-dip galvanized bolts and nuts are also available upon request.



A stainless steel bolt fastened with a silicon bronze nut

ASTM A449, Quenched and Tempered Steel Bolts*

Chemical Requirements	Minimum	Maximum
Carbon, %	0.28	0.55
Manganese, %	0.60	
Phosphorus, %		0.040
Sulfur, %		0.050
Physical Properties		
Tensile strength, psi (MPa)	120,000 (825)	-
Yield strength, psi (MPa)	92,000 (635)	-
Elongation, %	14	-

*Equivalent to property class 8.8 bolts per ISO 898.

ASTM A183, Grade 2 Carbon Steel Track Bolts

Chemical Requirements	Minimum	Maximum
Carbon, %	0.30	
Phosphorus, %		0.05
Sulfur, %		0.06
Physical Properties		
Tensile strength, psi (MPa)	110,000 (760)	--
Yield strength, psi (MPa)	80,000 (550)	--
Elongation, %	12	--

ASTM A563, Grade B Carbon and Alloy Steel Heavy Hex Nuts

Chemical Requirements (bolts)	Minimum	Maximum
Carbon, %		0.55
Phosphorus, %		0.12
Sulfur, %		0.15
Physical Properties		
Hardness, Rockwell	B69	C32

Stainless steel bolts and nuts

Stainless steel track bolts and nuts, type 304 or type 316, are supplied with Shurjoint stainless steel couplings. Track bolts and nuts are molybdenum disulfide (MoS₂) coated to inhibit galling. As an option, silicon bronze nuts are also available to further reduce the chance of galling.

ASTM A193, Grade B8 (Type 304) Stainless Steel Bolts

Chemical Requirements	Minimum	Maximum
Carbon, %		0.08
Manganese, %		2.00
Phosphorus, %		0.045
Sulfur, %		0.030
Silicon		1.00
Chromium, %	18.00	20.00
Nickel, %	8.00	10.50
Physical Properties		
Tensile strength, psi (MPa)	75,000 (515)	--
Yield strength, psi (MPa)	30,000 (205)	--
Elongation, %	30	--

ASTM A193, Grade B8M (Type 316) Stainless Steel Bolts

Chemical Requirements	Minimum	Maximum
Carbon, %		0.08
Manganese, %		2.00
Phosphorus, %		0.045
Sulfur, %		0.030
Silicon		1.00
Chromium, %	16.00	18.00
Nickel, %	10.00	14.00
Molybdenum	2.00	3.00
Physical Properties		
Tensile strength, psi (MPa)	75,000 (515)	-
Yield strength, psi (MPa)	30,000 (205)	-
Elongation, %	30	-

Silicon Bronze Nuts

ASTM B98 Alloy B Copper-Silicon Alloy (UNS No. C65100)

Chemical Requirements	Minimum	Maximum
Copper, %	96.0	
Lead, %		0.05
Iron, %		0.8
Zinc, %		1.5
Magnesium, %		0.7
Silicon, %	0.8	2.0
Physical Properties		
Tensile strength, psi (MPa)	55,000 (380)	
Yield strength, psi (MPa)	20,000 (140)	
Elongation, %	11	12

Recommended Bolt Torque Range

Always use factory supplied bolts and nuts for assembly of Shurjoint couplings. Shown below are the general recommended torque ranges for common sizes of carbon steel bolts. Never exceed the recommended torque range by more than 25% as excessive torque can lead to joint failure, personal injury and or property damage. Always depressurize and drain the piping system before attempting disassembly, adjustment or removal of any piping component. Follow installation instructions for proper assembly of all Shurjoint components. For questions contact Shurjoint.

Bolt Size		Proper Torque Range	
mm	in	Nm	Lbs-Ft
M10	3/8"	40-55	30-40
M12	1/2"	120-140	90-105
M16	5/8"	135-175	100-130
M20	3/4"	200-270	150-200
M22	7/8"	240-300	180-220
M24	1"	270-305	200-225
-	1 1/8"	-	225-275

For stainless steel bolts, reduce by 20%

Rubber Gasket Compounds

The 20th century was the era of innovation in plastic and rubber materials. Among the new synthetic rubber compounds that most impacted our industry were EPDM (ethylene propylene diene monomer) and Nitrile rubbers.

Please refer to the Gasket Selection Guide beginning on page 196 for additional information relating to service temperatures and chemical resistance.

EPDM is recognized as the most water resistant rubber available today. Good for cold & hot water up to 230°F (110°C), waste water, water with acid, deionized water and seawater. EPDM is not recommended for use with petroleum based oils and fuels, hydrocarbon solvents and aromatic hydrocarbons.



Green Stripe
Grade "E"



Violet Stripe
Grade "Lube-E"

Shurjoint Grade "E" EPDM is compounded per ASTM D2000 designation 2CA615A25B24F17Z. Peroxide curing and post curing give a higher crosslink density, which provides a higher aging resistance than required in AWWA C606.

	AWWA C606 2CA615A25B24F17Z	Shurjoint Standard
Basic Requirements		
Hardness, Durometer A, point	65±7	60±5
Tensile strength, psi, min.	1500 psi (10.34 MPa)	1500 psi (10.34 MPa)
Elongation, %, min.	300 %	300 %
Heat Aging Properties	After aged at 212°F (100°C) for 70 hours	After aged at 257°F (125°C) for 70 hours
Change in Durometer hardness, max.	+10 point	+5 points
Change in tensile strength, max.	-25%	-10%
Change in ultimate elongation, max.	-25%	-20%
Compression Set, Method B, max.	25%	20%

Use Shurjoint Grade "E-pw" for potable water and food processing services. The Grade "E-pw" is UL classified per NSF/ANSI 61 and NSF/ANSI 372 for cold +86°F (30°C) and hot +180°F (82°C) potable water services. EPDM seals are recommended for use in breweries as they have the least impact on the characteristics of beer or wort.



Double Green
Stripe

Note: EPDM materials used in domestic water applications with high levels of chlorine and/or chloramines should be subjected to resistance testing, as not all materials will be suitable. EPDM materials with higher saturated ethylene content and lower carbon black content are recommended for chloramine and chlorine resistance. Contact Shurjoint for further information.



Laboratory high temperature oven testing



Laboratory hot water testing

NBR, Buna-N, and Nitrile

all represent the same copolymer of butadiene and acrylonitrile (ACN), which is inherently resistant to hydraulic fluids, lubricating oils, transmission fluids and other non-polar petroleum based products and water less than 150° F (65° C). The higher the ACN content, the higher the resistance to oils and heat, but the lower elastic characteristics and compression set. NBR displays poor resistance to hot water and steam.



Orange Stripe

Shurjoint grade "T" NBR rubber is compounded based on ASTM D2000 designation 5BG615A14B24Z and exceeds the requirements of AWWA C606. Grade "T" is a general purpose compound with a medium ACN level. For fuels, especially those with a low aniline point, such as premium or unleaded gasoline, ASTM referenced fuels B & C and naphtha, use Shurjoint grade "M2" Epichloro-Hydrin or grade "O" Fluorocarbon.

	AWWA C606 5BG615A14B24Z	Shurjoint Standard
Basic Requirements		
Hardness, Durometer A, point	60±7	60±5
Tensile strength, psi, min.	1500 psi (10.34 MPa)	1500 psi (10.34 MPa)
Elongation, %, min.	300 %	300 %
When heat aged at 212°F (100°C) for 70 hours		
Change in Durometer hardness, max.	+10 point	±10 points
Change in tensile strength, max.	-25%	-20%
Change in ultimate elongation, max.	-30%	-30%
Compression Set, Method B, max.	25%	25%

Use Shurjoint Grade "A" white Nitrile gaskets for oily and greasy food products and processing, as well as pharmaceutical and cosmetics manufacturing. The Grade "A" is compounded from FDA approved ingredients (CFR Title 21 Part 177.2600).



White Gasket

Use Shurjoint Grade "S" Nitrile gaskets for joints with AWWA ductile iron pipe. Good for mineral oils, vegetable oils, air with oil vapors and water less than 150°F (65°C).



Red Stripe

Silicone (VMQ)

Shurjoint Grade "L" Silicone compound features high temperature range stability and low temperature flexibility. Recommended for dry heat and air without hydrocarbons up to 350°F (177°C). Silicone compounds are used in many food and medical applications as they do not impart odor or taste. Not recommended for hot water or steam services.



Red Gasket

Chloroprene (CR, Neoprene)

Shurjoint Grade "V" chloroprene rubber is a general purpose elastomer that demonstrates good resistance to lubricating oils, animal & vegetable fats and greases. Chloroprene is not effective in aromatic and oxygenated solvent environments and is not recommended for hot water and steam services.



Yellow Stripe

Fluorocarbon (FKM)

FKM is a highly fluorinated carbon backbone compound and offers excellent resistance to harsh chemical and ozone attack with a thermal stability to 300°F (149°C). Shurjoint Grade "O" fluorocarbon gasket is recommended for use with oils, gasoline, hydraulic fluids, hydrocarbon solvents and extended fuels that fall outside the service parameters of grade T / NBR compounds. Not recommended for steam services.



Blue Stripe

Epichloro-Hydrin (ECO)

Shurjoint Grade "M2" compound offers good to excellent resistance to aliphatic hydrocarbon and aromatic hydrocarbon fuels at low temperatures, LP gases & fuels, mineral oils and many solvents. ECO offers limited resistance to many organic chemicals.



White Stripe

Halogenated Butyl (CIIR)

Shurjoint Grade "M" CIIR is specially compounded for use with AWWA ductile iron pipe for water services, mild dilute acids, oil-free air and many chemicals. The compound is UL classified for potable water use per NSF/ANSI 61 and NSF/ANSI 372.



Brown Stripe

Data Chart Notes

Nominal Size	Pipe O.D.	Max. Working Pressure (CWP)	Max. End Load (CWP)	Axial Displacement	Angular Movement		Dimensions			Bolt Size	Bolt Torque	Weight
					Degree Per Coupling	Pipe	A	B	C			
in	in	PSI	Lbs	in	(°)	ft / in	in	in	in	in	Lbs-Ft	Lbs
mm	mm	Bar	kN	in / mm		mm / m	mm	mm	mm		Nm	Kgs

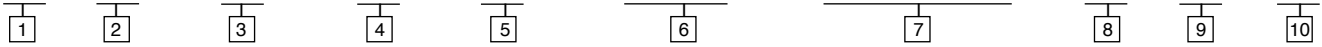

- Nominal Size:** Shurjoint couplings and fittings are identified by the nominal IPS pipe size in inches or nominal diameter of pipe (DN) in millimeters. Refer to the chart on the next page which shows a comparison between typical metric and IPS pipe sizes
- Pipe O.D.:** Actual outside diameter of pipe in inches and millimeters.
- Maximum Working Pressure (CWP):** Maximum working pressures listed are CWP (cold water pressure) or maximum allowed working pressure within the service temperature range of the gasket used in the coupling, based on standard wall or sch. 40 steel pipe, cut or roll-grooved to ANSI/AWWA C606 (latest edition) specifications and tested to ASTM F1476. Burst test pressures are minimum 3 times the maximum working pressures unless otherwise specified.
These ratings may occasionally differ from maximum working pressures listed and/or approved by UL, ULC, and/or FM as testing conditions and test pipes differ. For performance data on other pipe schedules contact **Shurjoint**.
- Maximum End Load:** Maximum end loads listed are total of internal and external forces to which the joint can be subjected, based on standard wall or sch. 40 steel pipe, cut or roll-grooved to ANSI/AWWA C606 (latest edition) specifications.
- Axial Displacement:** Designed range of the gap between pipe ends based on roll grooved pipe.
- Angular Movement (Deflection):** Allowable Axial Displacement and Angular Movement (deflection) figures are for roll grooved standard steel pipe. Values for cut grooved pipe will be double that of roll grooved. These values are maximums; for design and installation purposes these figures should be reduced by: 50% for ¾"/DN20 – 3½"/DN90; 25% for 4"/DN100 and larger to compensate for jobsite conditions.

Maximum allowable deflection of pipe from centerline when the joint is used with cut or roll-grooved steel pipe under no internal pressure.
- Dimensions:** "A", "B", "C" and so on are external dimensions for reference purpose only in inches and millimeters.
- Bolt Size:** UNC bolt size and length in inches and ISO metric bolt size and length in millimeters with numbers of bolts where applicable.
- Bolt Torque:** Recommended bolt fastening torque in Nm and Lbs-Ft.
- Weight:** Weight of a coupling complete with gasket, bolts and nuts or of a fitting in kilograms and pounds.

Nominal Size / Pipe O.D.

While **Shurjoint** fittings are normally identified by the nominal size, always check the actual O.D. of the pipe and fittings to be connected, as in some markets it is customary to refer to different O.D. pipes with the same nominal size.

For example: The nominal size 65 (2½") is referred to 73.0 mm (2.875") pipe O.D. in IPS and 76.1 mm (3.000") pipe O.D. in BS, ISO or JIS pipes. Refer to pipe & tubing standards for details.

Pipe & Tubing Standards

(ANSI) American National Standards Institute B36.10 & B36.19

(API) American Petroleum Institute API 5L

(ASTM) American Society of Testing and Materials A135, A795 & B88

(BS) British Standards BS1387, BS3600, BS3601 & BS3605

(ISO) International Standard Organization 65 & 4200

(JIS) Japan Industrial Standard G3452 & G3459

Global Pipe Size Designations

Shurjoint product data & technical data are identified by the nominal IPS pipe size in inches or nominal diameter of pipe (DN) in millimeters.

The following chart shows a comparison between typical IPS size and metric (DIN) sizes.

Nominal Size		Outside Diameter (O.D.)								
Inches (Imperial)	DN (Metric,mm)	mm (Actual Pipe O.D.)	DIN mm	BS mm	ISO mm	JIS mm	ANSI in	GB mm	India	
									IS 1239	IS 3589
½	15	21.3 mm	DN 15	DN 15	DN 15	21.7 mm	½	DN 15	DN 15	-
¾	20	26.7 mm	26.9 mm	DN 20	DN 20	27.2 mm	¾	DN 20	DN 20	-
1	25	33.4 mm	33.7 mm	DN 25	DN 25	34.0 mm	1	DN 25	DN 25	-
1¼	32	42.2 mm	42.4 mm	DN 32	DN 32	42.7 mm	1¼	DN 32	DN 32	-
1½	40	48.3 mm	DN 40	DN 40	DN 40	48.6 mm	1½	DN 40	DN 40	-
2	50	60.3 mm	DN 50	DN 50	DN 50	60.5 mm	2	DN 50	DN 50	-
2½	65	73.1 mm	-	-	-	-	2½	-	-	-
		76.1 mm BS/ISO	76.1 mm	76.1 mm	76.1 mm	76.3 mm	-	76.1 mm**	76.1 mm	-
3	80	88.9 mm	DN 80	DN 80	DN 80	DN 80	3	DN 80	DN 80	-
3½	90	101.6 mm	-	-	-	-	-	-	-	-
4	100	108.0 mm China (& old DIN)	DIN 133.0 mm	-	-	-	-	108.0 mm**	-	-
		114.3 mm	DN 100	DN 100	DN 101	DN 100	4	DN 100	DN 100	-
-	127.0 mm	127.0 mm	-	-	-	-	-	-	-	-
5	125	133.0 mm China	-	-	-	-	-	133.0 mm**	-	-
		139.7 mm BS/ISO	DN 125	139.7 mm	139.7 mm	139.8 mm	-	139.7 mm	139.7 mm	-
		141.3 mm	-	-	-	-	5	-	-	-
-	152.4 mm	152.4 mm	-	-	-	-	-	-	-	-
6	150	159.0 mm China	-	-	-	-	-	159.0 mm	-	-
		165.1 mm JIS/BS	-	165.1 mm	-	165.2 mm	-	-	165.1 mm	-
		168.3 mm	DN 150	-	DN 150	-	6	DN 150	-	DN 150
-	6	193.7 mm	-	-	-	-	-	-	-	193.7 mm
-	203.2 mm	203.2 mm	-	-	-	-	-	-	-	-
8	200	216.3 mm JIS	-	-	-	216.3 mm	-	-	-	-
		219.1 mm	DN 200	DN 200	DN 200	-	8	DN 200	DN 200	DN 200
		254.0 mm	-	-	-	-	-	-	-	-
10	250	267.4 mm JIS	-	-	-	267.4 mm	-	-	-	-
		273.0 mm	DN 250	DN 250	DN 250	-	10	DN 250	DN 250	DN 250
		304.8 mm	-	-	-	-	-	-	-	-
12	300	318.5 mm JIS	-	-	-	318.5 mm	-	-	-	-
		323.9 mm	DN 300	DN 300	DN 300	-	12	-	-	-
		355.6 mm	DN 350	DN 350	DN 350	DN 350	14	DN 350	-	-
14	350	377.0 mm China	-	-	-	-	-	377.0 mm	-	-
		406.4 mm	DN 400	DN 400	DN 400	DN 400	16	DN 400	-	-
16	400	426.0 mm China	-	-	-	-	-	426.0 mm	-	-
		457.2 mm	DN 450	DN 450	DN 450	DN 450	18	DN 450	-	-
18	450	480.0 mm China	-	-	-	-	-	480.0 mm	-	-
		508.0 mm	DN 500	DN 500	DN 500	DN 500	20	DN 500	-	-
20	500	530.0 mm China	-	-	-	-	-	530.0 mm	-	-
		558.8 mm	-	-	-	DN 550	22	559.0 mm	-	-
		580.0 mm China	-	-	-	-	-	580.0 mm	-	-
22	550	610.0 mm	DN 600	DN 600	DN 600	DN 600	24	DN 600	-	-
		630.0 mm China	-	-	-	-	-	630.0 mm	-	-

Important Note:

Nominal designations are used where the actual O.D. of the pipe matches the ANSI size.

Otherwise both the nominal and actual O.D. are listed.

China sizes are listed as actual O.D. in mm.

** China sizes are tubing sizes.

Specifications, Standards, Codes and Organizations

Shurjoint production facilities are certified to ISO 9001. Products are designed to conform and meet or exceed all applicable domestic and international standards and are listed, approved and or certified by

various approval bodies and registration authorities. Shurjoint is also active in industry and environmental organizations.



ANSI
American National Standards Institute



ANSI/AWWA
American Water Works Association C606
(latest edition)

ASME
American Society of Mechanical Engineers
Power Piping, B31.1
Building Services Piping, B31.9



ASTM
American Society of Testing and Materials
F 1476-01 Couplings
F 1548-01 Fittings
F 1155 Shipbuilding



CNBOP-PIB
Scientific and Research Centre for Fire
Protection - National Research Institute



CSA
Canadian Standards Association B-242



DLEG
State of Michigan Board of Mechanical Rules



FM
Factory Mutual Research Corp. - Approved for
Fire Protection Services



FESC
Japan Fire Equipment Safety Center



IAPMO R&T
IAPMO Research and Testing, Inc.



LLOYD
Lloyd's Register Quality Assurance
ISO 9001:2008



LPCB
Loss Prevention Certification Board
LPS-1219



NFPA
National Fire Protection Association NFPA 13



NSF
NSF/ANSI 61 Drinking Water System
Components - Health Effects
NSF/ANSI 372 Drinking Water System
Components - Lead Content



NYC MEA
New York City Department of Buildings,
Material & Equipment Acceptance



NYPA
New York Power Authority



PED
Pressure Equipment Directory 2014/68/EU



UL
Underwriter's Laboratories, Inc. - UL213



ULC
Underwriter's Laboratories of Canada



TSUS
Technický a Skúšobný Ústav Stavebný, n. o.



VdS
VdS Schadenverhütung

Section 1

Grooved Mechanical Couplings, Flange Adapters & Mechanical Tees

Grooved Mechanical Couplings	14
Rigid & Flexible Couplings	15
M07 Quick Install Coupling	16
Z05 Rigid Coupling	17
K-9 Rigid Coupling	18
Z07 Heavy Duty Rigid Coupling	19
Z07N Heavy Duty Rigid Coupling	20
7771 Standard Rigid Coupling	21
XH-1000 Extra Heavy Rigid Coupling	22
7705 Flexible Coupling	23
7707 Heavy Duty Flexible Coupling.....	24
7707N Flexible Coupling, 14" ~ 26"	25
7707L Large Diameter Coupling.....	26
7706 Reducing Coupling	27
G28 Hinged Lever Coupling	28
C-7 Outlet Coupling	29
7706-T & 7771-T Transition Couplings	30
XH-70EP Extra Heavy Rigid Coupling w/EP Gasket	31
Flange Adapters	32
7041 Flange Adapter, ANSI Class 125/150	33
7041 Flange Adapter, PN10/16	34
7041 Flange Adapter, BS 10 Table E.....	35
7043 Flange Adapter ANSI Class 300	35
49 Sandwich Plate.....	33
7170 Flange Adapter ANSI Class 125/150	36
7180 & 7181 Universal Flange Adapters	37
Mechanical Tees	38
7721 Mechanical Tee, Female Threaded Outlet	39
M21 Mechanical Tee, Female Threaded Outlet.....	41
7722 Mechanical Tee, Grooved-End Outlet	43
M22 Mechanical Tee, Grooved-End Outlet.....	45
723 Saddle-Let	47
Pressure Performance Data	48

Shurjoint Grooved Mechanical Couplings

The **Shurjoint** grooved piping system is one of the most advanced, versatile, economical and reliable systems available today. After the pipe ends are grooved a gasket is mounted over the pipe ends. The coupling segments are then placed over the gasket and the bolts and nuts are fastened resulting in a secure and leak free joint.

A coupling can be installed 3 – 4 times faster than a comparable welded or brazed joint and there is no need for a flame or welding torch on the job site. A grooved mechanical coupling can be installed by fastening a pair of bolts and nuts while using only a wrench or spanner, whereas a comparable flanged joint requires the fastening of many bolts and nuts with a pair of wrenches. The grooved system allows for easy material take-offs and unlike a threaded system, there is no need to allow for added pipe length for thread engagement. With removal of just a few bolts one can easily access the system for cleaning, maintenance, changes and or system expansion.



Helpful Information to Ensure Proper Assembly

Some couplings and components require the housing bolt pads to make metal-to-metal contact for proper assembly, while others require a specific bolt torque while maintaining equal bolt pad gaps. The icons and information below will help to identify those items to ensure proper assembly. Read and follow all installation instructions for the component being installed.



Metal-to-metal contact: Tighten bolts and nuts until bolt pads make metal-to-metal contact. After metal-to-metal contact is achieved, tighten nuts by another one quarter or one half turn to make sure the bolts and nuts are snug and secure. No torque wrench is required. Excessive torque may lead to bolt or joint failure.

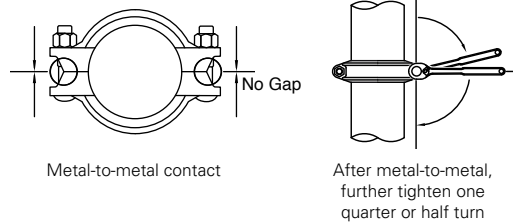

Torque required! Bolts and nuts must always be tightened to the required torque by using a torque wrench. Normally there will be some gaps seen between the bolt pads after the bolts and nuts are fully tightened. Bolt pad gaps should be equal on both sides of the coupling. Models that require torque tightening include 2" through 4" of model XH-1000, all sizes of models XH-70EP, SS-7X and 79 couplings.

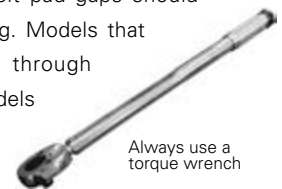

#SS-7X 10" ~ 24"



#79 2" ~ 20"

Rigid & Flexible Couplings

Grooved mechanical couplings (GMC) are available in both rigid and flexible models. A rigid coupling is used in applications where a rigid joint is desired, similar to that of a traditional flanged, welded, and or threaded connection. To be considered rigid, a coupling would allow less than one degree of deflection or angular movement.

Flexible couplings are designed to accommodate axial displacement, rotation and a minimum one degree of angular movement. Flexible couplings are used in applications that call for curved or deflected layouts and or when systems are exposed to outside forces beyond normal static conditions, such as seismic events or where vibration and or noise attenuation are a concern.

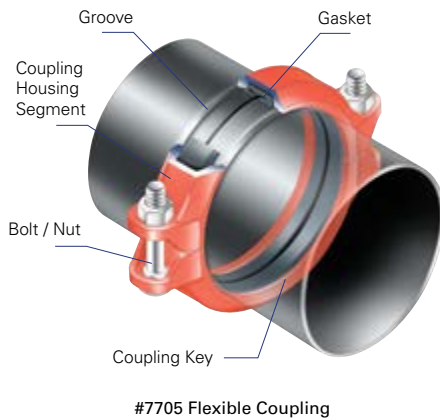

Grooved couplings become less flexible as the pipe size increases. For sizes in excess of 18" (450 mm) couplings are very limited in their angular movement. Please refer to the following definition and test methods.

Definition Grooved couplings are subjected to internal pressures and exterior bending forces during service. ASTM F1476-07 defines a rigid coupling as a joint where there is essentially no available free angular or axial pipe movement and a flexible coupling as a joint wherein there is available limited angular and axial pipe movement.

Bending Moment Test bending moments are calculated by the equation $M = F(L)$, where F is weight of water filled pipe (Lbs) and L is hanger spacing x 1/2 (feet). The table below shows test bending moments calculated using sch. 40 pipe with NFPA 13 hanger spacing.

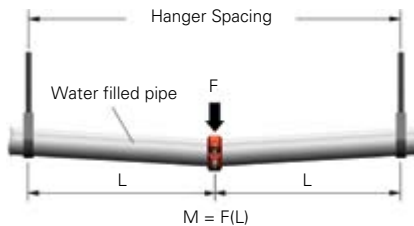

Test Bending Moment (ASTM F1476)

Nom. Size (inches)	Moment Nm	Moment Lbs-Ft
1½	549	405
2	780	575
2½	1200	885
3	1645	1213
4	2471	1823
5	3551	2619
6	4803	3543
8	7663	5652
10	11379	8393
12	15558	11475
14	18609	13725
16	24299	17922

Flexibility Proof Test Flexibility proof testing is conducted by applying a small bending moment, 10% of the listed moment, to the test assembly with no internal pressure. A 4" model 7705 or 7707 flexible coupling deflects 3 – 4 degrees depending on the type of groove processed.

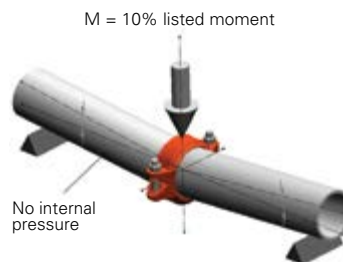

Rigidity Proof Test Rigidity proof testing is conducted by applying 25% of the listed moment to the test assembly which is internally pressurized to the rated pressure.

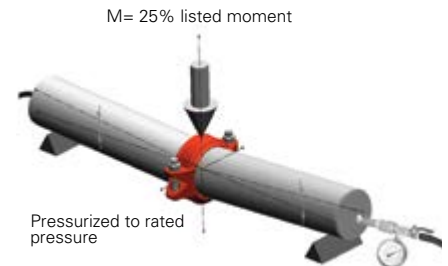

The rigid coupling shall pass the test when the angle has not changed more than angle θ . θ shall be calculated as follows: $\theta^\circ = 60' (\text{minutes}) - [2' (\text{minutes}) \times (\text{nominal pipe size in inches})]$. In other words, when θ is less than 1 degree (60 minutes), the grooved mechanical coupling is verified as a rigid coupling and when θ is more than 1 degree (60 minutes), the GMC is regarded as a flexible coupling. The maximum angles θ for rigid couplings are shown in the table below:

Rigid Coupling - Max. Deflection

Nom. Size (inches)	θ , max (minutes)	θ , max. (degrees)
1½	57	0.95
2	56	0.93
2½	55	0.92
3	54	0.90
4	52	0.87
5	50	0.83
6	48	0.80
8	44	0.73
10	40	0.67
12	36	0.60
14	32	0.53
16	28	0.47

Bending Moment Proof Test The coupling shall resist a 100% listed bending moment while the assembly is internally pressurized to the rated pressure.

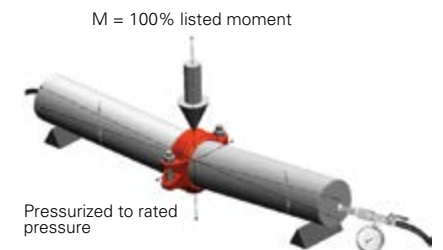

M07 Quick Install Coupling

The **Shurjoint** Model M07 is a ready to install rigid coupling for general piping applications where rigidity is required including valve connections, mechanical rooms, risers and long straight runs. This proprietary design provides a rigid joint that resists flexural and torsional loads. Support and hanging requirements corresponding to ANSI B31.1, B31.9 and NFPA 13.

The **Shurjoint** Model M07 is available with a proprietary EPDM gasket, which includes a GapSeal and a center leg feature

to support the coupling during installation. The M07 includes two identical housing segments and a fully constrained wedge. Proper installation requires the tightening of only one bolt/nut. As this bolt/nut is tightened, the wedge applies uniform compression to the gasket, reducing the chance of pinching. The hinge bolt/nut is factory pre-set and requires no adjustment.

Patent Pending



Caution: Ensure coupling bolt pads make metal-to-metal contact. Wedge allowed 1/16" gap top and bottom.

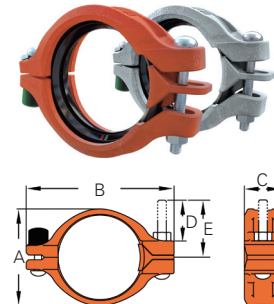

Nominal Size Run x Branch	Pipe O.D.	Max. Working Pressure (CWP)**	Max. End Load (CWP)	Dimensions					Bolt Size	Weight
				A	B	C	D	E		
in	in	PSI	lb	in	in	in	in	in	in	Lbs
mm	mm	Bar	kN	mm	mm	mm	mm	mm	mm	Kgs
2	2.375	750	3320	3.36	5.58	1.90	2.39	3.26	½ x 3.8	2.9
50	60.3	52	14.84	85	142	48	61	83	M12 x 97	1.3
2-½	2.875	750	4860	3.80	6.29	1.90	2.39	3.26	½ x 3.8	3.3
65	73.0	52	21.75	97	160	48	61	83	M12 x 97	1.5
76.1	3.000	750	5310	3.88	6.42	2.01	2.07	2.88	½ x 3.8	3.30
	76.1	52	23.64	99	163	51	53	73	M12 x 97	1.5
3	3.500	750	7210	4.42	7.10	1.90	2.39	3.26	½ x 3.8	3.8
80	88.9	52	32.26	112	180	48	61	83	M12 x 97	1.7
4	4.500	750	11920	5.44	8.35	2.11	2.29	3.21	½ x 3.8	5.1
100	114.3	52	53.33	138	212	54	58	82	M12 x 97	2.3
139.7	5.500	750	17900	6.73	9.84	2.13	2.17	3.09	⅝ x 4.0	7.71
	139.7	52	79.66	171	250	54	55	79	M16 x 102	3.5
5	5.563	750	17900	6.73	9.84	2.13	2.17	3.09	⅝ x 4.0	7.71
125	141.3	52	79.66	171	250	54	55	79	M16 x 102	3.5
6	6.625	700	24110	7.77	10.90	2.11	2.56	3.49	⅝ x 4.0	8.4
150	168.3	48	106.73	197	277	54	65	89	M16 x 102	3.8
8	8.625	600	35580	10.74	13.79	2.52	2.46	3.43	⅝ x 4.0	17.40
200	219.1	42	158.27	273	350	64	62	87	M16 x 102	7.9

Performance Data

The following table show the maximum working pressures (CWP) of **Shurjoint** Model M07 Coupling used on carbon steel and stainless steel.

General Notes

- Maximum Working Pressure (CWP) listed is the maximum cold water pressure for general piping services tested to ASTM F1476 and or AWWA C606 methods. Figures listed are based on roll- or cut-grooved standard wall carbon steel pipe. For other pipe schedules or pipe materials, contact **Shurjoint** for additional information.
- Max. End Load is calculated based on the maximum working pressure (CWP).
- Field Joint Test: For one time only the system may be tested hydrostatically at 1.5 times the maximum working pressure listed (AWWA C606 5.2.3).

Carbon Steel Pipe

Nominal Size	Cut-Grooved		Roll-Grooved	
	XS	STD	STD	Sch 10
in	psi	psi	psi	psi
mm	Bar	Bar	Bar	Bar
2	750	750	750	750
50	52	52	52	52
2½	750	750	750	600
65	52	52	52	42
3	750	750	750	600
80	52	52	52	42
4	750	750	750	600
100	52	52	52	42
5	750	750	750	500
125	52	52	52	35
6	500	500	600	300
150	35	35	42	21
8	600	600	600	300
200	42	42	42	21

- Warning: Piping systems must always be depressurized and drained before attempting disassembly and or removal of any components.
- The 10 Year Limited Warranty applies to manufacturing defects only and does

Stainless Steel Pipe

Nominal Size	Cut-Grooved		Roll-Grooved	
	XS	STD	Sch 40S	Sch 10S
in	psi	psi	psi	psi
mm	Bar	Bar	Bar	Bar
2	600	600	600	300
50	42	42	42	21
2½	600	600	600	300
65	42	42	42	21
3	600	600	600	300
80	42	42	42	21
4	600	600	600	300
100	42	42	42	21
5	600	600	600	300
125	42	42	42	21
6	500	500	600	300
150	35	35	42	21
8	400	400	400	150
200	28	28	28	10

- not cover severe service/temperature applications or wear parts.
- **Shurjoint** reserves the right to change specifications, designs and or standard without notice and without incurring any obligations.

Model Z05 Rigid Coupling - Angle-Pad Design

The Shurjoint Model Z05 is an angle-pad design rigid coupling for moderate pressure piping services including fire mains, long straight runs and valve connections. The angle-pad design allows the coupling housings to slide along the bolt pads when tightened. The result is an offset clamping action which provides a rigid joint which

resists so-called 'snaking' of a long straight run. Support and hanging requirements correspond to ANSI B31.1, B31.9 and NFPA 13.

With the removal of only one bolt you can make a fast and easy 'swing-over' installation.



The angle pad design allows for fast and easy swing-over installation with the removal of a single bolt.

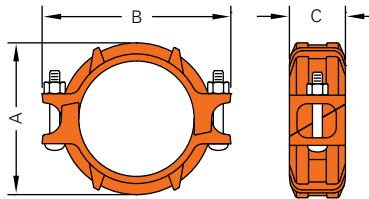
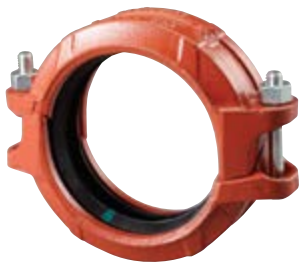

Nominal Size	Pipe O.D.	Max. Working Pressure (CWP)*	Max. End Load (CWP)	Axial Displacement †	Dimensions			Bolt		Weight
					A	B	C	No.	Size	
in	in	PSI	Lbs	in	in	in	in	in	Lbs	
mm	mm	Bar	kN	mm	mm	mm	mm	mm	Kgs	
1¼	1.660	500	1080	0 ~ 0.05	2.60	4.00	1.81	2	¾ x 2½	1.41
32	42.2	35	4.89	0 ~ 1.2	66	102	46		M10 x 55	0.64
1½	1.900	500	1410	0 ~ 0.05	2.83	4.29	1.81	2	¾ x 2½	1.46
40	48.3	35	6.41	0 ~ 1.2	72	109	46		M10 x 55	0.66
2	2.375	500	2210	0 ~ 0.07	3.35	4.61	1.85	2	¾ x 2¾	1.74
50	60.3	35	9.99	0 ~ 1.7	85	117	47		M10 x 70	0.79
2½	2.875	500	3240	0 ~ 0.07	3.86	5.24	1.85	2	¾ x 2¾	2.05
65	73.0	35	14.64	0 ~ 1.7	98	133	47		M10 x 70	0.93
76.1 mm	3.000	500	3530	0 ~ 0.07	3.94	5.35	1.85	2	¾ x 2¾	2.16
	76.1	35	15.91	0 ~ 1.7	100	136	47		M10 x 70	0.98
3	3.500	500	4800	0 ~ 0.07	4.45	5.91	1.88	2	¾ x 2¾	2.60
	80	88.9	35	21.71	0 ~ 1.7	113	150		48	M10 x 70
108.0 mm	4.250	500	7080	0 ~ 0.16	5.59	6.93	2.13	2	¾ x 2¾	3.62
	108.0	35	32.05	0 ~ 4.1	142	176	54		M10 x 70	1.64
4	4.500	500	7940	0 ~ 0.16	5.75	7.20	2.13	2	¾ x 2¾	4.12
	100	114.3	35	35.89	0 ~ 4.1	146	183		54	M10 x 70
133.0 mm	5.250	350	7570	0 ~ 0.16	6.69	8.82	2.13	2	½ x 3	5.14
	133.0	24	33.33	0 ~ 4.1	170	224	54		M12 x 75	2.33
139.7 mm	5.500	350	8310	0 ~ 0.16	6.81	8.98	2.09	2	½ x 3	5.67
	139.7	24	36.77	0 ~ 4.1	173	228	53		M12 x 75	2.57
5	5.563	350	8500	0 ~ 0.16	6.89	9.06	2.13	2	½ x 3	5.69
	125	141.3	24	37.62	0 ~ 4.1	175	230		54	M12 x 75
159.0 mm	6.250	350	10730	0 ~ 0.16	7.80	9.84	2.09	2	½ x 3	6.06
	159.0	24	47.63	0 ~ 4.1	198	250	53		M12 x 75	2.75
165.1 mm	6.500	350	11600	0 ~ 0.16	7.87	9.92	2.09	2	½ x 3	6.72
	165.1	24	51.35	0 ~ 4.1	200	252	53		M12 x 75	3.05
6	6.625	350	12050	0 ~ 0.16	8.00	10.0	2.09	2	½ x 3	6.77
	150	168.3	24	53.36	0 ~ 4.1	203	254		53	M12 x 75
8	8.625	350	20430	0 ~ 0.19	10.40	12.68	2.52	2	¾ x 5½/16	13.38
	200	219.1	24	90.44	0 ~ 4.8	264	322		64	M16 x 135
200 JIS	8.516	350	19920	0 ~ 0.19	10.24	13.35	2.50	2	¾ x 4¾	15.43
	216.3	24	88.14	0 ~ 4.8	260	339	64		M20 x 120	7.00

* Working Pressure is based on roll grooved standard wall carbon steel pipe.

† Allowable Axial Displacement and Angular Movement (deflection) figures are for roll grooved standard steel pipe. Values for cut grooved pipe will be double that of roll grooved. These values are maximums; for design and installation purposes these figures should be reduced by: 50% for ¾/DN20 - 3½/DN90; 25% for 4/DN100 and larger to compensate for jobsite conditions.

Model K-9 Rigid Coupling

- T & G Design

The Shurjoint Model K-9 is a T&G (tongue & groove) design rigid coupling for moderate pressure applications where rigidity is required including valve connections, mechanical rooms, fire mains and long

straight runs. The built-in teeth and T&G mechanism firmly grasp the pipe ends to eliminate undesired flex. Support and hanging requirements correspond to ANSI B31.1, B31.9 and NFPA 13.

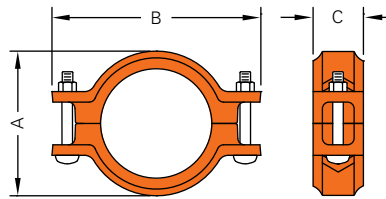
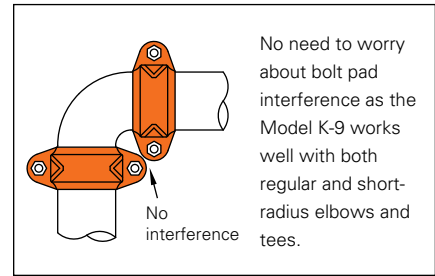

Nominal Size	Pipe O.D.	Max. Working Pressure (CWP)**	Max. End Load (CWP)	Axial Displacement	Dimensions			Bolt Size	Weight
					A	B	C		
in	in	PSI	Lbs	in	in	in	in	in	Lbs
mm	mm	Bar	kN	mm	mm	mm	mm	mm	Kgs
1¼	1.660	500	1080	0~0.06	2.56	4.33	1.73	¾ x 1¾	1.3
32	42.2	35	4.82	0~1.6	65	110	44	M10 x 45	0.6
1½	1.900	500	1410	0~0.06	2.80	4.45	1.73	¾ x 2½	1.3
40	48.3	35	6.32	0~1.6	71	113	44	M10 x 55	0.6
2	2.375	500	2210	0~0.06	3.27	4.88	1.73	¾ x 2½	1.5
50	60.3	35	9.85	0~1.6	83	124	44	M10 x 55	0.7
2½	2.875	500	3240	0~0.06	3.86	5.39	1.73	¾ x 2½	1.8
65	73.0	35	14.43	0~1.6	98	137	44	M10 x 55	0.8
76.1 mm	3.000	500	3530	0~0.06	4.00	5.51	1.73	¾ x 2½	1.8
	76.1	35	15.68	0~1.6	102	140	44	M10 x 55	0.8
3	3.500	500	4800	0~0.06	4.50	5.94	1.73	¾ x 2¾	2.6
80	88.9	35	21.40	0~1.6	114	151	44	M10 x 70	1.2
4	4.500	350	5560	0~0.13	5.63	7.48	1.97	¾ x 2¾	3.6
100	114.3	24	24.72	0~3.2	143	190	50	M10 x 70	1.7
139.7 mm	5.500	350	8310	0~0.13	6.77	9.21	2.00	½ x 3	4.6
	139.7	24	36.92	0~3.2	172	234	51	M12 x 75	2.1
5	5.563	350	8500	0~0.13	6.89	8.98	1.97	½ x 3	4.6
125	141.3	24	37.77	0~3.2	175	228	50	M12 x 75	2.1
165.1 mm	6.500	350	11600	0~0.13	7.75	9.92	2.09	½ x 3	5.3
	165.1	24	51.57	0~3.2	197	252	53	M12 x 75	2.4
6	6.625	350	12050	0~0.13	7.87	10.04	2.09	½ x 3	5.9
150	168.3	24	53.59	0~3.2	200	255	53	M12 x 75	2.7
8	8.625	350	20430	0~0.13	10.16	13.15	2.44	¾ x 3½	9.7
200	219.1	24	90.82	0~3.2	258	334	62	M16 x 90	4.4
8 (K-9H)	8.625	350	20430	0~0.13	10.29	13.08	2.44	¾ x 4¾	15.8
	200	219.1	24	90.82	0~3.2	261	332	62	M20 x 120

All DIN size K-9 couplings up to DN150 size and the DN200 K-9H coupling are VdS approved in addition to cULus and FM approvals.

** Working Pressure is based on roll grooved standard wall carbon steel pipe.

Model Z07 Heavy Duty Rigid Coupling

The Shurjoint Model Z07 is an angle-pad design rigid coupling for general piping applications where rigidity is required including, mechanical rooms, valve connections fire mains and long straight runs. The angle-pad design allows the coupling

housings to slide along the bolt pads when tightened. The result is an offset clamping action which provides a rigid joint that resists flexural and torsional loads. Support and hanging requirements correspond to ANSI B31.1, B31.9 and NFPA 13.

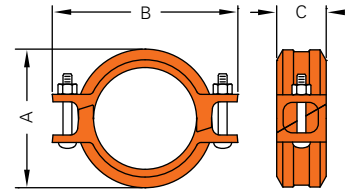

Nominal Size	Pipe O.D.	Max. Working Pressure (CWP)*	Max. End Load (CWP)	Axial Displacement †	Dimensions			Bolt		Weight
					A	B	C	No.	Size	
in	in	PSI	Lbs	in	in	in	in	No.	in	Lbs
mm	mm	Bar	kN	mm	mm	mm	mm		mm	Kgs
1¼	1.660	750	1620	0 ~ 0.05	2.68	4.13	1.85	2	¾ x 2½	1.6
32	42.2	52	7.27	0~1.2	68	105	47	2	M10 x 55	0.7
1½	1.900	750	2120	0 ~ 0.05	2.91	4.53	1.85	2	¾ x 2½	2.0
40	48.3	52	9.52	0~1.2	74	115	47	2	M10 x 55	0.9
2	2.375	750	3320	0 ~ 0.07	3.39	4.69	1.88	2	¾ x 2¾	2.4
50	60.3	52	14.84	0~1.7	86	119	48	2	M10 x 70	1.1
2½	2.875	750	4860	0 ~ 0.07	3.94	5.50	1.88	2	¾ x 2¾	2.4
65	73.0	52	21.75	0~1.7	100	140	48	2	M10 x 70	1.1
76.1 mm	3.000	750	5290	0 ~ 0.07	4.00	5.75	1.88	2	¾ x 2¾	2.4
	76.1	52	23.64	0~1.7	102	146	48		M10 x 70	1.1
3	3.500	750	7210	0 ~ 0.07	4.53	6.54	1.88	2	½ x 3	3.1
80	88.9	52	32.26	0~1.7	115	166	48	2	M12 x 75	1.4
4	4.500	750	11920	0 ~ 0.16	5.78	8.11	2.13	2	½ x 3	4.4
100	114.3	52	53.33	0~4.1	147	206	54	2	M12 x 75	2.0
139.7 mm	5.500	750	17810	0 ~ 0.16	6.88	9.37	2.09	2	¾ x 3½	6.6
	139.7	52	79.66	0~4.1	175	238	53		M16 x 90	3.0
5	5.563	750	18220	0 ~ 0.16	6.97	9.45	2.09	2	¾ x 3½	6.6
125	141.3	52	81.50	0~4.1	177	240	53	2	M16 x 90	3.0
165.1 mm	6.500	700	23210	0 ~ 0.16	7.87	10.47	2.09	2	¾ x 3½	7.5
	165.1	48	102.71	0~4.1	200	266	53		M16 x 90	3.4
6	6.625	700	24110	0 ~ 0.16	8.00	10.67	2.09	2	¾ x 3½	7.1
150	168.3	48	106.73	0~4.1	203	271	53	2	M16 x 90	3.2
8	8.625	600	35030	0 ~ 0.19	10.55	13.46	2.52	2	¾ x 4¾	15.7
200	219.1	42	158.27	0~4.8	268	342	64	2	M20 x 120	7.1
10	10.750	500	45350	0 ~ 0.13	12.86	15.60	2.56	2	¾ x 6½	27.4
250	273.0	35	204.77	0~3.2	327	396	65		—	10.4
12	12.750	400	51040	0 ~ 0.13	14.86	17.80	2.56	2	¾ x 6½	26.0
300	323.9	28	230.59	0~3.2	377	452	65	2	—	11.8
200 JIS	8.516	600	34150	0 ~ 0.13	10.39	13.35	2.50	2	¾ x 4¾	16.3
	216.3	42	154.25	0~3.2	264	339	64		M20 x 120	7.4
250 JIS	10.528	500	43500	0 ~ 0.13	12.63	15.63	2.56	2	¾ x 6½	23.1
	267.4	35	196.45	0~3.2	321	397	65		—	10.5
300 JIS	12.539	400	49360	0 ~ 0.13	14.65	17.80	2.56	2	¾ x 6½	27.4
	318.5	28	222.97	0~3.2	372	452	65		—	12.4

* Working Pressure is based on roll grooved standard wall carbon steel pipe.

† Allowable Axial Displacement and Angular Movement (deflection) figures are for roll grooved standard steel pipe. Values for cut grooved pipe will be double that of roll grooved. These values are maximums; for design and installation purposes these figures should be reduced by: 50% for ¾" - 3½"; 25% for 4" and larger to compensate for jobsite conditions.

Model Z07N Heavy Duty Rigid Coupling

The Shurjoint Model Z07N is a two-segment, rigid coupling for general piping applications where rigidity is required. Sizes 14" - 24" are now available.

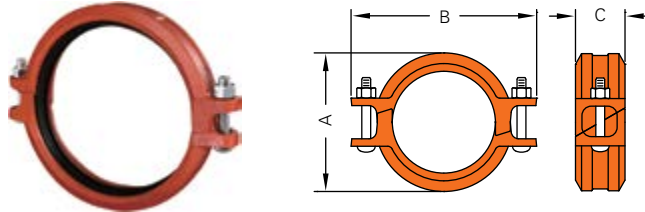

Nominal Size	Pipe O.D.	Max. Working Pressure (CWP)*	Max. End Load (CWP)	Axial Displacement †	Dimensions			Bolt		Weight
					A	B	C	No.	Size	
in	in	PSI	Lbs	in	in	in	in	in	Lbs	
mm	mm	Bar	kN	mm	mm	mm	mm	mm	Kgs	
14	14.000	250	38460	0 - 0.13	16.06	20.00	2.95	2	7/8 x 5 1/2	35.3
350	355.6	17	168.75	0-3.2	408	508	75	2	---	16.0
16	16.000	250	50240	0 - 0.13	18.39	22.05	2.95	2	7/8 x 5 1/2	30.5
400	406.4	17	220.41	0-3.2	467	660	75	2	---	17.9
18	18.000	250	63580	0 - 0.13	20.68	24.29	3.11	2	7/8 x 5 1/2	40.1
450	457.2	17	278.95	0-3.2	525	617	79	2	---	22.3
20	20.000	250	78500	0 - 0.13	22.93	27.99	3.00	2	1 x 5 1/2	57.8
500	508.0	17	344.39	0-3.2	582	711	76	2	---	26.2
24	24.000	250	113040	0 - 0.13	27.05	30.55	3.06	2	1 x 5 1/2	70.8
600	609.6	17	495.92	0-3.2	687	776	78	2	---	32.1

* Working Pressure is based on roll grooved standard wall carbon steel pipe.

† Allowable Axial Displacement and Angular Movement (deflection) figures are for roll grooved standard steel pipe. Values for cut grooved pipe will be double that of roll grooved. These values are maximums; for design and installation purposes these figures should be reduced by: 50% for 3/4" - 3 1/2"; 25% for 4" and larger to compensate for jobsite conditions.

Model 7771 Standard Rigid Coupling - T & G Design

The Shurjoint Model 7771 is a T&G (tongue & groove) design standard rigid coupling for general piping applications where rigidity is required including valve connections, mechanical rooms, fire mains and long straight runs. The T&G mechanism provides a rigid, locked-in connection that resists flexural and torsional loads.

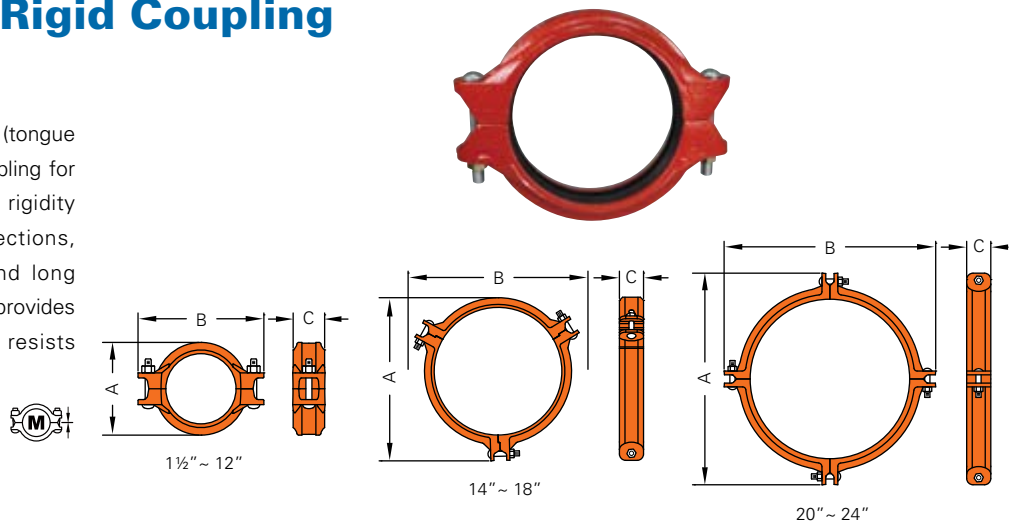

Nominal Size	Pipe O.D.	Max. Working Pressure (CWP)**	Max. End Load (CWP)	Axial Displacement †	Dimensions			Bolt		Weight
					A	B	C	No.	Size	
in	in	PSI	Lbs	in	in	in		in	Lbs	
mm	mm	Bar	kN	mm	mm	mm		mm	Kgs	
1 1/2	1.900	500	1410	0~0.06	2.91	4.41	1.81	2	3/8 x 2 1/2	1.5
40	48.3	35	6.23	0~1.6	74	112	46	2	M10 x 55	0.7
2	2.375	500	2210	0~0.06	3.34	4.96	1.81	2	3/8 x 2 1/2	1.9
50	60.3	35	9.70	0~1.6	85	126	46	2	M10 x 55	0.9
2 1/2	2.875	500	3240	0~0.06	3.89	5.59	1.81	2	3/8 x 2 1/2	2.6
65	73.0	35	14.22	0~1.6	99	142	46	2	M10 x 55	1.2
76.1 mm	3.000	500	3530	0~0.06	4.00	5.90	1.81	2	3/8 x 2 1/2	2.6
	76.1	35	15.46	0~1.6	102	150	46		M10 x 55	1.2
3	3.500	500	4800	0~0.06	4.52	6.50	1.81	2	1/2 x 3	3.3
80	88.9	35	21.09	0~1.6	115	165	46	2	M12 x 75	1.5
108.0 mm	4.250	500	7090	0~0.16	5.54	7.59	2.00	2	1/2 x 3	4.8
	108.0	35	31.13	0~4.1	141	193	51		M12 x 75	2.2
4	4.500	500	7940	0~0.16	5.82	7.79	2.00	2	1/2 x 3	4.8
100	114.3	35	34.87	0~4.1	148	198	51	2	M12 x 75	2.2
133.0 mm	5.250	450	9730	0~0.16	6.61	9.72	2.00	2	5/8 x 3 1/2	6.0
	133.0	31	43.05	0~4.1	168	247	51		M16 x 90	2.7
139.7 mm	5.500	450	10680	0~0.16	6.8	9.45	2.00	2	5/8 x 3 1/2	6.4
	139.7	31	47.49	0~4.1	173	240	51		M16 x 90	2.9
5	5.563	450	10930	0~0.16	6.88	9.84	2.00	2	5/8 x 3 1/2	6.4
125	141.3	31	48.59	0~4.1	175	250	51	2	M16 x 90	2.9
165.1 mm	6.500	450	14920	0~0.16	7.87	11.02	2.09	2	5/8 x 3 1/2	7.7
	165.1	31	66.33	0~4.1	200	280	53		M16 x 90	3.5
6	6.625	450	15500	0~0.16	8.07	11.18	2.09	2	5/8 x 3 1/2	8.1
150	168.3	31	68.93	0~4.1	205	284	53	2	M16 x 90	3.7
8	8.625	300	17510	0~0.16	10.27	13.58	2.48	2	5/8 x 5	14.6
200	219.1	20	75.37	0~4.1	261	345	63	2	M16 x 135	6.6
10	10.750	300	27210	0~0.16	12.44	15.51	2.50	2	3/4 x 4 3/4	18.6
250	273.0	20	117.01	0~4.1	316	394	64		M20 x 120	8.4
12	12.750	300	38280	0~0.16	14.17	18.00	2.50	2	7/8 x 6 1/2	24.5
300	323.9	20	164.71	0~4.1	360	457	64		---	11.1
200 JIS	8.516	300	17070	0~0.16	10.00	13.58	2.48	2	5/8 x 5	15.2
	216.3	20	73.45	0~4.1	254	345	63		M16 x 135	6.9
250 JIS	10.528	300	26100	0~0.16	12.20	15.20	2.50	2	3/4 x 4 3/4	19.3
	267.4	20	112.26	0~4.1	310	386	64		M20 x 120	8.7
300 JIS	12.539	300	37020	0~0.16	13.94	17.48	2.50	2	7/8 x 6 1/2	26.0
	318.5	20	159.26	0~4.1	354	444	64		---	11.2
14	14.000	300	46150	0~0.13	16.25	20.28	2.95	3	7/8 x 4	31.9
350	355.6	20	198.53	0~3.2	413	515	75		---	14.5
16	16.000	300	60280	0~0.13	18.11	22.17	2.95	3	7/8 x 4	35.2
400	406.4	20	259.30	0~3.2	460	563	75		---	16.0
18	18.000	300	76300	0~0.13	20.51	24.21	3.11	3	7/8 x 4	37.4
450	457.2	20	328.18	0~3.2	521	615	79		---	17.0
20	20.000	300	94200	0~0.13	22.87	26.26	3.11	4	1 x 3 1/2	52.8
500	508.0	20	405.16	0~3.2	581	667	79		---	24.0
22	22.000	250	94980	0~0.13	24.49	28.35	3.11	4	1 x 3 1/2	58.3
550	558.8	17	416.71	0~3.2	622	720	79		---	26.5
24	24.000	250	113040	0~0.13	27.12	30.24	3.11	4	1 x 3 1/2	62.6
600	609.6	17	495.92	0~3.2	689	768	79		---	28.4

** Working Pressure is based on roll grooved standard wall carbon steel pipe.

† Allowable Axial Displacement and Angular Movement (deflection) figures are for roll grooved standard steel pipe. Values for cut grooved pipe will be double that of roll grooved. These values are maximums; for design and installation purposes these figures should be reduced by: 50% for 3/4" - 3 1/2"; 25% for 4" and larger to compensate for jobsite conditions.

Model XH-1000 Extra Heavy Rigid Coupling

The Shurjoint Model XH-1000 is an extra heavy rigid coupling designed for high pressure services up to 1000 psi (70 Bar). This coupling is painted orange and is supplied with a standard C-shaped gasket and heavy duty bolts and nuts. The Model XH-1000 can be installed on standard roll or

cut grooved pipes or components. Sizes 2" through 4" require a bolt torque of 60 - 70 Lbs-Ft. with some bolt gaps. For sizes 6" and above, the bolt pads will make metal to metal contact when properly installed with no torque wrench required.

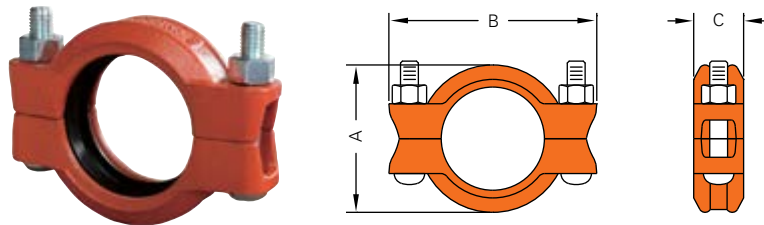
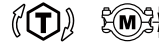

Nominal Size	Pipe O.D.	Max. Working Pressure (CWP)*	Max. End Load (CWP)	Axial Displacement †	Dimensions			Bolt		Weight
					A	B	C	No.	Size	
in	in	PSI	Lbs	in	in	in	in		in	Lbs
mm	mm	Bar	kN	mm	mm	mm	mm			Kgs
2	2.375	1000	4420	0 ~ 0.14	3.50	5.71	1.92	2	5/8 x 2 3/4	3.4
50	60.3	69	19.98	0 ~ 3.6	90	145	49			1.6
2 1/2	2.875	1000	6480	0 ~ 0.14	4.02	6.61	1.92	2	5/8 x 2 3/4	3.8
65	73.0	69	29.28	0 ~ 3.6	102	168	49			1.7
3	3.500	1000	9610	0 ~ 0.14	4.86	7.40	1.92	2	5/8 x 2 3/4	4.8
80	88.9	69	43.43	0 ~ 3.6	123	188	49			2.2
4	4.500	1000	15890	0 ~ 0.25	6.09	8.74	2.10	2	3/4 x 4 1/2	8.4
100	114.3	69	71.79	0 ~ 6.4	155	222	53			3.8
6	6.625	1000	34450	0 ~ 0.25	8.58	11.61	2.25	2	7/8 x 5 1/2	17.6
150	168.3	69	155.65	0 ~ 6.4	218	295	57			8.0
8	8.625	800	46710	0 ~ 0.25	10.83	14.33	2.75	2	1 x 5 1/2	24.0
200	219.1	55	207.26	0 ~ 6.4	275	364	70			10.9
10	10.750	800	72570	0 ~ 0.25	13.15	16.70	2.95	2	1 x 5 1/2	31.2
250	273.0	55	321.78	0 ~ 6.4	334	424	75			14.2
12	12.750	800	102080	0 ~ 0.25	15.35	18.90	2.95	2	1 x 5 1/2	36.7
300	323.9	55	452.95	0 ~ 6.4	390	480	75			16.7

* Working Pressure is based on roll grooved standard wall carbon steel pipe. Stated pressure ratings have been developed with a safety factor. Please see Shurjoint's 2017 online installation instructions for most recently updated instructions. Proper installation is important to proper performance.

† Allowable Axial Displacement and Angular Movement (deflection) figures are for roll grooved standard steel pipe. Values for cut grooved pipe will be double that of roll grooved. These values are maximums; for design and installation purposes these figures should be reduced by: 50% for 3/4" - 3 1/2"; 25% for 4" and larger to compensate for jobsite conditions.



Sizes 2" through 4" require a bolt torque of 60 - 70 Lbs-Ft (80 - 95 Nm). Normally you can see some gaps between the bolt pads. Bolt pad gaps should be equal on both sides of the coupling.



Sizes 6" through 12" are designed to make a metal-to-metal contact when properly installed.

Model 7705 Flexible Coupling

The Shurjoint Model 7705 is a standard flexible coupling designed for use in a variety of moderate pressure general piping applications. The Model 7705 coupling features flexibility that can accommodate misalignment, distortion, thermal stress, vibration, noise and seismic tremors. The Model 7705 can even accommodate an arced or curved piping layout. See Typical Applications - Flexible Couplings on page 191.

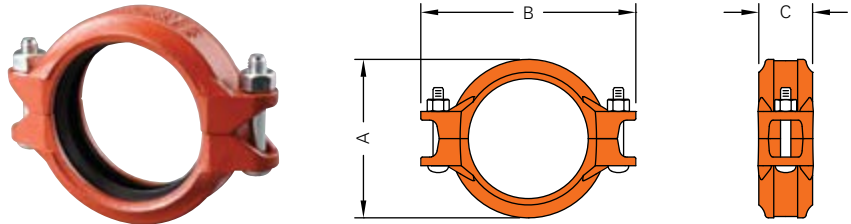

Nominal Size	Pipe O.D.	Max. Working Pressure (CWP)*	Max. End Load (CWP)	Axial Displacement †	Angular Movement**††		Dimensions			Bolt Size	Weight
					Degree Per Coupling	Per Pipe	A	B	C		
in	in	PSI	Lbs	in	(°)	in/ft	in	in	in	in	Lbs
mm	mm	Bar	kN	mm		mm/m	mm	mm	mm	mm	Kgs
1	1.315	500	670	0.0625	2° - 45°	0.58	2.24	3.94	1.81	3/8 x 1 1/4	1.3
25	33.4	35	3.12	1.6		48	57	100	46	M10 x 45	0.6
1 1/4	1.660	500	1080	0.0625	2° - 10°	0.46	2.60	4.06	1.81	3/8 x 2 1/4	1.5
32	42.2	35	4.94	1.6		38	66	103	46	M10 x 55	0.7
1 1/2	1.900	500	1410	0.0625	1° - 54°	0.4	2.83	4.25	1.81	3/8 x 2 1/4	1.6
40	48.3	35	6.41	1.6		33	72	108	46	M10 x 55	0.7
2	2.375	500	2210	0.0625	1° - 31°	0.32	3.31	5.08	1.85	3/8 x 2 1/4	1.8
50	60.3	35	9.99	1.6		27	84	129	47	M10 x 55	0.8
2 1/2	2.875	500	3240	0.0625	1° - 15°	0.26	3.90	5.59	1.85	3/8 x 2 1/4	2.0
65	73.0	35	14.64	1.6		22	99	142	47	M10 x 55	0.9
76.1 mm	3.000	500	3530	0.0625	1° - 12°	0.25	4.02	5.79	1.85	3/8 x 2 1/4	2.1
	76.1	35	15.91	1.6		21	102	147	47	M10 x 55	1.0
3	3.500	500	4800	0.0625	1° - 02°	0.22	4.57	6.46	1.85	1/2 x 3	2.8
80	88.9	35	21.71	1.6		18	116	164	47	M12 x 75	1.3
101.6 mm	4.000	500	6280	0.0625	0° - 54°	0.19	5.07	7.24	1.85	1/2 x 3	3.6
	101.6	35	28.36	1.6		16	129	184	47	M12 x 75	1.6
108.0 mm	4.250	500	7080	0.1250	1° - 42°	0.36	5.43	7.56	2.05	1/2 x 3	4.1
	108.0	35	32.05	3.2		30	138	192	52	M12 x 75	1.9
4	4.500	500	7940	0.1250	1° - 36°	0.34	5.71	7.76	2.05	1/2 x 3	4.1
100	114.3	35	35.89	3.2		28	145	197	52	M12 x 75	1.9
133.0 mm	5.250	450	9730	0.1250	1° - 23°	0.29	6.50	9.09	2.05	5/8 x 3 1/2	5.1
	133.0	31	43.05	3.2		24	165	231	52	M16 x 90	2.3
139.7 mm	5.500	450	10680	0.1250	1° - 18°	0.28	6.69	9.76	2.05	5/8 x 3 1/2	5.9
	139.7	31	47.49	3.2		23	170	248	52	M16 x 90	2.7
5	5.563	450	10930	0.1250	1° - 18°	0.27	6.77	9.17	2.05	5/8 x 3 1/2	5.9
125	141.3	31	48.59	3.2		23	172	233	52	M16 x 90	2.7
159.0 mm	6.250	450	13790	0.1250	1° - 09°	0.24	7.48	9.96	2.05	5/8 x 3 1/2	6.6
	159.0	31	61.52	3.2		20	190	253	52	M16 x 90	3.0
165.1 mm	6.500	450	14920	0.1250	1° - 07°	0.24	7.72	10.28	2.09	5/8 x 3 1/2	6.8
	165.1	31	66.33	3.2		20	196	261	53	M16 x 90	3.1
6	6.625	450	15500	0.1250	1° - 05°	0.23	7.87	10.55	2.09	5/8 x 3 1/2	7.0
150	168.3	31	68.93	3.2		19	200	268	53	M16 x 90	3.2
8	8.625	300	17510	0.1250	0° - 50°	0.18	10.24	13.27	2.44	5/8 x 3 1/2	12.8
200	219.1	20	75.37	3.2		15	260	337	62	M16 x 90	5.8
8 (7705H)	8.625	450	26270	0.1250	0° - 50°	0.18	10.47	13.07	2.44	3/4 x 4 1/4	15.7
200	219.1	31	116.82	3.2		15	266	332	62	M20 x 120	7.1
10	10.750	300	27210	0.1250	0° - 40°	0.14	12.64	15.59	2.56	3/4 x 4 1/4	18.0
250	273.0	20	117.01	3.2		12	321	396	65	M20 x 120	8.2
12	12.750	300	38280	0.1250	0° - 34°	0.12	14.56	17.72	2.56	7/8 x 6 1/2	23.8
300	323.9	20	164.71	3.2		10	372	450	65	---	10.8
200 JIS	8.516	300	17079	0.1250	0° - 51°	0.18	10.00	13.70	2.36	3/4 x 4 1/4	12.8
	216.3	20	73.45	3.2		15	254	348	60	M20 x 120	5.8
250 JIS	10.528	300	26103	0.1250	0° - 41°	0.15	13.27	15.28	2.56	3/4 x 4 1/4	17.6
	267.4	20	112.26	3.2		12	337	388	65	M20 x 120	8.0
300 JIS	12.539	300	37027	0.1250	0° - 35°	0.12	15.31	17.48	2.56	7/8 x 6 1/2	22.6
	318.5	20	159.26	3.2		10	389	444	65	---	10.3

All DIN size 7705 couplings up to DN150 size and the DN200 7705H coupling are VdS approved in addition to cULus and FM approvals.

* Working Pressure is based on roll grooved standard wall carbon steel pipe.

† Allowable Axial Displacement and Angular Movement (deflection) figures are for roll grooved standard steel pipe. Values for cut grooved pipe will be double that of roll grooved. These values are maximums; for design and installation purposes these figures should be reduced by: 50% for 3/4"/DN20 - 3 1/2"/DN90; 25% for 4"/DN100 and larger to compensate for jobsite conditions.

** Deflection or angular movement given is the maximum value that a coupling allows. When using the given maximum angles for a curved layout, proper bracing should be used to counter pressure thrust that will occur when the system is pressurized. Flexible couplings can be used for angular movement and/or thermal expansion, though please note individual coupling(s) cannot be used to their maximums for both types of movement within a system at the same time.

Model 7707 Heavy Duty Flexible Coupling

The Shurjoint Model 7707 heavy duty flexible coupling is designed for use in a variety of general piping applications of moderate or high pressure services. Working pressure is usually dictated by

the wall thickness and rating of the pipe being used. The Model 7707 couplings feature flexibility that can accommodate misalignment, distortion, thermal stress, vibration, noise and seismic tremors. The

Model 7707 can even accommodate an arced or curved piping layout. See Typical Applications - Flexible Couplings on page 191.

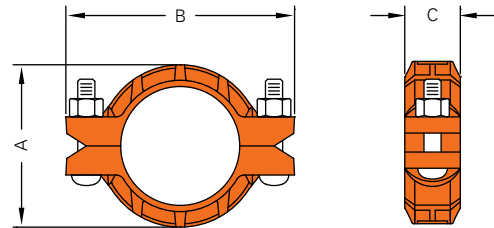
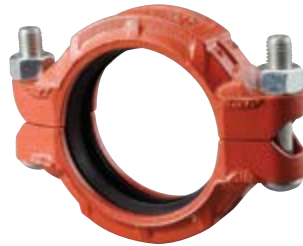

¾"~12"

Nominal Size	Pipe O. D.	Max. Working Pressure (CWP)**	Max. End Load (CWP)	Axial Displacement †	Angular Movement ††		Dimensions			Bolts		Weight
					Degree Per Coupling	Per Pipe	A	B	C	No.	Size	
in mm	in mm	PSI Bar	Lbs kN	in mm	(°)	in / ft mm / m	in mm	in mm	in mm		in mm	Lbs Kgs
¾	1.050	1000	865	0.0625	3° - 23'	0.71	2.13	3.74	1.81	2	¾ x 2½	1.3
20	26.7	69	3.79	1.6		58	54	95	46		M10x55	0.6
1	1.315	1000	1360	0.0625	2° - 45'	0.58	2.40	4.02	1.81	2	¾ x 2½	1.7
25	33.4	69	6.15	1.6		48	61	102	46		M10x55	0.8
1½	1.660	1000	2160	0.0625	2° - 10'	0.45	2.76	4.45	1.81	2	½ x 3	2.1
32	42.2	69	9.64	1.6		38	70	113	46		M12x75	1.0
1½	1.900	1000	2830	0.0625	1° - 54'	0.40	3.00	4.57	1.81	2	½ x 2¾	2.1
40	48.3	69	12.64	1.6		33	76	116	46		M12x60	1.0
2	2.375	1000	4430	0.0625	1° - 31'	0.31	3.50	5.35	1.81	2	½ x 3	2.6
50	60.3	69	19.69	1.6		26	90	136	46		M12x75	1.2
2½	2.875	1000	6490	0.0625	1° - 15'	0.26	4.00	5.98	1.85	2	½ x 3	2.9
65	73.0	69	28.86	1.6		22	102	152	47		M12x75	1.3
76.1 mm	3.000	1000	7065	0.0625	1° - 12'	0.25	4.06	6.02	1.85	2	½ x 3	2.9
	76.1	69	31.37	1.6		21	103	153	47		M12x75	1.3
3	3.500	1000	9620	0.0625	1° - 02'	0.21	4.88	6.34	1.85	2	½ x 3	3.3
80	88.9	69	42.81	1.6		18	124	161	47		M12x75	1.5
4	4.500	1000	15900	0.1250	1° - 36'	0.33	6.18	8.03	2.05	2	¾ x 3½	4.6
100	114.3	69	70.76	3.2		27	157	204	52		M16x90	2.1
139.7 mm	5.500	1000	23750	0.1250	1° - 18'	0.27	7.32	9.41	2.09	2	¾ x 3½	6.8
	139.7	69	105.71	3.2		23	186	239	53		M16x90	3.1
5	5.563	1000	24295	0.1250	1° - 18'	0.27	7.32	9.65	2.09	2	¾ x 3½	7.2
	125	141.3	69	108.14		3.2	22	186	245		53	M16x90
165.1 mm	6.500	1000	33170	0.1250	1° - 07'	0.23	8.11	10.24	2.09	2	¾ x 4¾	7.9
	165.1	69	147.64	3.2		19	211	260	53		M20x120	3.6
6	6.625	1000	34455	0.1250	1° - 05'	0.22	8.24	10.75	2.09	2	¾ x 4¾	8.1
150	168.3	69	153.42	3.2		19	214	273	53		M20x120	3.7
8	8.625	800	46720	0.1250	0° - 50'	0.18	10.86	13.23	2.44	2	¾ x 4¾	14.5
200	219.1	55	207.26	3.2		15	276	336	62		M20x120	6.6
10	10.750	800	72575	0.1250	0° - 40'	0.14	13.50	16.10	2.56	2	¾ x 6½	23.3
250	273.0	55	321.78	3.2		11	343	409	65		---	10.6
12	12.750	800	102090	0.1250	0° - 34'	0.12	15.35	18.50	2.60	2	¾ x 6½	26.4
300	323.9	55	452.95	3.2		10	390	470	66		---	12.0
200 JIS	8.516	800	45545	0.1250	0° - 51'	0.18	10.86	13.03	2.36	2	¾ x 4¾	13.9
	216.3	55	202.00	3.2		15	276	331	60		M20x120	6.3
250 JIS	10.528	800	69610	0.1250	0° - 41'	0.14	13.27	15.87	2.60	2	¾ x 6½	22.4
	267.4	55	308.71	3.2		12	337	403	66		---	10.2
300 JIS	12.539	800	98740	0.1250	0° - 35'	0.12	15.31	18.11	2.60	2	¾ x 6½	25.5
	318.5	55	437.98	3.2		10	389	460	66		---	11.6

** Working Pressure is based on roll grooved standard wall carbon steel pipe.

† Allowable Axial Displacement and Angular Movement (deflection) figures are for roll grooved standard steel pipe. Values for cut grooved pipe will be double that of roll grooved. These values are maximums; for design and installation purposes these figures should be reduced by: 50% for ¾" - 3½"; 25% for 4" and larger to compensate for jobsite conditions.

** Deflection or angular movement given is the maximum value that a coupling allows. When using the given maximum angles for a curved layout, proper bracing should be used to counter pressure thrust that will occur when the system is pressurized. Flexible couplings can be used for angular movement and or thermal expansion, though please note individual coupling(s) cannot be used to their maximums for both types of movement within a system at the same time.

* Non-standard/stock items may require longer lead time.

Model 7707N Flexible Coupling

The Shurjoint Model 7707N is a two-segment, flexible coupling for use with standard pipe, roll or cut grooved to AWWA C606 specifications. For 26", see page 189 for groove dimensions.



14" ~ 24"

26"

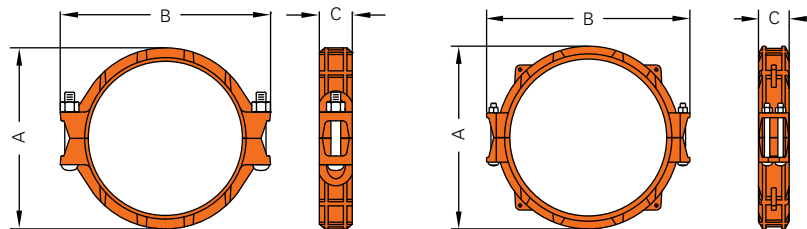

14" ~ 24"

26"

Nominal Size	Pipe O.D.	Max. Working Pressure (CWP)*	Max. End Load (CWP)	Axial Displacement †	Angular Movement**††		Dimensions			Bolt		Weight
					Degree Per Coupling	Per Pipe	A	B	C	No.	Size	
in	in	PSI	Lbs	in	(°)	in / ft	in	in	in		in	Lbs
mm	mm	Bar	kN	mm		mm / m	mm	mm	mm			Kgs
14	14.00	300	46150	0.125	0° - 31'	0.06	16.23	19.80	2.95	2	¾ x 6½	34.5
350	355.6	20	198.53	3.2		4.5	412.0	503.0	75.0			15.7
16	16.00	300	60280	0.125	0° - 27'	0.05	18.23	21.85	2.95	2	1 x 6½	37.0
400	406.4	20	259.30	3.2		4.0	463.0	555.0	75.0			16.8
18	18.00	300	76300	0.125	0° - 24'	0.04	20.45	24.06	3.11	2	1 x 6½	47.1
450	457.2	20	327.89	3.2		3.5	520.0	611.0	79.0			22.3
20	20.00	300	94200	0.125	0° - 22'	0.04	22.48	26.38	3.11	2	1 x 6½	54.4
500	508.0	20	405.16	3.2		3.0	571.0	670.0	79.0			24.7
22	22.00	300	113980	0.125	0° - 19'	0.04	24.46	30.16	3.11	2	1½ x 6½	63.0
550	558.8	20	490.60	3.2		3.0	621.4	766.0	79.0			28.6
24	24.00	300	135640	0.125	0° - 18'	0.03	26.55	30.43	3.11	2	1½ x 6½	65.1
600	609.6	20	584.20	3.2		2.5	674.0	773.0	79.0			29.5
26	26.00	300	159190	0.125	0° - 17'	0.03	29.68	33.15	4.94	4	¾ x 9¾	143.0
650	660.4	20	684.72	3.2		2.5	754.0	842.0	125.6			65.0

* Working pressure is based on roll-grooved standard wall carbon steel pipe.

Pressure ratings are based on cut-grooved XS carbon steel pipe, refer to page 51 on STD & LW carbon steel pipes.

† Allowable Axial Displacement and Angular Movement (deflection) figures are for roll grooved standard steel pipe. Values for cut grooved pipe will be double that of roll grooved. These values are maximums; for design and installation purposes these figures should be reduced by: 50% for ¾" - 3½"; 25% for 4" and larger to compensate for jobsite conditions.

** Deflection or angular movement given is the maximum value that a coupling allows. When using the given maximum angles for a curved layout, proper bracing should be used to counter pressure thrust that will occur when the system is pressurized. Flexible couplings can be used for angular movement and or thermal expansion, though please note individual coupling(s) cannot be used to their maximums for both types of movement within a system at the same time.

Model 7707L Large Diameter Coupling

The Shurjoint Model 7707L large diameter couplings in sizes 28" - 42" (700 mm - 1050 mm) are designed for joining large diameter IPS pipe that can be roll grooved. All couplings feature a six to eight segment design, incorporating two bolts at each segment joint to ensure a positive connection and seal.

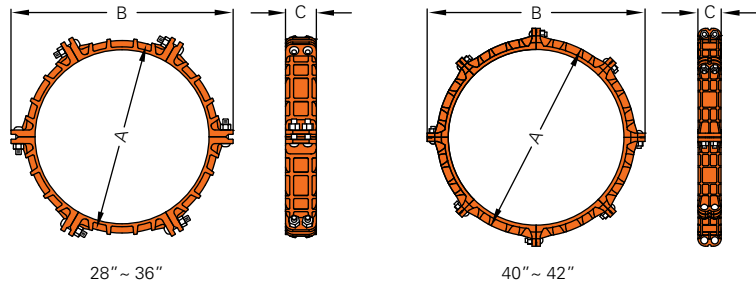

Nominal Size	Pipe O.D.	Max. Working Pressure (CWP)*	Max. End Load (CWP)	Axial Displacement †	Angular Movement**†		Dimensions			Bolt		Weight
					Degree Per Coupling	Per Pipe	A	B	C	No.	Size	
in	in	PSI	Lbs	in	(°)	in / ft	in	in	in		in	Lbs
mm	mm	Bar	kN	mm		mm / m	mm	mm	mm			Kgs
28	28.0	175	107700	0.250	---	---	32.0	35.98	5.0	12	7/8 x 4	180
700	711.2	12	476.47	6.4	---	---	813	914	127	12	7/8 x 4	82
30	30.0	175	123630	0.250	---	---	34.0	38.07	5.0	12	7/8 x 4	209
750	762.0	12	546.97	6.4	---	---	864	967	127	12	7/8 x 4	95
32	32.0	175	140670	0.250	---	---	36.0	40.08	5.0	12	7/8 x 4	207
800	812.8	12	622.33	6.4	---	---	914	1018	127	12	7/8 x 4	94
34	34.0	175	158800	0.250	---	---	38.3	42.00	5.0	12	7/8 x 4	198
850	863.6	12	702.55	6.4	---	---	974	1066	127	12	7/8 x 4	90
36	36.0	175	178030	0.250	---	---	40.0	44.02	5.0	12	7/8 x 4	212
900	914.4	12	787.63	6.4	---	---	1016	1118	127	12	7/8 x 4	96
40	40.0	175	219800	0.250	---	---	43.5	49.49	5.4	16	1 x 3 1/2	271
1000	1016.0	12	972.39	6.4	---	---	1105	1257	138	16	1 x 3 1/2	123
42	42.0	175	242330	0.250	---	---	45.5	51.57	5.4	16	1 x 3 1/2	313
1050	1066.8	12	1072.05	6.4	---	---	1156	1310	138	16	1 x 3 1/2	142

* Working pressure is based on roll-grooved standard wall carbon steel pipe.

Pressure ratings are based on cut-grooved XS carbon steel pipe, refer to page 51 on STD & LW carbon steel pipes.

† Allowable Axial Displacement and Angular Movement (deflection) figures are for roll grooved standard steel pipe. Values for cut grooved pipe will be double that of roll grooved. These values are maximums; for design and installation purposes these figures should be reduced by: 50% for 3/4" - 3 1/2"; 25% for 4" and larger to compensate for jobsite conditions.

** Deflection or angular movement given is the maximum value that a coupling allows. When using the given maximum angles for a curved layout, proper bracing should be used to counter pressure thrust that will occur when the system is pressurized. Flexible couplings can be used for angular movement and or thermal expansion, though please note individual coupling(s) cannot be used to their maximums for both types of movement within a system at the same time.

Model 7706 Reducing Coupling

The Shurjoint Model 7706 reducing coupling allows for direct reduction on a piping run and eliminates the need for a concentric reducer and additional couplings.

The specially designed rubber gasket helps prevent small pipe from telescoping into larger pipe during vertical assembly.



Caution: The Model 7706 couplings must not be used with an end cap, as the end cap could be sucked into the pipe by the vacuum created when a system is being drained.

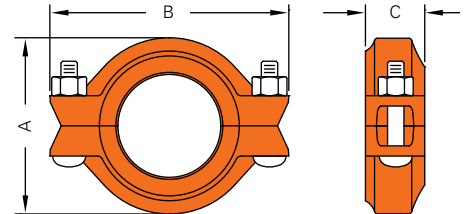
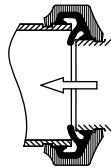

Nominal Size	Pipe O.D.	Max. Working Pressure (CWP)*	Max. End Load (CWP)	Axial Displacement †	Angular Movement**†		Dimensions			Bolt Size	Weight
					Degree Per Coupling	Per Pipe	A	B	C		
in mm	in mm	PSI Bar	Lbs kN	in mm	(°)	in / ft mm / m	in mm	in mm	in mm	in mm	Lbs Kgs
1½ x 1¼ 40 x 32	1.900 x 1.660 48.3 x 42.2	500 35	1410 6.23	0 ~ 0.065 0 ~ 1.6	1° - 54'	0.20 17	2.83 72	4.65 118	1.81 46	¾ x 2½ M10 x 55	1.8 0.8
2 x 1½ 50 x 40	2.375 x 1.900 60.3 x 48.3	500 35	2210 9.70	0 ~ 0.065 0 ~ 1.6	1° - 31'	0.16 13	3.35 85	4.80 122	1.89 48	¾ x 2½ M10 x 55	2.0 0.9
2½ x 2 65 x 50	2.875 x 2.375 73.0 x 60.3	500 35	3240 14.22	0 ~ 0.065 0 ~ 1.6	1° - 15'	0.13 11	3.78 96	5.67 144	1.89 48	¾ x 2½ M10 x 55	2.6 1.2
76.1 mm x 50	3.000 x 2.375 76.1 x 60.3	500 35	3530 15.46	0 ~ 0.065 0 ~ 1.6	1° - 12'	0.13 11	4.02 102	5.67 144	1.89 48	¾ x 2½ M10 x 55	2.6 1.2
3 x 2 80 x 50	3.500 x 2.375 88.9 x 60.3	500 35	4800 21.09	0 ~ 0.065 0 ~ 1.6	1° - 02'	0.11 9	4.57 116	6.61 168	1.89 48	½ x 3 M12 x 75	3.3 1.5
3 x 2½ 80 x 65	3.500 x 2.875 88.9 x 73.0	500 35	4800 21.09	0 ~ 0.065 0 ~ 1.6	1° - 02'	0.11 9	4.57 116	6.61 168	1.89 48	½ x 3 M12 x 75	3.7 1.7
80 x 76.1 mm	3.500 x 3.000 88.9 x 76.1	500 35	4800 21.09	0 ~ 0.065 0 ~ 1.6	1° - 02'	0.11 9	4.57 116	6.61 168	1.89 48	½ x 3 M12 x 75	3.7 1.7
4 x 2 100 x 50	4.500 x 2.375 114.3 x 60.3	500 35	7940 34.87	0 ~ 0.095 0 ~ 2.4	1° - 12'	0.13 11	5.75 146	7.80 198	1.93 49	½ x 3 M12 x 75	5.3 2.4
4 x 2½ 100 x 65	4.500 x 2.875 114.3 x 73.0	500 35	7940 34.87	0 ~ 0.095 0 ~ 2.4	1° - 12'	0.13 11	5.75 146	7.80 198	1.93 49	½ x 3 M12 x 75	5.7 2.6
100 x 76.1 mm	4.500 x 3.000 114.3 x 76.1	500 35	7940 34.87	0 ~ 0.095 0 ~ 2.4	1° - 12'	0.13 11	5.75 146	7.80 198	1.93 49	½ x 3 M12 x 75	5.7 2.6
4 x 3 100 x 80	4.500 x 3.500 114.3 x 88.9	500 35	7940 34.87	0 ~ 0.095 0 ~ 2.4	1° - 12'	0.13 11	5.75 146	7.80 198	2.01 51	½ x 3 M12 x 75	5.3 2.4
139.7 mm x 100	5.500 x 4.500 139.7 x 114.3	400 28	9490 42.90	0 ~ 0.125 0 ~ 3.2	1° - 18'	0.14 12	6.30 160	9.45 240	2.01 51	¾ x 3½ M16 x 90	8.4 3.8
5 x 4 125 x 100	5.563 x 4.500 141.3 x 114.3	400 28	9710 43.88	0 ~ 0.125 0 ~ 3.2	1° - 18'	0.14 12	6.30 160	9.84 242	2.01 51	¾ x 3½ M16 x 90	7.9 3.6
165.1 mm x 80	6.500 x 3.500 165.1 x 88.9	400 28	13260 59.91	0 ~ 0.125 0 ~ 3.2	1° - 07'	0.12 10	7.95 202	10.63 270	2.05 52	¾ x 3½ M16 x 90	10.1 4.6
6 x 3 150 x 80	6.625 x 3.500 168.3 x 88.9	400 28	13780 62.26	0 ~ 0.125 0 ~ 3.2	1° - 06'	0.12 10	8.19 208	10.63 270	2.05 52	¾ x 3½ M16 x 90	10.1 4.6
165.1 mm x 100	6.500 x 4.500 165.1 x 114.3	400 28	13260 59.91	0 ~ 0.125 0 ~ 3.2	1° - 07'	0.12 10	7.95 202	10.67 271	2.05 52	¾ x 3½ M16 x 90	9.9 4.5
6 x 4 150 x 100	6.625 x 4.500 168.3 x 114.3	400 28	13780 62.26	0 ~ 0.125 0 ~ 3.2	1° - 06'	0.12 10	8.19 208	10.63 270	2.05 52	¾ x 3½ M16 x 90	9.9 4.5
8 x 6 200 x 150	8.625 x 6.625 219.1 x 168.3	400 28	23350 105.51	0 ~ 0.125 0 ~ 3.2	0° - 50'	0.09 8	10.24 260	13.11 333	2.09 53	¾ x 4¾ M20 x 120	14.3 6.5
200 x 165.1 mm	8.625 x 6.500 219.1 x 165.1	400 28	23350 105.51	0 ~ 0.125 0 ~ 3.2	0° - 50'	0.09 8	10.24 260	13.11 333	2.20 56	¾ x 4¾ M20 x 120	14.3 6.5

* Working Pressure is based on roll- or cut-grooved standard wall carbon steel pipe.

† Allowable Axial Displacement and Angular Movement (deflection) figures are for roll grooved standard steel pipe. Values for cut grooved pipe will be double that of roll grooved. These values are maximums; for design and installation purposes these figures should be reduced by: 50% for ¾" - 3½"; 25% for 4" and larger to compensate for jobsite conditions.

** Deflection or angular movement given is the maximum value that a coupling allows. When using the given maximum angles for a curved layout, proper bracing should be used to counter pressure thrust that will occur when the system is pressurized. Flexible couplings can be used for angular movement and or thermal expansion, though please note individual coupling(s) cannot be used to their maximums for both types of movement within a system at the same time.

Model G28 Hinged Lever Coupling

The Model G28 Hinged Lever Coupling is designed for quick connect and disconnect services. The housing segments are hinged with a locking lever handle for easy assembly. The use of the split pin can secure and prevent the accidental opening of the coupling.

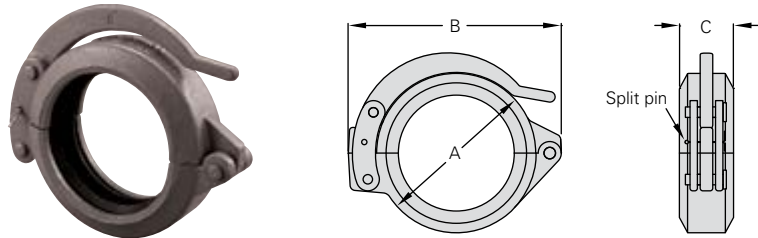

Nominal Size	Pipe O.D.	Max. Working Pressure (CWP)**	Max. End Load (CWP)	Axial Displacement †	Angular Movement / Deflection**†	Dimensions			Weight
						A	B	C	
in	in	PSI	Lbs	in	(°)	in	in	in	Lbs
mm	mm	Bar	kN	mm		mm	mm	mm	Kgs
1½	1.900	300	850	0 – 0.06	1° - 54'	2.95	4.65	1.85	2.2
40	48.3	20	3.66	0 – 1.6		75	118	47	1.0
2	2.375	300	1320	0 – 0.06	1° - 45'	3.43	5.08	1.85	2.4
50	60.3	20	5.71	0 – 1.6		87	129	47	1.1
2½	2.875	300	1940	0 – 0.06	1° - 15'	3.94	5.63	1.85	3.1
65	73.0	20	8.37	0 – 1.6		100	143	47	1.4
76.1 mm	3.000	300	2120	0 – 0.06	1° - 12'	4.06	5.67	1.85	3.1
	76.1	20	9.09	0 – 1.6		103	144	47	1.4
3	3.500	300	2880	0 – 0.06	1° - 12'	4.69	6.46	1.85	4.0
80	88.9	20	12.41	0 – 1.6		119	164	47	1.7
4	4.500	300	4760	0 – 0.13	1° - 36'	5.98	7.95	2.05	5.9
100	114.3	20	20.51	0 – 3.2		152	202	52	2.7
139.7 mm	5.500	300	7120	0 – 0.13	1° - 18'	6.97	9.80	2.05	10.8
	139.7	20	30.64	0 – 3.2		177	249	52	4.9
5	5.563	300	7280	0 – 0.13	1° - 18'	7.05	10.00	2.05	10.8
125	141.3	20	31.35	0 – 3.2		179	254	52	4.9
165.1 mm	6.500	300	9950	0 – 0.13	1° - 07'	7.80	10.87	2.05	13.2
	165.1	20	42.80	0 – 3.2		198	276	52	6.0
6	6.625	300	10330	0 – 0.13	1° - 05'	8.11	11.02	2.05	13.2
150	168.3	20	44.47	0 – 3.2		206	280	52	6.0
8	8.625	300	17510	0 – 0.13	0° - 50'	10.08	13.58	2.44	15.2
200	219.1	20	75.37	0 – 3.2		256	345	62	6.9
10	10.750	300	27210	0 – 0.13	0° - 40'	12.68	17.48	2.60	36.1
250	273.0	20	117.01	0 – 3.2		322	444	66	16.4

* Working pressure is based on roll grooved standard wall carbon steel pipe.

† Allowable Axial Displacement and Angular Movement (deflection) figures are for roll grooved standard steel pipe. Values for cut grooved pipe will be double that of roll grooved. These values are maximums; for design and installation purposes these figures should be reduced by: 50% for ¾" - 3½"; 25% for 4" and larger to compensate for jobsite conditions.

** Deflection or angular movement given is the maximum value that a coupling allows. When using the given maximum angles for a curved layout, proper bracing should be used to counter pressure thrust that will occur when the system is pressurized. Flexible couplings can be used for angular movement and or thermal expansion, though please note individual coupling(s) cannot be used to their maximums for both types of movement within a system at the same time.



Expansion Pipe

Lever handles are factory assembled tight for safety. The use of an expansion pipe will aid the easy opening and closing. Expansion pipes are available upon request.



Model C-7 Outlet Coupling

The Model C-7 Outlet Coupling combines the features of a coupling and a reducing outlet. The C-7 facilitates an easy reducing branch outlet without the need of a mechanical tee or reducing tee and couplings. The C-7 is available with grooved, male threaded or female threaded outlets. This fitting is recommended for fire sprinkler and other pipelines of moderate pressure. The C-7 Outlet Coupling can be used for dry pipe systems or vacuum services up to 10

inHg or 254 mmHg, which may occur when the system is drained.

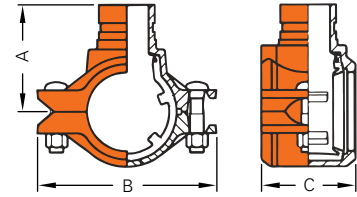

Grooved outlet

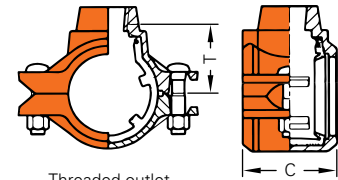

Threaded outlet

Run Pipe	Nominal Size		Max. Working Pressure (CWP)‡	Axial Displacement	Max. End Load (CWP)	Dimensions				Bolt Size	Weight
	FPT	Gr / MPT				T**	A	B	C		
in	in	in	PSI	in	Lbs	in	in	in	in	in	Lbs
mm	mm	mm	Bar	mm	kN	mm	mm	mm	mm	mm	Kgs
1½	½	—	500	0.81~0.88	1050	2.06	—	4.50	2.75	¾ x 2½	2.6
	15	—	35	20~22		52	—	114.3	70.0		1.2
	¾	—	500	0.81~0.88		2.06	—	4.50	2.75		2.6
	20	—	20	20~22		52	—	114.3	70.0		1.2
40	1	—	500	0.81~0.88	4.7	1.94	—	4.50	2.75	M10 x 55	2.9
	25	—	35	20~22		49	—	114.3	70.0		1.3
	½	—	500	0.81~0.88		2.32	—	5.00	2.75		3.1
	15	—	35	20~22		59	—	127.0	70.0		1.4
2	¾	—	500	0.81~0.88	2180	2.32	—	5.00	2.75	¾ x 2½	3.1
	20	—	35	20~22		59	—	127.0	70.0		1.4
	1	1	500	0.81~0.88		2.20	3.50	5.00	2.75		3.3
	25	33.4	35	20~22		56	89.0	127.0	70.0		1.5
50	½	—	500	1.25~1.50	3200	2.20	—	6.33	3.25	½ x 2¾	4.8
	15	—	35	32~38		56	—	161.0	83.0		2.2
	¾	—	500	1.25~1.50		2.56	—	6.33	3.25		4.6
	20	—	35	32~38		65	—	161.0	83.0		2.1
	1	—	500	1.25~1.50		2.44	—	6.33	3.25		4.4
	25	—	35	32~38		62	—	161.0	83.0		2.0
	1¼	1¼	500	1.25~1.50		2.36	3.70	6.33	3.25		5.1
	32	42.2	35	32~38		60	94.0	161.0	83.0		2.3
65	—	1½	500	1.25~1.50	14.2	—	3.70	6.33	3.25	M12 X 60	5.9
	—	48.3	35	32~38		—	94.0	161.0	83.0		2.4
	¾	—	500	1.25~1.50		2.83	—	6.87	3.25		5.9
	20	—	35	32~38		72	—	175.0	83.0		2.7
	1	1	500	1.25~1.50		2.75	4.00	6.87	3.25		6.2
	25	33.4	35	32~38		70	102.0	175.0	83.0		2.8
80	1½	1½	500	1.25~1.50	21.0	2.75	4.00	6.87	3.25	M12 X 75	6.4
	40	48.3	35	32~38		70	102.0	175.0	83.0		2.9
	¾	—	500	1.63~1.81		3.70	—	8.31	3.66		9.2
	20	—	35	41~46		94	—	211.0	93.0		4.2
	1	1	500	1.63~1.81		3.58	4.88	8.31	3.66		9.5
	25	33.4	35	41~46		91	124.0	211.0	93.0		4.3
100	1½	1½	500	1.63~1.81	34.9	3.31	4.88	8.31	3.66	¾ x 3½	9.5
	40	48.3	35	41~46		84	124.0	211.0	93.0		4.3
	2	2	500	1.63~1.81		3.50	4.88	8.31	3.66		9.9
	50	60.3	35	41~46		89	124.0	211.0	93.0		4.5
	¾	—	400	1.63~1.81		4.76	—	10.86	3.70		13.2
	20	—	28	41~46		121	—	276.0	94.0		6.0
6	1	—	400	1.63~1.81	14000	4.76	—	10.86	3.70	¾ x 3½	13.2
	25	—	28	41~46		121	—	276.0	94.0		6.0
	1½	1½	400	1.63~1.81		4.76	6.06	10.86	3.70		13.6
	40	48.3	28	41~46		121	154.0	276.0	94.0		6.2
	2	2	400	1.63~1.81		4.40	6.06	10.86	3.70		14.3
	50	60.3	28	41~46		111	154.0	276.0	94.0		6.5

FPT: Female threaded outlet

Gr: Grooved outlet

MPT: Male threaded outlet.

** T: Center of run pipe to end of outlet pipe (dimensions approximate). Female threaded outlet only.

‡ Working pressure is based on roll grooved standard wall carbon steel pipe.

Model 7706-T Transition Coupling

Model 7706-T Transition Couplings allows for a direct transition from IPS pipe sizes to ISO pipe sizes.

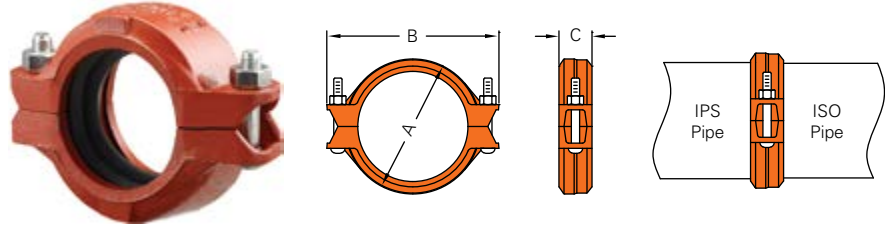

Nominal Size	Pipe O.D.	Max. Working Pressure (CWP)*	Max. End Load (CWP)	Axial Displacement †	Angular Movement**†		Dimensions			Bolt Size	Weight
					Degree Per Coupling	Per Pipe	A	B	C		
in	in	PSI	Lbs	in	1° - 12'	in / ft	in	in	in	in	Lbs
mm	mm	Bar	kN	mm		mm / m	mm	mm	mm	mm	Kgs
2½ x 76.1 mm	2.875 x 3.000	500	2110	0 ~ 0.065	0° - 33'	0.13	4.02	5.43	1.89	¾ x 2½	2.6
	73.0 x 76.1	35	9.09	0 ~ 1.6		11	102	138	48	M10 x 55	1.2
6 x 165.1 mm	6.625 x 6.500	400	9940	0 ~ 0.125	0° - 33'	0.12	7.87	10.63	2.09	¾ x 3½	7.7
	168.3 x 165.1	28	42.80	0 ~ 3.2		10	200	270	53	M16 x 90	3.5

* Working Pressure is based on roll grooved standard wall carbon steel pipe.

† Allowable Axial Displacement and Angular Movement (deflection) figures are for roll grooved standard steel pipe. Values for cut grooved pipe will be double that of roll grooved. These values are maximums; for design and installation purposes these figures should be reduced by: 50% for ¾" - 3½"; 25% for 4" and larger to compensate for jobsite conditions.

** Deflection or angular movement given is the maximum value that a coupling allows. When using the given maximum angles for a curved layout, proper bracing should be used to counter pressure thrust that will occur when the system is pressurized. Flexible couplings can be used for angular movement and or thermal expansion, though please note individual coupling(s) cannot be used to their maximums for both types of movement within a system at the same time.

Model 7771-T Transition Coupling

The Shurjoint Model 7771-T Transition Coupling allows for a direct transition from IPS pipe sizes to JIS pipe sizes. Available in nominal pipe sizes from 8" through 12" this coupling can accommodate a combination of pipes, valves and or fittings with a single coupling. Bolt pads are designed to make metal to metal contact to provide for a secure and rigid joint.



The stepped exterior design of the housings help to ensure the correct positioning of IPS and JIS sides.

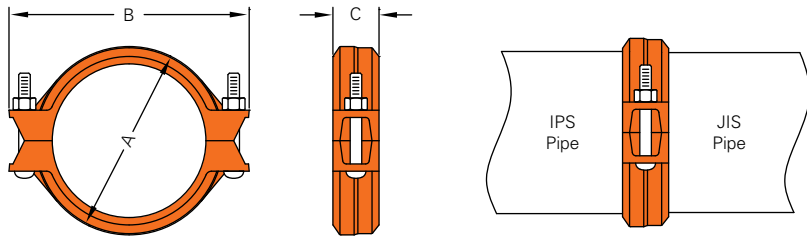

Nominal Size	Actual Pipe O.D.		Max. Working Pressure (CWP)*	Max. End Load (CWP)	Total Axial Displacement †	Dimensions			Bolt Size	Weight
	IPS	JIS				A	B	C		
in	in	in	PSI	Lbs	in	in	in	in	mm	Lbs
mm	mm	mm	Bar	kN	mm	mm	mm	mm	mm	Kgs
200 JIS	8.625	8.515	300	17520	0.13	10.20	13.19	2.50	M16 x 135	15.4
	219.1	216.3	20	75.37	3.2	259	335	63		7.0
250 JIS	10.750	10.528	300	27190	0.13	12.46	15.20	2.50	M20 x 120	19.8
	273.0	267.4	20	117.01	3.2	316	386	63		9.0
300 JIS	12.750	12.539	300	38280	0.13	14.45	17.64	2.50	M22 x 165	24.2
	323.9	318.5	20	164.71	3.2	367	448	63		11.0

For 6" (168.3) x 6" (165.1), see Model 7706-T.

* Working Pressure is based on roll- or cut-grooved standard wall carbon steel pipe.

† Allowable Axial Displacement and Angular Movement (deflection) figures are for roll grooved standard steel pipe. Values for cut grooved pipe will be double that of roll grooved. These values are maximums; for design and installation purposes these figures should be reduced by: 50% for ¾" - 3½"; 25% for 4" and larger to compensate for jobsite conditions.

Model XH-70EP Extra Heavy Rigid Coupling with End Protection (EP) Gasket

The Model XH-70EP is designed for use with plastic coated or cement lined pipe. The EP (end protection) gasket serves to form a continuous lined surface at the joint and also helps protect the pipe ends from

corrosion. This coupling is rated up to 2500 psi (175 Bar) when used in conjunction with machined EP cut grooves and the applicable pipe.



CAUTION: Always fasten the bolts to the required torque.

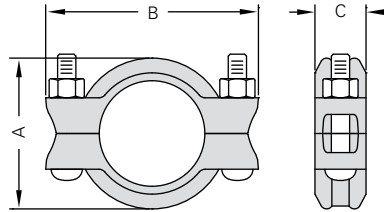
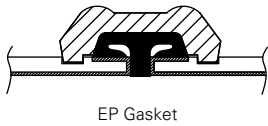

Nominal Size	Pipe O.D.	Max. Working Pressure (CWP)*	Max. End Load (CWP)	Dimensions			Bolt		Bolt Torque	Weight
				A	B	C	No.	Size		
in	in	PSI	Lbs	in	in	in		in	Lbs-Ft	Lbs
mm	mm	Bar	kN	mm	mm	mm			Nm	Kgs
2	2.375	2500	11070	3.54	5.71	1.92	2	5/8 x 2 1/4	60 - 90	3.3
50	60.3	175	50.0	90	145	49			80 - 120	1.5
2 1/2	2.875	2500	16220	4.06	6.61	1.92	2	5/8 x 2 1/4	60 - 90	4.0
65	73.0	175	73.2	103	168	49			80 - 120	1.8
3	3.500	2500	24040	4.80	7.40	2.00	2	5/8 x 2 1/4	60 - 90	4.8
80	88.9	175	108.6	122	188	51			80 - 120	2.2
4	4.500	2500	39740	6.18	8.74	2.17	2	3/4 x 4 1/4	74 - 170	8.8
100	114.3	175	179.5	157	222	55			100 - 235	4.0
6	6.625	2000	68910	8.58	11.61	2.25	2	7/8 x 5 1/2	125 - 200	17.6
150	168.3	140	311.3	218	295	57			170 - 275	8.0
8	8.625	1500	116790	10.83	14.33	2.75	2	1 x 5 1/2	200 - 300	24.0
200	219.1	105	527.6	275	364	70			275 - 400	10.9
10	10.750	1250	113400	13.15	16.70	2.95	2	1 x 5 1/2	200 - 300	31.2
250	273.0	88	514.8	334	424	75			275 - 400	14.2
12	12.750	1250	159510	15.35	18.90	2.95	2	1 x 5 1/2	200 - 300	36.7
300	323.9	88	724.7	390	480	75			275 - 400	16.7

* Pressures quoted are based on EP cut grooved XS (Sch. 80) pipe.

"EP" End Protection Cut Groove Specification for XH-70EP Coupling (IPS sizes)

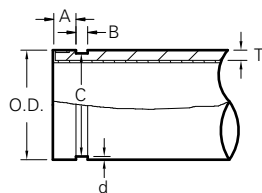

1. EP cut-grooves are for plastic coated or cement lined pipe to be connected with Shurjoint XH-70EP couplings only. Do not roll groove pipe, which can damage the coating or lining and or create flared pipe ends.
2. Always use plain-end square cut pipe. Do

- not use beveled end pipe.
3. Always use an EP gasket with a XH-70EP coupling. Do not use a standard gasket.
4. The gasket seating area shall be free from deep scores, marks, or ridges that could prevent a positive seal.

Nominal Size	Pipe O.D.			A		B		C		d	t	
	Basic	Tolerance		Gasket Seat		Groove Width		Groove Dia.				
		in	mm	in	mm	in	mm	in	mm	in	mm	
2	2.375	mm	+0.024	-0.024	0.562	±0.010	0.255	-0.005	2.250	-0.015	0.063	0.154
50	60.3	mm	+0.61	-0.61	14.27	±0.25	6.48	-0.13	57.15	-0.38	1.60	3.91
2 1/2	2.875	mm	+0.029	-0.029	0.562	±0.010	0.255	-0.005	2.720	-0.018	0.078	0.188
65	73.0	mm	+0.74	-0.74	14.27	±0.25	6.48	-0.13	69.09	-0.46	1.98	4.78
3	3.500	mm	+0.035	-0.031	0.562	±0.010	0.255	-0.005	3.344	-0.018	0.078	0.188
80	88.9	mm	+0.89	-0.79	14.27	±0.25	6.48	-0.13	84.94	-0.46	1.98	4.78
4	4.500	mm	+0.045	-0.031	0.605	±0.015	0.305	-0.005	4.334	-0.020	0.083	0.203
100	114.3	mm	+1.14	-0.79	15.37	±0.38	7.75	-0.13	110.08	-0.51	2.11	5.16
6	6.625	mm	+0.063	-0.031	0.605	±0.015	0.305	-0.005	6.455	-0.022	0.085	0.219
150	168.3	mm	+1.60	-0.79	15.37	±0.38	7.75	-0.13	163.96	-0.56	2.16	5.56
8	8.625	mm	+0.063	-0.031	0.714	±0.015	0.400	-0.010	8.441	-0.025	0.092	0.238
200	219.1	mm	+1.60	-0.79	18.14	±0.38	10.16	-0.25	214.40	-0.64	2.34	6.05
10	10.750	mm	+0.063	-0.031	0.714	±0.015	0.400	-0.010	10.562	-0.027	0.094	0.250
250	273.0	mm	+1.60	-0.79	18.14	±0.38	10.16	-0.25	268.28	-0.69	2.39	6.35
12	12.750	mm	+0.063	-0.031	0.714	±0.015	0.400	-0.010	12.531	-0.030	0.109	0.279
300	323.9	mm	+1.60	-0.79	18.14	±0.38	10.16	-0.25	318.29	-0.76	2.77	7.09

Flange Adapters

Shurjoint offers a variety of flange adapters 2" through 24" (50 mm – 600 mm) to transition from a flanged system to a grooved system. Flange drillings available include ANSI Class 125/150, Class 300, PN 10/16 and BS 10 Table E.

Flange adapters 2" through 12" are supplied hinged as a single assembly while 14" through 24" (7041N) are supplied with two independent segments and a draw kit.

Always use factory-supplied bolts and nuts to assemble flange segments. The use of other bolts may cause joint failure. If the factory supplied bolts cannot be used for the component that is being connected consult Shurjoint technical services for further guidance.

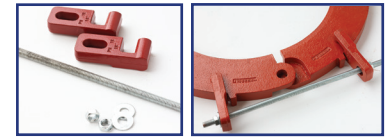
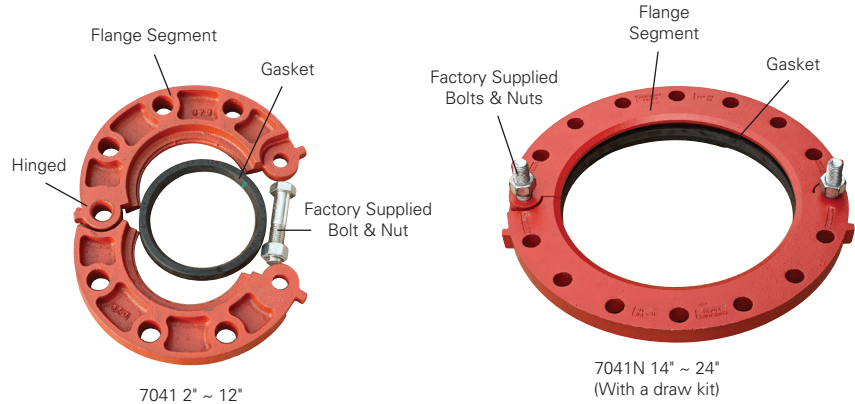

14" – 24": Supplied with a draw kit

Models 7041 / 7043 Flange Adapters



Important Notes

1. The Model 7041 flange adapter requires a hard flat face for effective sealing. Sealing surface D is the maximum inside face requirement, sealing surface E is the minimum outside face requirement. If the mating flange face is outside these dimensions, a flange gasket and model 49 sandwich plate (Model #49, see cut sheet #V-03) must be used. With the serrated faces of some valves or rubber-faced wafer valves, the mating surface might also be inadequate and a sandwich plate must be used.

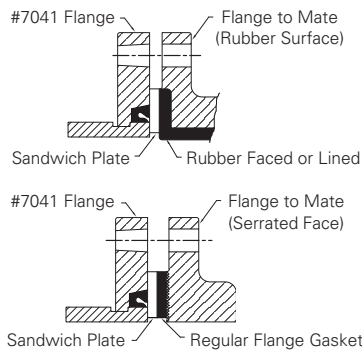

2. The Model 7041 flange adapter has small triangular teeth inside the key shoulder to prevent the pipe from rotating. These teeth should be removed when being connected to schedule 5 pipe, plastic pipe or components or surfaces that could be damaged by these teeth.

3. The Model 7041 flange adapter shall not be used as anchor points for tie-rods across non-restrained joints.

4. When assembling a Model 7041 flange adapter against a butterfly valve, make sure that the outside diameter of the flange adapters do not interfere with the valve actuator or the mounting pad of the actuator.

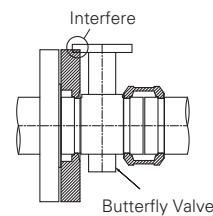

5. Bolt tightening sequence: Like a regular flange joint, it is important to make flange faces contact parallel. Tighten nuts alternately in the sequence of diagonally opposite pairs as shown below until the flange faces meet and make a metal-to-metal contact. When using two model 7041 flange adapters to mate pipe, or wafer / lug valves, the hinge point locations must be staggered 90° to each other, a model 49 sandwich plate must be used where appropriate, and flange adapter segment housings must remain parallel during nut tightening sequence.

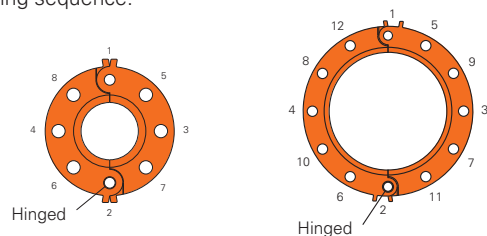

Model

7041 Flange Adapter - ANSI Class 125/150

The Shurjoint Model 7041 flange adapters 2" through 12" are supplied hinged as a single assembly, while 14" - 24" (7041N) are supplied with two independent segments and a draw kit.

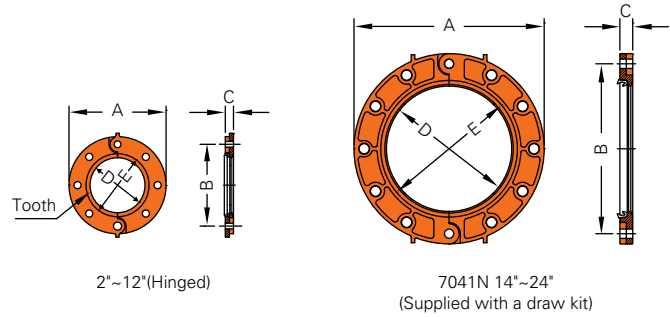

Nominal Size	Pipe O.D.	Max. Working Pressure (CWP)**	Max. End Load (CWP)	Dimensions			Sealing Surface		Bolt		Weight
				A	B	C	D	E	No.	Size	
in	in	PSI	Lbs	in	in	in	in	in		in	Lbs
mm	mm	Bar	kN	mm	mm	mm	mm	mm		mm	Kgs
2	2.375	300	1330	6.00	4.75	0.87	2.38	3.07	4	5/8	4.0
50	60.3	20	5.71	152	121	22	60	78			1.8
2½	2.875	300	1950	7.00	5.50	0.87	2.88	3.54	4	5/8	5.1
65	73.0	20	8.37	178	140	22	73	90			2.3
3	3.500	300	2880	7.52	6.00	0.94	3.50	4.17	4	5/8	6.2
80	88.9	20	12.41	191	152	24	89	106			2.8
4	4.500	300	4770	9.00	7.50	0.94	4.50	5.20	8	5/8	8.3
100	114.3	20	20.51	229	191	24	114	132			3.8
5	5.563	300	7290	10.00	8.50	1.00	5.56	6.26	8	3/4	10.3
125	141.3	20	31.35	254	216	25	141	159			4.7
6	6.625	300	10340	11.00	9.50	1.00	6.63	7.32	8	3/4	11.1
150	168.3	20	44.47	279	241	25	168	186			5.0
8	8.625	300	17520	13.50	11.75	1.14	8.63	9.29	8	3/4	17.2
200	219.1	20	75.37	343	298	29	219	236			7.8
10	10.750	300	27210	16.00	14.25	1.18	10.75	11.61	12	7/8	25.7
250	273.0	20	117.01	406	362	30	273	295			11.7
12	12.750	300	38280	19.02	17.00	1.25	12.75	13.62	12	7/8	37.6
300	323.9	20	164.71	483	432	32	324	346			17.1
14 (7041N)	14.000	300	46160	21.00	18.75	1.42	14.00	15.08	12	1	61.7
350	355.6	20	198.5	533	476	36	356	383			28.0
16 (7041N)	16.000	300	60290	23.50	21.25	1.42	16.00	16.97	16	1	77.1
400	406.4	20	259.3	597	540	36	406	431			35.0
18 (7041N)	18.000	300	76300	25.00	22.75	1.56	18.00	19.13	16	1½	86.0
450	457.2	20	328.2	635	578	40	457	486			39.0
20 (7041N)	20.000	300	94200	27.50	25.00	1.73	20.00	21.14	20	1½	109.1
500	508.0	20	405.2	699	635	44	508	537			49.5
24 (7041N)	24.000	300	135650	32.00	29.50	1.89	24.00	25.00	20	1¾	157.6
600	609.6	20	583.4	813	749	48	610	635			71.5

** Working Pressure is based on roll grooved standard wall carbon steel pipe.

Model

49 Sandwich Plate

The Model 7041 and 7043 flange adapters require a hard flat surface for effective gasket sealing. A sandwich plate is required and should always be used when the mating surface is not adequate as with the serrated faces of some valves or the rubber-faced or rubber-lined flange adapters of a wafer valve.

Material: Mild-steel, electro-zinc plated.
Stainless steel, type 304 or 316 is available on request.

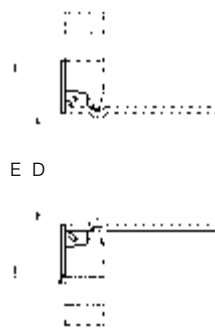

Sandwich plate

Nominal Size	E	D
in	in	in
mm	mm	mm
2	3.74	2.13
50	95	54
2½	4.65	2.64
65	118	67
3	5.12	3.19
80	130	81
4	6.22	4.13
100	158	105
5	7.40	5.00
125	188	128
6	8.50	6.10
150	216	155
8	10.67	8.07
200	271	205
10	12.83	10.15
250	326	258
12	15.00	12.00
300	381	305
14	17.40	13.46
350	442	342
16	19.92	15.43
400	506	392
18	21.26	17.44
450	540	443
20	23.50	19.45
500	597	494
24	27.87	23.46
600	708	596

Model

7041 Flange Adapter - PN 10 / PN 16

The Shurjoint Model 7041 flange adapter allows for a direct connection with PN 10/16 flanges. The two-segment design provides an easy and fast installation. 2" through 12" flange adapters are supplied hinged as a single assembly, while 14" - 24" (7041N) are supplied with two independent segments and a draw kit.

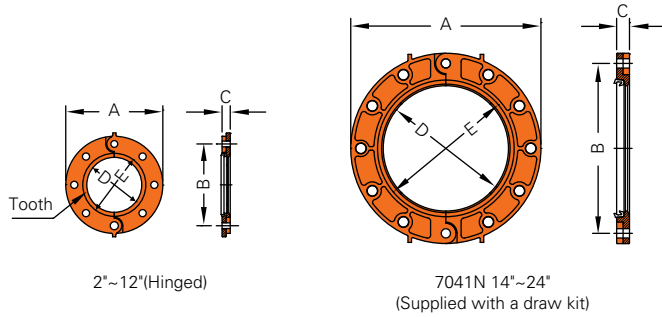

Nominal Size	Pipe O.D.	Max. Working Pressure (CWP)*	Max. End Load (CWP)	Dimensions			Sealing Surface		Bolt		Weight
				A	B	C	D	E	No.	Size	
in	in	PSI	Lbs	mm	mm	mm	mm	mm		mm	Lbs
mm	mm	Bar	kN								Kgs
2	2.375	300	1000	165	125	22	60	78	4	M16	5.1
50	60.3	20	4.6								2.3
76.1 mm	3.000	300	1590	185	145	22	76	92	4	M16	5.7
	76.1	20	7.3								2.6
3	3.500	300	2165	200	160	24	89	106	8	M16	7.1
80	88.9	20	9.9								3.2
4	4.500	300	3580	220	180	24	114	132	8	M16	7.5
100	114.3	20	16.4								3.4
139.7 mm	5.500	30	5340	250	210	25	140	159	8	M16	9.8
	139.7	20	24.5								4.4
165.1 mm	6.500	300	7460	285	240	24	165	182	8	M20	11.3
	165.1	20	34.2								5.1
6	6.625	300	7750	285	240	24	168	182	8	M20	10.1
150	168.3	20	35.6								4.6
8	8.625	300	13140	340	295	29	219	236	12	M20	17.2
200	219.1	20	60.3								7.8
10	10.750	300	20410	405	355	30	273	295	12	M24	25.2
250	273.0	20	93.6								11.4
12	12.750	300	28710	460	410	32	324	346	12	M24	30.2
300	323.9	20	131.8								13.7
14 (7041N)	14.000	300	46160	520	470	36	356	383	16	M24	48.7
350	355.6	20	198.5								22.1
16 (7041N)	16.000	300	60290	580	525	38	406	431	16	M27	59.7
400	406.4	20	259.3								27.1
18 (7041N)	18.000	300	76300	640	585	40	457	486	20	M27	71.6
450	457.2	20	328.2								32.5
20 (7041N)	20.000	300	94200	715	650	43	508	537	20	M30	103.4
500	508.0	20	405.2								47.0
24 (7041N)	24.000	300	135650	840	770	48	610	635	20	M33	160.6
600	609.6	20	583.4								73.0

Note: 2" - 6" flange drilling to PN10 / PN16 and 8" and above to PN16. See below for required bolt torque.

* Working Pressure is based on roll grooved standard wall carbon steel pipe.



Required bolt torque

The tables show standard torque values for proper assembly of Shurjoint

flange adapters. Use a torque wrench so that all the nuts are tightened equally with the same torque value. Shurjoint flange

adapters are sealed with elastic (rubber) gaskets, which require much lower torques than those that utilize metallic gaskets.

Required Torque for Model 7041 Flange Adapters (ANSI Class 125 / 150, BS 10-E)

Nominal Size inch	Bolt		Required Torque	
	Size inch	No.	Lbs-Ft	Nm
2	5/8	4	110 ~ 140	149 ~ 190
2½	5/8	4	110 ~ 140	149 ~ 190
3	5/8	4	110 ~ 140	149 ~ 190
4	5/8	8	110 ~ 140	149 ~ 190
5	3/4	8	220 ~ 250	298 ~ 339
6	3/4	8	220 ~ 250	298 ~ 339
8	3/4	8	220 ~ 250	298 ~ 339
10	7/8	12	320 ~ 400	434 ~ 542
12	7/8	12	320 ~ 400	434 ~ 542
14	1	12	360 ~ 520	488 ~ 705
16	1	16	360 ~ 520	488 ~ 705
18	1½	16	450 ~ 725	610 ~ 982
20	1½	20	450 ~ 725	610 ~ 982
24	1¾	20	620 ~ 1000	841 ~ 1356

Required Torque for Model 7041 Flange Adapters (PN 10/16)

Nominal Size inch	Bolt		Required Torque	
	Size inch	No.	Lbs-Ft	Nm
50	M16	4	110 ~ 140	149 ~ 190
65	M16	4	110 ~ 140	149 ~ 190
80	M16	8	110 ~ 140	149 ~ 190
100	M16	8	110 ~ 140	149 ~ 190
125	M20	8	220 ~ 250	298 ~ 339
150	M20	8	220 ~ 250	298 ~ 339
200	M20	12	220 ~ 250	298 ~ 339
250	M24	12	320 ~ 400	434 ~ 542
300	M24	12	320 ~ 400	434 ~ 542
350	M24	16	320 ~ 400	434 ~ 542
400	M27	16	360 ~ 520	488 ~ 705
450	M27	20	360 ~ 520	488 ~ 705
500	M30	20	450 ~ 725	610 ~ 982
600	M33	20	620 ~ 1000	841 ~ 1356

Required Torque for Model 7043 Flange Adapters (ANSI Class 300)

Nominal Size inch	Bolt		Required Torque	
	Size inch	No.	Lbs-Ft	Nm
2	5/8	8	110 ~ 140	149 ~ 190
2½	5/8	8	220 ~ 250	298 ~ 339
3	3/4	8	220 ~ 250	298 ~ 339
4	3/4	8	220 ~ 250	298 ~ 339
5	3/4	8	220 ~ 250	298 ~ 339
6	3/4	12	220 ~ 250	298 ~ 339
8	7/8	12	320 ~ 400	434 ~ 542
10	1	16	360 ~ 520	488 ~ 705
12	1½	16	450 ~ 725	610 ~ 982

Model 7041 Flange Adapter - BS 10-E

The Shurjoint Model 7041 flange adapter allows for a direct connection with BS 10 Table E flanges. The two-segment design provides an easy and fast installation.

2" through 12" flange adapters are supplied hinged as a single assembly, while 14" - 24" (7041N) are supplied with two independent segments and a draw kit.

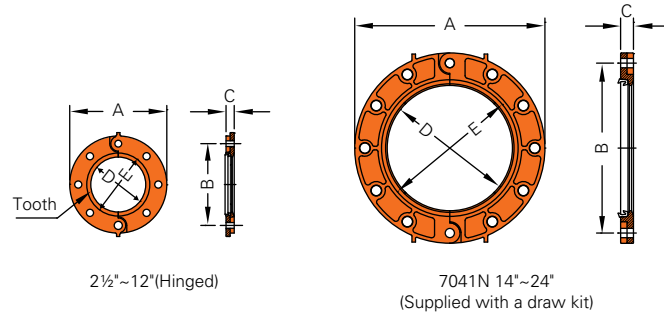

Nominal Size	Pipe O.D.	Max. Working Pressure (CWP)**	Max. End Load (CWP)	Dimensions			Sealing Surface		Bolt		Weight
				A	B	C	D	E	No.	Size	
mm	mm	Bar	kN	mm	mm	mm	mm	mm		in	Kgs
76.1 mm	76.1	20	6.36	165	127	22	76	92	4	5/8	2.5
80	88.9	20	8.69	184	146	24	89	106	4	5/8	2.8
100	114.3	20	14.36	216	178	24	114	132	8	5/8	3.4
139.7 mm	139.7	20	21.45	254	210	24	140	170	8	5/8	4.5
165.1 mm	165.1	20	29.96	279	235	24	165	182	8	3/4	5.0
200	219.1	20	52.76	343	292	29	219	236	8	3/4	8.4
250	273.0	20	81.91	405	356	30	273	295	12	3/4	10.8
350 (7041N)	355.6	20	198.53	527	470	32	356	383	12	7/8	20.8
400 (7041N)	406.4	20	259.30	578	521	32	406	431	12	7/8	21.0
450 (7041N)	457.2	20	328.18	641	584	36	457	486	16	7/8	28.9
500 (7041N)	508.0	20	405.16	705	641	38	508	537	16	7/8	38.1
600 (7041N)	609.6	20	583.43	826	756	42	610	635	16	1 1/8	54.6

See page 34 for required bolt torque.

** Working Pressure is based on roll grooved standard wall carbon steel pipe.

Model 7043 Flange Adapter - ANSI Class 300

The Shurjoint Model 7043 flange adapter allows for direct connection of a grooved system to ANSI Class 300 flanged components. 2" through 8" Model 7043 flange adapters are supplied hinged as a single assembly, while large sizes are supplied with separate segments.

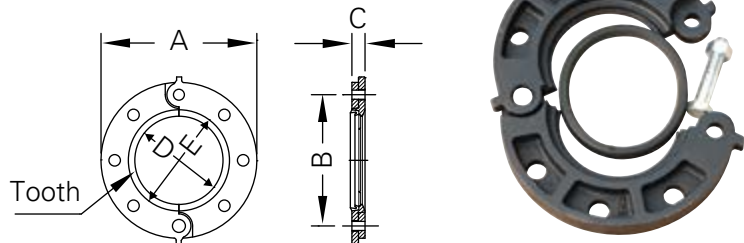

Nominal Size	Pipe O.D.	Max. Working Pressure (CWP)*	Max. End Load (CWP)	Dimensions			Sealing Surface		Bolt		Weight
				A	B	C	D	E	No.	Size	
in	in	PSI	Lbs	in	in	in	in	in		in	Lbs
mm	mm	Bar	kN	mm	mm	mm	mm	mm		in	Kgs
2	2.375	750	3320	6.50	5.00	0.94	2.38	3.07	8	5/8	5.3
50	60.3	52	14.84	165	127	24	60	78	8	5/8	2.4
2 1/2	2.875	750	4860	7.50	5.88	1.06	2.88	3.54	8	3/4	7.9
65	73.0	52	21.75	191	149	27	73	90	8	3/4	3.6
3	3.500	750	7210	8.25	6.63	1.19	3.50	4.17	8	3/4	10.0
80	88.9	52	32.26	210	168	30	89	106	8	3/4	4.6
4	4.500	750	11920	10.00	7.95	1.31	4.50	5.20	8	3/4	17.3
100	114.3	52	53.33	254	202	33	114	132	8	3/4	7.8
5	5.563	750	18220	11.00	9.25	1.44	5.56	5.55	8	3/4	21.3
125	141.3	52	81.50	279	235	37	141	141	8	3/4	9.7
6	6.625	750	25840	12.50	10.63	1.50	6.63	7.32	12	3/4	26.9
150	168.3	52	115.62	318	270	38	168	186	12	3/4	12.2
8	8.625	750	43790	15.00	13.00	1.61	8.63	9.29	12	7/8	36.2
200	219.1	52	195.96	381	330	41	219	236	12	7/8	16.4
10	10.750	750	68030	17.68	15.25	1.89	10.75	11.61	16	1	56.9
250	273.0	52	304.23	449	387	48	273	295	16	1	25.8
12	12.750	750	95700	20.50	17.75	1.93	12.75	13.62	16	1 1/8	77.7
300	323.9	52	428.25	521	451	49	324	346	16	1 1/8	35.2

See page 34 for required bolt torque.

* Working Pressure is based on roll grooved standard wall carbon steel pipe.

Model

7170 Flange Adapter - ANSI Class 125/150

The Model 7170 Flange Adapter provides a rigid transition between ANSI class 125/150 flanged components and a grooved system.

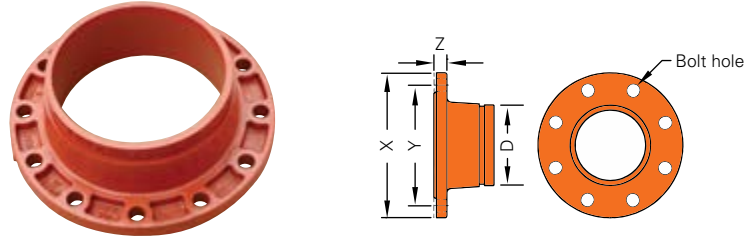

Nominal Size	X	Y	Z	Bolt Size	Bolt Hole		D	L	Weight
					Dia.	No.			
in	in	in	in	in	in		in	in	Lbs
mm	mm	mm	mm	in	in		mm	mm	Kgs
10	15.98	14.25	1.18	¾	1	12	10.75	5.00	48.4
250	406.0	362.0	30.0	¾	1	12	273.0	127.0	22.0
12	19.00	17.00	1.25	¾	1	12	12.75	5.00	61.6
300	483.0	432.0	32.0	¾	1	12	323.9	127.0	28.0
14	21.00	18.75	1.38	1	1½	12	14.00	5.00	108.9
350	533.0	476.3	35.0	1	1½	12	355.6	127.0	49.5
16	23.50	21.25	1.46	1	1½	16	16.00	5.00	110.0
400	597.0	539.7	37.0	1	1½	16	406.4	127.0	50.0
18	25.00	22.75	1.57	1½	1¼	16	18.00	5.50	137.5
450	635.0	577.8	40.0	1½	1¼	16	457.2	140.0	62.5
20	27.50	25.00	1.69	1½	1¼	20	20.00	5.71	158.4
500	699.0	635.0	43.0	1½	1¼	20	508.0	145.0	72.0
24	32.00	29.50	1.89	1½	1¾	20	24.00	6.00	218.9
600	813.6	749.3	48.0	1½	1¾	20	609.6	152.0	99.5

Model 7180 Universal Flange Adapter

The Model 7180 Universal Flange Adapter provides a rigid transition from a flanged component to a grooved system. The single unit is compatible for a range of flange types including ANSI Class 125/150, PN10, PN16, and JIS 10K.

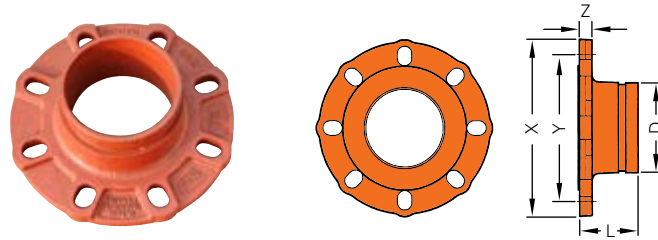

Nominal Size	Pipe O.D.	L	X	Y : Flange Drilling				Z	Bolt Size		Weight
				ANSI 125 / 150	PN 10 / 16	JIS 10K	BS 10E		Dia	No.	
in	in	in	in	in	in	in	in	in	in		Lbs
mm	mm	mm	mm	mm	mm	mm	mm	mm	mm		Kgs
2	2.375	2.50	6.50	4.75	4.92	4.72	4.49	0.63	5/8	4	5.10
50	60.3	64	165	121	125	120	114	16	M16	4	2.30
2½	2.875	2.99	7.28	5.50	5.70	5.50	5.00	0.63	5/8	4	6.53
65	73.0	76	185	140	145	140	127	16	M16	4	2.96
76.1 mm	3.000	2.99	7.28	5.50	5.70	5.50	5.00	0.63	5/8	4	6.40
	76.1	76	185	140	145	140	127	16	M16	4	2.90
3	3.500	2.95	7.87	6.00	6.30	5.90	5.75	0.63	5/8	4 / 8	7.47
80	88.9	75	200	152	160	150	146	16	M16	4 / 8	3.39
4	4.500	2.95	8.86	7.50	7.09	6.89	7.00	0.63	5/8	8	8.49
100	114.3	75	225	191	180	175	178	16	M16	8	3.85
139.7 mm	5.500	2.95	10.00	8.50	8.27	8.27	8.27	0.63	5/8	8	14.33
	139.7	75	254	216	210	210	210	16	M16 / M20	8	6.50
5	5.563	2.95	10.00	8.50	8.27	8.27	—	0.87	5/8	8	14.33
125	141.3	75	254	216	210	210	—	22	M16 / M20	8	6.50
165.1 mm	6.500	2.95	10.71	9.50	9.45	9.45	9.30	0.63	3/4	8	13.86
	165.1	75	272	241	240	240	235	16	M20	8	6.30
6	6.625	2.95	10.71	9.50	9.45	9.45	—	0.63	3/4	8	12.58
150	168.3	75	272	241	240	240	—	16	M20	8	5.72
8	8.625	4.00	13.50	11.75	11.61	11.42	11.50	0.87	3/4	8 / 12	30.09
200	219.1	102	343	298	295	290	292	22	M20	8 / 12	13.65
200 JIS	8.516	4.00	13.50	11.75	11.61	11.42	—	0.87	3/4	8 / 12	30.09
	216.3	102	343	298	295	290	—	22	M20	8 / 12	13.65

Model 7181 Universal Reducing Flange Adapter

The Model 7181 Universal Reducing Flange Adapter provides a rigid transition between a flanged piping system and a one or two-size reduced grooved system without the need of a concentric reducer. The flange drilling is compatible to ANSI 125/150, PN10/16, BS-10E and JIS 10K.

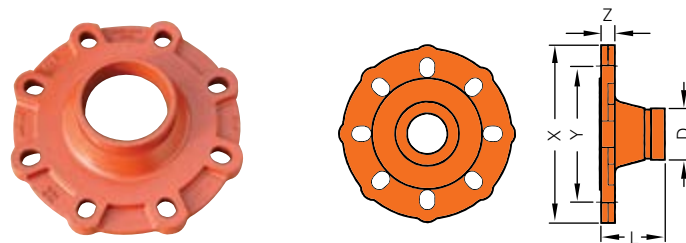

Nominal Size	Pipe O.D.	L	X	Z	Y : Flange Drilling			D	Bolt		Weight
					ANSI 125 / 150	PN 10 / 16	JIS 10K		Dia.	No.	
in	in	in	in	in	in	in	in	in	in		Lbs
mm	mm	mm	mm	mm	mm	mm	mm	mm	mm		Kgs
3 x 2	3.500 x 2.375	2.95	8.19	0.63	8.00	6.30	5.90	2.000	5/8	8	5.95
80 x 50	88.9 x 60.3	75.0	208.0	16.0	152	160	150	60.3	M16	8	2.70
4 x 2½	4.500 x 2.875	3.00	8.88	0.63	7.52	7.09	6.89	2.875	5/8	8	8.80
100 x 65	114.3 x 73.0	76.0	225.5	16.0	191	180	175	73.0	M16	8	4.00
100 x 76.1 mm	4.500 x 3.000	3.00	8.88	0.63	7.52	7.09	6.89	3.000	5/8	8	8.80
	114.3 x 76.1	76.0	225.5	16.0	191	180	175	76.1	M16	8	4.00
4 x 3	4.500 x 3.500	2.95	8.88	0.63	7.50	7.09	6.89	3.000	5/8	8	7.61
100 x 80	114.3 x 88.9	75.0	225.5	16.0	191	180	175	88.9	M16	8	3.45
6 x 4	6.625 x 4.500	2.95	11.46	0.95	9.50	9.45	9.45	4.000	3/4	8	15.61
150 x 100	168.3 x 114.3	75.0	291.0	24.0	241	240	240	114.3	M20	8	7.08

Mechanical Tees

Shurjoint mechanical tees provide a fast and easy mid-point branch outlet, eliminating the need for welding or the use of multiple fittings.

The Model M21 features a female threaded outlet and M22 features a grooved end outlet. Model 7721 (female threaded outlet) and 7722 (grooved end outlet) are available in 8" sizes. The Model 723 Saddle-let features a compact-design for making direct connections to sprinkler heads, drop nipples and or gauges.

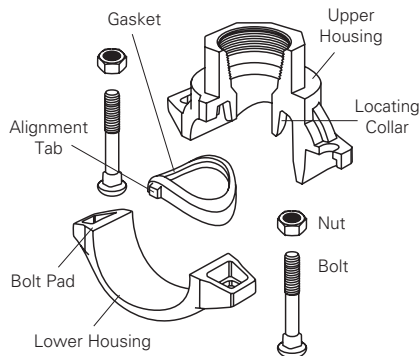
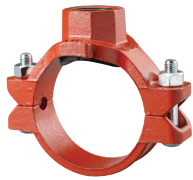

When bolts are tightened with a proper torque, the outlet housing makes metal to metal contact with the outer surface of the pipe.

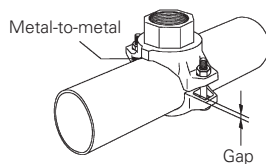

It is normal to see bolt pad gaps, though they should be equal on both sides of the mechanical tee.



The hole must be cleanly cut using the correct size hole-saw and shall have a smooth edge. Never use a torch for cutting a hole.

Hole-cutting

The hole-cut method of pipe preparation is required when using mechanical tees, mechanical crosses, and saddle-lets. The method of pipe preparation requires the cutting or drilling of a specified hole size on the centerline of the pipe.

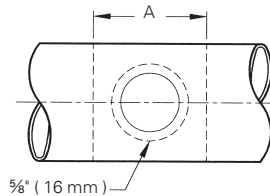

Always use the correct hole saw size as shown in each data chart and never use a torch for cutting a hole. After the hole has been cut all rough edges must be removed and the area within $\frac{5}{8}$ " (16 mm) of the hole should be inspected to ensure a clean smooth surface, free of any indentations or projections that could affect proper gasket sealing. The area within the "A" dimension should also be inspected and must be free of dirt, scale or any imperfection that could affect proper seating or assembly of the fitting.

Hole Size: The hole sizes are dictated by the branch size of the mechanical tee. Refer to product data chart.



Ridgid Model No. HC-300
Hole Cutting Tool

Model

7721 Mechanical Tee Female Threaded Outlet

The Model 7721 & M21 Mechanical Tees provide a fast and easy mid-pipe threaded branch outlet. The 7721 & M21 eliminate the need for welding or multiple fittings. The mechanical tee utilizes ductile iron housings, a grade E moulded gasket and heat-treated carbon steel track bolts and nuts. UL/FM working pressure of Model 7721 rated to 300 psi (20 Bar).

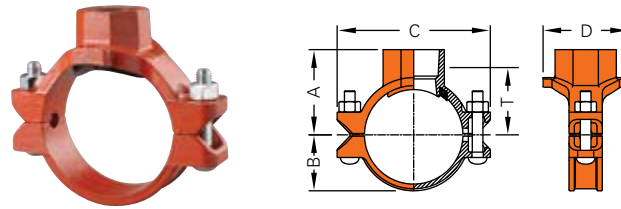

Nominal Size Run x Branch	Max. Working Pressure (CWP)*	Hole Dia. ƒ +3.2, -0 / +0.13, -0	Dimensions					Bolt Size	Weight
			T±	A	B	C	D		
in	PSI	in	in	in	in	in	in	in	Lbs
mm	Bar	mm	mm	mm	mm	mm	mm	mm	Kgs
2 x ½	300	1.50	1.97	2.50	1.57	5.04	2.87	¾ x 2½	2.4
50 x 15	20	38	50	64	40	128	73	M10 x 55	1.1
2 x ¾	300	1.50	1.97	2.50	1.57	5.04	2.87	¾ x 2½	2.4
50 x 20	20	38	50	64	40	128	73	M10 x 55	1.1
2 x 1	300	1.50	2.00	2.68	1.57	5.04	2.87	¾ x 2½	2.6
50 x 25	20	38	51	68	40	128	73	M10 x 55	1.2
2 x 1¼	300	1.75	2.08	2.80	1.57	5.04	3.22	¾ x 2½	2.9
50 x 32	20	45	53	71	40	128	82	M10 x 55	1.3
2 x 1½	300	1.75	2.08	2.80	1.57	5.04	3.22	¾ x 2½	2.9
50 x 40	20	45	53	71	40	128	82	M10 x 55	1.3
2½ x ½	300	1.50	2.25	2.80	1.89	5.75	2.87	½ x 3	3.1
65 x 15	20	38	57	71	48	146	73	M12 x 75	1.4
2½ x ¾	300	1.50	2.32	2.88	1.89	5.75	2.87	½ x 3	3.1
65 x 20	20	38	59	73	48	146	73	M12 x 75	1.4
2½ x 1	300	1.50	2.28	2.95	1.89	5.75	2.87	½ x 3	3.3
65 x 25	20	38	58	75	48	146	73	M12 x 75	1.5
2½ x 1¼	300	2.00	2.40	3.11	1.89	5.75	3.22	½ x 3	3.5
65 x 32	20	51	61	79	48	146	82	M12 x 75	1.6
2½ x 1½	300	2.00	2.40	3.11	1.89	5.75	3.22	½ x 3	3.5
65 x 40	20	51	61	79	48	146	82	M12 x 75	1.6
3 x ½	300	1.50	2.47	3.19	2.20	6.39	2.63	½ x 3	3.5
80 x 15	20	38	63	81	56	160	67	M12 x 75	1.6
3 x ¾	300	1.50	2.44	3.07	2.09	6.30	2.76	½ x 3	3.5
80 x 20	20	38	62	78	53	160	70	M12 x 75	1.6
3 x 1	300	1.50	2.50	3.19	2.20	6.39	2.63	½ x 3	3.7
80 x 25	20	38	64	81	56	160	67	M12 x 75	1.7
3 x 1¼	300	2.00	2.80	3.50	2.20	6.39	3.46	½ x 3	4.2
80 x 32	20	51	71	89	56	160	88	M12 x 75	1.9
3 x 1½	300	2.00	2.80	3.50	2.20	6.39	3.46	½ x 3	4.4
80 x 40	20	51	71	89	56	160	88	M12 x 75	2.0
3 x 2	300	2.50	2.83	3.58	2.20	6.39	3.98	½ x 3	5.1
80 x 50	20	64	72	91	56	160	101	M12 x 75	2.3
4 x ½	300	1.50	3.00	3.70	2.83	7.48	2.63	½ x 3	4.2
100 x 15	20	38	76	94	72	190	67	M12 x 75	1.9
4 x ¾	300	1.50	2.95	3.58	2.68	7.48	2.91	½ x 3	4.2
100 x 20	20	38	75	91	68	190	74	M12 x 75	1.9
4 x 1	300	1.50	3.03	3.70	2.83	7.48	2.63	½ x 3	4.4
100 x 25	20	38	77	94	72	190	67	M12 x 75	2.0
4 x 1¼	300	2.00	3.19	3.89	2.83	7.48	3.35	½ x 3	4.8
100 x 32	20	51	81	99	72	190	85	M12 x 75	2.2
4 x 1½	300	2.00	3.19	3.89	2.83	7.48	3.35	½ x 3	5.1
100 x 40	20	51	81	99	72	190	85	M12 x 75	2.3
4 x 2	300	2.50	3.38	4.13	2.83	7.48	3.98	½ x 3	5.9
100 x 50	20	64	86	105	72	190	101	M12 x 75	2.7
4 x 2½	300	2.75	3.23	4.37	2.83	7.48	4.40	½ x 3	7.3
100 x 65	20	70	82	111	72	190	112	M12 x 75	3.3
4 x 3	300	3.50	3.23	4.40	2.83	7.48	5.35	¾ x 3½	12.3
100 x 80	20	89	82	112	72	190	136	M16 x 90	5.6
5 x 2	300	2.50	4.13	4.88	3.39	9.29	4.00	¾ x 3½	9.2
125 x 50	20	64	105	124	86	236	102	M16 x 90	4.2
5 x 2½	300	2.75	3.89	5.00	3.39	9.29	4.65	¾ x 3½	9.9
125 x 65	20	70	99	127	86	236	118	M16 x 90	4.5

Continued on next page.

Continued from previous page.

Nominal Size Run x Branch	Max. Working Pressure (CWP)*	Hole Dia. ∇ +3.2, -0 / +0.13, -0	Dimensions					Bolt Size	Weight
			T \ddagger	A	B	C	D		
in	PSI	in	in	in	in	in	in	in	Lbs
mm	Bar	mm	mm	mm	mm	mm	mm	mm	Kgs
6 x 1/2	300	2.00	4.48	4.96	3.78	10.24	3.54	5/8 x 5 ⁵ / ₁₆	9.7
150 x 15	20	51	114	126	96	260	90	M16 x 135	4.4
6 x 1	300	2.00	4.33	5.00	3.86	10.07	3.50	5/8 x 5 ⁵ / ₁₆	9.7
150 x 25	20	51	110	127	98	256	89	M16 x 135	4.4
6 x 1 1/4	300	2.00	4.29	5.00	3.86	10.07	3.66	5/8 x 5 ⁵ / ₁₆	9.7
150 x 32	20	51	109	127	98	256	93	M16 x 135	4.4
6 x 1 1/2	300	2.00	4.29	5.00	3.86	10.07	3.66	5/8 x 5 ⁵ / ₁₆	9.7
150 x 40	20	51	109	127	98	256	93	M16 x 135	4.4
6 x 2	300	2.50	4.45	5.29	3.86	10.07	3.98	5/8 x 5 ⁵ / ₁₆	10.6
150 x 50	20	64	113	132	98	256	101	M16 x 135	4.8
6 x 2 1/2	300	2.75	4.37	5.50	3.86	10.07	4.65	5/8 x 5 ⁵ / ₁₆	11.9
150 x 65	20	70	111	140	98	256	118	M16 x 135	5.4
6 x 3	300	3.50	4.33	5.50	3.86	10.07	5.39	5/8 x 5 ⁵ / ₁₆	13.2
150 x 80	20	89	110	140	98	256	137	M16 x 135	6.0
6 x 4	300	4.50	4.21	5.50	3.86	10.07	6.46	5/8 x 5 ⁵ / ₁₆	14.5
150 x 100	20	114	107	140	98	256	164	M16 x 135	6.6
8 x 1/2	300	2.75	5.31	5.82	4.72	12.87	4.40	3/4 x 4 3/4	12.5
200 x 15	20	70	135	148	120	327	112	M20 x 120	5.7
8 x 1	300	2.75	5.31	5.98	4.72	12.87	4.40	3/4 x 4 3/4	12.5
200 x 25	20	70	135	152	120	327	112	M20 x 120	5.7
8 x 1 1/4	300	2.75	5.31	5.98	4.72	12.87	3.98	3/4 x 4 3/4	12.5
200 x 32	20	70	135	152	120	327	101	M20 x 120	5.7
8 x 1 1/2	300	2.75	5.31	5.98	4.72	12.87	3.98	3/4 x 4 3/4	12.5
200 x 40	20	70	135	152	120	327	101	M20 x 120	5.7
8 x 2	300	2.75	5.31	6.54	4.72	12.87	3.98	3/4 x 4 3/4	13.6
200 x 50	20	70	135	166	120	327	101	M20 x 120	6.2
8 x 2 1/2	300	2.75	5.39	6.54	4.72	12.87	4.09	3/4 x 4 3/4	13.9
200 x 65	20	70	137	166	120	327	104	M20 x 120	6.3
8 x 3	300	3.50	5.35	6.54	4.72	12.87	5.04	3/4 x 4 3/4	15.6
200 x 80	20	89	136	166	120	327	128	M20 x 120	7.1
8 x 4	300	4.50	5.24	6.54	4.72	12.87	6.46	3/4 x 4 3/4	17.6
200 x 100	20	114	133	166	120	327	164	M20 x 120	8.0

∇ Hole diameters listed are suggested hole diameters.

\ddagger T: Take-Out (Center of run to end of pipe to be engaged.)

* Working pressure is based on standard wall carbon steel pipe.

Model

M21 Mechanical Tee Female Threaded Outlet

Threads are NPT per ANSI B1.20.1 or BSPT per ISO 7. UL/FM working pressure is 300 psi (20 Bar).

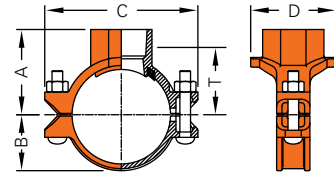

Nominal Size Run x Branch	Pipe O.D.	Max. Working Pressure (CWP)**	Hole Dia. \mp +3.2, -0 / +0.13, -0	Dimensions					Bolt Size	Weight
				T \mp	A	B	C	D		
in mm	in mm	PSI Bar	in mm	in mm	in mm	in mm	in mm	in mm	in mm	Lbs Kgs
2 x 1/2	2.375 x 0.840	300	1.50	1.97	2.50	1.50	4.56	3.19	3/8 x 2 1/8	2.18
50 x 15	60.3 x 21.3	20	38	50	63.5	38.1	115.9	81	M10 x 55	0.99
2 x 3/4	2.375 x 1.050	300	1.50	1.97	2.50	1.50	4.56	3.19	3/8 x 2 1/8	2.22
50 x 20	60.3 x 26.7	20	38	50	63.5	38.1	115.9	81	M10 x 55	1.01
2 x 1	2.375 x 1.315	300	1.50	1.85	2.50	1.50	4.56	3.19	3/8 x 2 1/8	2.40
50 x 25	60.3 x 33.4	20	38	47	63.5	38.1	115.9	81	M10 x 55	1.09
2 x 1 1/4	2.375 x 1.660	300	[1.75]	2.05	2.87	1.50	4.56	3.31	3/8 x 2 1/2	2.77
50 x 32	60.3 x 42.2	20	[45]	52	73.0	38.1	115.9	84	M10 x 55	1.26
2 x 1 1/2	2.375 x 1.900	300	[1.75]	2.08	3.00	1.50	4.56	3.31	3/8 x 2 1/2	3.01
50 x 40	60.3 x 48.3	20	[45]	52	76.2	38.1	115.9	84	M10 x 55	1.37
2 1/2 x 1/2	2.875 x 0.840	300	1.50	2.20	2.75	1.75	5.56	3.19	1/2 x 2 3/8	2.60
65 x 15	73.0 x 21.3	20	38	56	69.9	44.5	141.3	81	M12 x 60	1.20
2 1/2 x 3/4	2.875 x 1.050	300	1.50	2.20	2.75	1.75	5.56	3.19	1/2 x 2 3/8	2.70
65 x 20	73.0 x 26.7	20	38	56	69.9	44.5	141.3	81	M12 x 60	1.20
2 1/2 x 1	2.875 x 1.315	300	1.50	2.09	2.75	1.75	5.56	3.19	1/2 x 2 3/8	2.86
65 x 25	73.0 x 33.4	20	38	53	69.9	44.5	141.3	81	M12 x 60	1.30
2 1/2 x 1 1/4	2.875 x 1.660	300	2.00	2.28	3.00	1.75	5.56	3.70	1/2 x 2 3/8	3.21
65 x 32	73.0 x 42.2	20	51	58	76.2	44.5	141.3	94	M12 x 60	1.46
2 1/2 x 1 1/2	2.875 x 1.900	300	2.00	2.28	3.00	1.75	5.56	3.70	1/2 x 2 3/8	3.43
65 x 40	73.0 x 48.3	20	51	58	76.2	44.5	141.3	94	M12 x 60	1.56
76.1 mm x 15	3.000 x 0.840	300	1.50	2.20	2.75	1.81	5.69	3.19	1/2 x 2 3/8	2.64
	76.1 x 21.3	20	38	56	69.9	46.1	144.5	81	M12 x 60	1.20
76.1 mm x 20	3.000 x 1.050	300	1.50	2.20	2.75	1.81	5.69	3.19	1/2 x 2 3/8	2.64
	76.1 x 26.7	20	38	56	69.9	46.1	144.5	81	M12 x 60	1.20
76.1 mm x 25	3.000 x 1.315	300	1.50	2.09	2.75	1.81	5.69	3.19	1/2 x 2 3/8	2.86
	76.1 x 33.4	20	38	53	69.9	46.1	144.5	81	M12 x 60	1.30
76.1 mm x 32	3.000 x 1.660	300	2.00	2.28	3.00	1.81	5.69	3.70	1/2 x 2 3/8	3.21
	76.1 x 42.2	20	51	58	76.2	46.1	144.5	94	M12 x 60	1.46
76.1 mm x 40	3.000 x 1.900	300	2.00	2.28	3.00	1.81	5.69	3.70	1/2 x 2 3/8	3.43
	76.1 x 48.3	20	51	58	76.2	46.1	144.5	94	M12 x 60	1.56
3 x 1/2	3.500 x 0.840	300	1.50	2.36	3.06	2.09	6.19	3.19	1/2 x 3	3.17
80 x 15	88.9 x 21.3	20	38	60	77.8	53.2	157.2	81	M12 x 75	1.44
3 x 3/4	3.500 x 1.050	300	1.50	2.32	3.06	2.09	6.19	3.19	1/2 x 3	3.21
80 x 20	88.9 x 26.7	20	38	59	77.8	53.2	157.2	81	M12 x 75	1.46
3 x 1	3.500 x 1.315	300	1.50	2.40	3.06	2.09	6.19	3.19	1/2 x 3	3.37
80 x 25	88.9 x 33.4	20	38	61	77.8	53.2	157.2	81	M12 x 75	1.53
3 x 1 1/4	3.500 x 1.660	300	2.00	2.56	3.25	2.09	6.19	3.70	1/2 x 3	3.98
80 x 32	88.9 x 42.2	20	51	65	82.6	53.2	157.2	94	M12 x 75	1.81
3 x 1 1/2	3.500 x 1.900	300	2.00	2.80	3.50	2.09	6.19	3.70	1/2 x 3	4.14
80 x 40	88.9 x 48.3	20	51	71	88.9	53.2	157.2	94	M12 x 75	1.88
3 x 2	3.500 x 2.375	300	2.50	2.76	3.50	2.09	6.19	4.25	1/2 x 3	4.55
80 x 50	88.9 x 60.3	20	64	70	88.9	53.2	157.2	108	M12 x 75	2.07
4 x 1/2	3.500 x 0.840	300	1.50	2.83	3.69	2.63	7.19	3.13	1/2 x 3	3.59
100 x 15	114.3 x 21.3	20	38	72	93.7	66.7	182.6	79.4	M12 x 75	1.63
4 x 3/4	4.500 x 1.050	300	1.50	2.79	3.69	2.63	7.19	3.13	1/2 x 3	3.61
100 x 20	114.3 x 26.7	20	38	71	93.7	66.7	182.6	79.4	M12 x 75	1.64
4 x 1	4.500 x 1.315	300	1.50	2.87	3.69	2.63	7.19	3.13	1/2 x 3	3.74
100 x 25	114.3 x 33.4	20	38	73	93.7	66.7	182.6	79.4	M12 x 75	1.70
4 x 1 1/4	4.500 x 1.660	300	2.00	3.07	3.63	2.63	7.19	4.00	1/2 x 3	4.18
100 x 32	114.3 x 42.2	20	51	78	92.1	66.7	182.6	101.6	M12 x 75	1.90
4 x 1 1/2	4.500 x 1.900	300	2.00	3.31	3.63	2.63	7.19	4.00	1/2 x 3	4.49
100 x 40	114.3 x 48.3	20	51	84	92.1	66.7	182.6	101.6	M12 x 75	2.04

Continued on next page.

Continued from previous page.

Nominal Size Run x Branch	Pipe O.D.	Max. Working Pressure (CWP)**	Hole Dia. † +3.2, -0 / +0.13, -0	Dimensions					Bolt Size	Weight
				T‡	A	B	C	D		
in	in	PSI	in	in	in	in	in	in	in	Lbs
mm	mm	Bar	mm	mm	mm	mm	mm	mm	mm	Kgs
4 x 2	4.500 x 2.375	300	2.50	3.27	4.00	2.63	7.19	4.00	½ x 3	5.00
100 x 50	114.3 x 60.3	20	64	83	101.6	66.7	182.6	101.6	M12 x 75	2.27
4 x 2½	4.500 x 2.875	300	2.75	2.87	4.00	2.63	7.19	4.44	½ x 3	5.43
100 x 65	114.3 x 73.0	20	70	73	101.6	66.7	182.6	112.7	M12 x 75	2.47
100 x 76.1 mm	4.500 x 3.000	300	2.75	2.87	4.00	2.63	7.19	4.44	½ x 3	5.65
	114.3 x 76.1	20	70	73	101.6	66.7	182.6	112.7	M12 x 75	2.57
4 x 3	4.500 x 3.500	300	3.50	3.31	4.13	2.63	7.19	5.06	½ x 3	6.41
100 x 80	114.3 x 88.9	20	89	84	104.8	66.7	182.6	128.6	M12 x 75	2.91
139.7 mm x 50	5.500 x 2.375	300	2.50	3.27	4.75	3.19	8.81	4.19	¾ x 3½	6.38
	139.7 x 60.3	20	64	83	120.7	81.0	223.8	106.4	M16 x 90	2.90
139.7 mm x 76.1 mm	5.500 x 3.000	300	2.75	3.67	4.75	3.19	8.81	4.57	¾ x 3½	7.40
	139.7 x 76.1	20	70	93	120.7	81.0	223.8	115.9	M16 x 90	3.40
139.7 mm x 80	5.500 x 3.500	300	3.50	3.82	4.75	3.19	8.81	5.19	¾ x 3½	8.41
	139.7 x 88.9	20	89	97	127.0	81.0	223.8	131.8	M16 x 90	3.82
5 x 2	5.563 x 2.375	300	2.50	3.27	4.75	3.19	8.81	4.19	¾ x 3½	6.38
125 x 50	141.3 x 60.3	20	64	83	120.7	81.0	223.8	106.4	M16 x 90	2.90
5 x 2½	5.563 x 2.875	300	2.75	3.67	4.75	3.19	8.81	4.44	¾ x 3½	7.46
125 x 65	141.3 x 73.0	20	70	93	120.7	81.0	223.8	112.7	M16 x 90	3.39
5 x 3	5.563 x 3.500	300	3.50	3.82	4.75	3.19	8.81	5.19	¾ x 3½	8.40
125 x 80	141.3 x 88.9	20	89	97	127.0	81.0	223.8	131.8	M16 x 90	3.82
165.1 mm x 32	6.500 x 1.660	300	2.00	4.41	5.13	3.72	9.87	3.63	¾ x 3½	5.57
	165.1 x 42.2	20	51	112	130.2	94.5	250.8	92.1	M16 x 90	2.53
165.1 mm x 40	6.500 x 1.900	300	2.00	4.41	5.13	3.72	9.87	3.63	¾ x 3½	6.60
	165.1 x 48.3	20	51	112	130.2	94.5	250.8	92.1	M16 x 90	3.00
165.1 mm x 50	6.500 x 2.375	300	2.50	4.37	5.13	3.72	9.87	4.19	¾ x 3½	6.97
	165.1 x 60.3	20	64	111	130.2	94.5	250.8	106.4	M16 x 90	3.17
165.1 mm x 65	6.500 x 2.875	300	2.75	3.98	5.13	3.72	9.87	4.44	¾ x 3½	7.88
	165.1 x 73.0	20	70	101	130.2	94.5	250.8	112.7	M16 x 90	3.58
165.1 mm x 76.1 mm	6.500 x 2.875	300	2.75	3.98	5.13	3.72	9.87	4.56	¾ x 3½	8.25
	165.1 x 76.1	20	70	101	130.2	94.5	250.8	115.9	M16 x 90	3.75
165.1 mm x 80	6.500 x 3.500	300	3.50	4.33	5.50	3.72	9.87	5.19	¾ x 3½	9.09
	165.1 x 88.9	20	89	110	139.7	94.5	250.8	131.8	M16 x 90	4.13
165.1 mm x 100	6.500 x 4.500	300	4.50	4.45	5.75	3.72	9.87	6.25	¾ x 3½	10.50
	165.1 x 114.3	20	114	113	146.1	94.5	250.8	158.8	M16 x 90	4.77
6 x 1¼	6.625 x 1.660	300	2.00	4.41	5.13	3.72	9.87	3.63	¾ x 3½	6.41
150 x 32	168.3 x 42.2	20	51	112	130.2	94.5	250.8	92.1	M16 x 90	2.91
6 x 1½	6.625 x 1.900	300	2.00	4.41	5.13	3.72	9.87	3.63	¾ x 3½	6.58
150 x 40	168.3 x 48.3	20	51	112	130.2	94.5	250.8	92.1	M16 x 90	2.99
6 x 2	6.625 x 2.375	300	2.50	4.37	5.13	3.72	9.87	4.19	¾ x 3½	7.00
150 x 50	168.3 x 60.3	20	64	111	130.2	94.5	250.8	106.4	M16 x 90	3.18
6 x 2½	6.625 x 2.875	300	2.75	3.98	5.13	3.72	9.87	4.44	¾ x 3½	7.88
150 x 65	168.3 x 73.0	20	70	101	130.2	94.5	250.8	112.7	M16 x 90	3.58
150 x 76.1 mm	6.625 x 2.875	300	2.75	3.98	5.13	3.72	9.87	4.56	¾ x 3½	9.02
	168.3 x 76.1	20	70	101	130.2	94.5	250.8	115.9	M16 x 90	3.58
6 x 3	6.625 x 3.500	300	3.50	4.33	5.50	3.72	9.87	5.19	¾ x 3½	9.02
150 x 80	168.3 x 88.9	20	89	110	139.7	94.5	250.8	131.8	M16 x 90	4.10
6 x 4	6.625 x 4.500	300	4.50	4.45	5.75	3.72	9.87	6.25	¾ x 3½	10.47
150 x 100	168.3 x 114.3	20	114	113	146.1	94.5	250.8	158.8	M16 x 90	4.76

† Hole diameters listed are suggested hole diameters.

‡ T: Take-Out (Center of run to end of pipe to be engaged.)

[] Important: Make special note of the hole saw size and maximum diameter allowed on these sizes, deviation could lead to joint failure.

**Working pressure is based on standard wall carbon steel pipe.

Model

7722 Mechanical Tee Grooved-End Outlet

The Model 7722 Mechanical Tee provides a fast and easy mid-pipe threaded branch outlet. The mechanical tee utilizes ductile iron housings, a grade E gasket and heat-treated carbon steel track bolts and nuts. Housings are painted orange or red, or as an option can be supplied hot dipped zinc galvanized or epoxy coated. Maximum working pressure: 300 psi (20 Bar). Gaskets are interchangeable between Models 7721 & 7722.

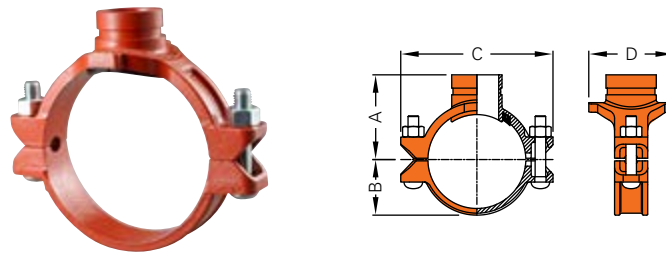

Nominal Size Run x Branch	Pipe O.D.	Max. Working Pressure (CWP)**	Hole Dia. \mp +0.13, -0 / +3.2, -0	Dimensions				Bolt Size	Weight
				A	B	C	D		
in	in	PSI	in	in	in	in	in	in	Lbs
mm	mm	Bar	mm	mm	mm	mm	mm	mm	Kgs
2 x 1	2.375 x 1.315	300	1.50	2.68	1.57	5.04	2.87	3/8 x 2 1/4	2.2
50 x 25	60.3 x 33.4	20	38	68	40	128	73	M10 x 55	1.0
2 x 1 1/4	2.375 x 1.660	300	1.75	2.80	1.57	5.04	3.22	3/8 x 2 1/4	2.2
50 x 32	60.3 x 42.2	20	45	71	40	128	82	M10 x 55	1.0
2 x 1 1/2	2.375 x 1.900	300	1.75	2.80	1.57	5.04	3.22	3/8 x 2 1/4	2.6
50 x 40	60.3 x 48.3	20	45	71	40	128	82	M10 x 55	1.2
2 1/2 x 1	2.875/3.000 x 1.315	300	1.50	2.95	1.89	5.75	2.87	1/2 x 3	4.0
65 x 25	73.0/76.1 x 33.4	20	38	75	48	146	73	M12 x 75	1.8
2 1/2 x 1 1/4	2.875/3.000 x 1.660	300	2.00	3.11	1.89	5.75	3.22	1/2 x 3	3.7
65 x 32	73.0/76.1 x 42.2	20	51	79	48	146	82	M12 x 75	1.7
2 1/2 x 1 1/2	2.875/3.000 x 1.900	300	2.00	3.11	1.89	5.75	3.22	1/2 x 3	4.2
65 x 40	73.0/76.1 x 48.3	20	51	79	48	146	82	M12 x 75	1.9
3 x 1	3.500 x 1.315	300	1.50	3.30	2.20	6.30	2.91	1/2 x 3	3.7
80 x 25	88.9 x 33.4	20	38	84	56	160	74	M12 x 75	1.7
3 x 1 1/4	3.500 x 1.660	300	2.00	3.50	2.20	6.30	3.46	1/2 x 3	4.0
80 x 32	88.9 x 42.2	20	51	89	56	160	88	M12 x 75	1.8
3 x 1 1/2	3.500 x 1.900	300	2.00	3.50	2.20	6.30	3.46	1/2 x 3	4.2
80 x 40	88.9 x 48.3	20	51	89	56	160	88	M12 x 75	1.9
3 x 2	3.500 x 2.375	300	2.50	3.58	2.20	6.30	3.98	1/2 x 3	4.8
80 x 50	88.9 x 60.3	20	64	91	56	160	101	M12 x 75	2.2
4 x 1	4.500 x 1.315	300	1.50	3.89	2.83	7.48	2.63	1/2 x 3	4.4
100 x 25	114.3 x 33.4	20	38	94	72	190	67	M12 x 75	2.0
4 x 1 1/4	4.500 x 1.660	300	2.00	3.89	2.83	7.48	3.35	1/2 x 3	4.6
100 x 32	114.3 x 42.2	20	51	99	72	190	85	M12 x 75	2.1
4 x 1 1/2	4.500 x 1.900	300	2.00	3.89	2.83	7.48	3.35	1/2 x 3	4.8
100 x 40	114.3 x 48.3	20	51	99	72	190	85	M12 x 75	2.2
4 x 2	4.500 x 2.375	300	2.50	4.13	2.83	7.48	3.98	1/2 x 3	5.9
100 x 50	114.3 x 60.3	20	64	105	72	190	101	M12 x 75	2.7
4 x 2 1/2	4.500 x 2.875	300	2.75	4.37	2.83	7.48	4.40	1/2 x 3	6.6
100 x 65	114.3 x 73.0	20	70	111	72	190	112	M12 x 75	3.0
4 x 2 1/2	4.500 x 3.000	300	2.75	4.37	2.83	7.48	4.40	1/2 x 3	6.6
100 x 65	114.3 x 76.1	20	70	111	72	190	112	M12 x 75	3.0
4 x 3	4.500 x 3.500	300	3.50	4.40	2.83	7.48	5.35	3/8 x 3 1/2	11.4
100 x 80	114.3 x 88.9	20	89	112	72	190	136	M16 x 90	5.2
5 x 2	5.500/5.563 x 2.375	300	2.50	4.88	3.39	9.29	4.00	3/8 x 3 1/2	9.2
125 x 50	139.7/141.3 x 60.3	20	64	124	86	236	102	M16 x 90	4.2
5 x 2 1/2	5.563 x 2.875	300	2.75	5.00	3.39	9.29	4.65	3/8 x 3 1/2	9.5
125 x 65	141.3 x 73.0	20	70	127	86	236	118	M16 x 90	4.2
5 x 2 1/2	5.500 x 3.000	300	2.75	5.00	3.39	9.29	4.65	3/8 x 3 1/2	9.5
125 x 65	139.7 x 76.1	20	70	127	86	236	118	M16 x 90	4.3
6 x 1 1/4	6.500/6.625 x 1.660	300	2.00	5.00	3.86	10.08	3.66	3/8 x 5 1/16	9.2
150 x 32	165.1/168.3 x 42.2	20	51	127	98	256	93	M16 x 135	4.2
6 x 1 1/2	6.500/6.625 x 1.900	300	2.00	5.00	3.86	10.08	3.66	3/8 x 5 1/16	9.5
150 x 40	165.1/168.3 x 48.3	20	51	127	98	256	93	M16 x 135	4.3
6 x 2	6.500/6.625 x 2.375	300	2.50	5.20	3.86	10.08	3.98	3/8 x 5 1/16	10.6
150 x 50	165.1/168.3 x 60.3	20	64	132	98	256	101	M16 x 135	4.8
6 x 2 1/2	6.625 x 2.875	300	2.75	5.50	3.86	10.08	4.65	3/8 x 5 1/16	12.1
150 x 65	168.3 x 73.0	20	70	140	98	256	118	M16 x 135	5.5
6 x 2 1/2	6.500 x 3.000	300	2.75	5.50	3.86	10.08	4.65	3/8 x 5 1/16	12.1
150 x 65	165.1 x 76.1	20	70	140	98	256	118	M16 x 135	5.5
6 x 3	6.500/6.625 x 3.500	300	3.50	5.50	3.86	10.08	5.39	3/8 x 5 1/16	12.3
150 x 80	165.1/168.3 x 88.9	20	89	140	98	256	137	M16 x 135	5.6

Continued on next page.

Continued from previous page.

Nominal Size Run x Branch	Pipe O.D.	Max. Working Pressure (CWP)**	Hole Dia. † +0.13, -0 / +3.2, -0	Dimensions				Bolt Size	Weight
				A	B	C	D		
in mm	in mm	PSI Bar	in mm	in mm	in mm	in mm	in mm	Lbs Kgs	
6 x 4	6.500/6.625 x 4.500	300	4.50	5.50	3.86	10.08	6.46	5/8 x 5 5/16	15.4
150 x 100	165.1/168.3 x 114.3	20	114	140	98	256	164	M16 x 135	7.0
8 x 2	8.625 x 2.375	300	2.75	6.54	4.72	12.87	3.89	3/4 x 4 3/4	12.8
200 x 50	219.1 x 60.3	20	70	166	120	327	104	M20 x 120	5.8
8 x 2 1/2	8.625 x 2.875	300	2.75	6.54	4.72	12.87	4.09	3/4 x 4 3/4	13.2
200 x 65	219.1 x 73.0	20	70	166	120	327	104	M20 x 120	6.0
8 x 2 1/2	8.625 x 3.000	300	2.75	6.54	4.72	12.87	4.09	3/4 x 4 3/4	13.2
200 x 65	219.1 x 76.1	20	70	166	120	327	104	M20 x 120	6.0
8 x 3	8.625 x 3.500	300	3.50	6.54	4.72	12.87	5.04	3/4 x 4 3/4	15.8
200 x 80	219.1 x 88.9	20	89	166	120	327	128	M20 x 120	7.2
8 x 4	8.625 x 4.500	300	4.50	6.54	4.72	12.87	6.46	3/4 x 4 3/4	16.5
200 x 100	219.1 x 114.3	20	114	166	120	327	164	M20 x 120	7.5

† Hole diameters listed are suggested hole diameters.

**Working pressure is based on roll- or cut-grooved standard wall carbon steel pipe.

Model M22 Mechanical Tee Grooved-End Outlet

The groove dimensions conform to AWWA C606. UL/FM working pressure is 300 psi (20 Bar).

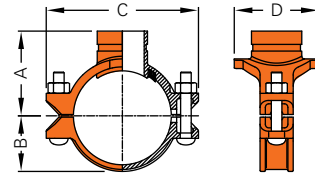

Nominal Size Run x Branch	Pipe O.D.	Max. Working Pressure (CWP)**	Hole Dia. \mp +0.13, -0 / +3.2, -0	Dimensions				Bolt Size	Weight
				A	B	C	D		
in	in	PSI	in	in	in	in	in	in	Lbs
mm	mm	Bar	mm	mm	mm	mm	mm	mm	Kgs
2 x 1	2.375 x 1.315	300	1.50	2.87	1.50	4.57	3.19	3/8 x 2 1/2	2.27
50 x 25	60.3 x 33.4	20	38	73.0	38.1	115.9	81.0	M10 x 55	1.03
2 x 1 1/4	2.375 x 1.660	300	[1.75]	3.00	1.50	4.57	3.31	3/8 x 2 1/2	2.44
50 x 32	60.3 x 42.2	20	[45]	76.2	38.1	115.9	84.0	M10 x 55	1.11
2 x 1 1/2	2.375 x 1.900	300	[1.75]	3.00	1.50	4.57	3.31	3/8 x 2 1/2	2.60
50 x 40	60.3 x 48.3	20	[45]	76.2	38.1	115.9	84.0	M10 x 55	1.18
2 1/2 x 1	2.875 x 1.315	300	1.50	3.13	1.75	5.56	3.19	1/2 x 2 3/8	2.71
65 x 25	73.0 x 33.4	20	38	79.4	44.5	141.3	81.0	M12 x 60	1.23
2 1/2 x 1 1/4	2.875 x 1.660	300	2.00	3.25	1.75	5.56	3.70	1/2 x 2 3/8	3.06
65 x 32	73.0 x 42.2	20	51	82.6	44.5	141.3	94.0	M12 x 60	1.39
2.5 x 1 1/2	2.875 x 1.900	300	2.00	3.25	1.75	5.56	3.70	1/2 x 2 3/8	3.12
65 x 40	73.0 x 48.3	20	51	82.6	44.5	141.3	94.0	M12 x 60	1.42
76.1 mm x 25	3.000 x 1.315	300	1.50	3.13	1.81	5.69	3.19	1/2 x 2 3/8	2.71
	76.1 x 33.4	20	38	79.4	46.1	144.5	81.0	M12 x 60	1.23
76.1 mm x 32	3.000 x 1.660	300	2.00	3.25	1.81	5.69	3.70	1/2 x 2 3/8	3.06
	76.1 x 42.2	20	51	82.6	46.1	144.5	94.0	M12 x 60	1.39
76.1 mm x 40	3.000 x 1.900	300	2.00	3.25	1.81	5.69	3.70	1/2 x 2 3/8	3.12
	76.1 x 48.3	20	51	82.6	46.1	144.5	94.0	M12 x 60	1.42
3 x 1	3.500 x 1.315	300	1.50	3.37	2.09	6.19	3.19	1/2 x 3	3.19
80 x 25	88.9 x 33.4	20	38	85.7	53.2	157.2	81.0	M12 x 75	1.45
3 x 1 1/4	3.500 x 1.660	300	2.00	3.56	2.09	6.19	3.70	1/2 x 3	3.70
80 x 32	88.9 x 42.2	20	51	90.5	53.2	157.2	94.0	M12 x 75	1.68
3 x 1 1/2	3.500 x 1.900	300	2.00	3.56	2.09	6.19	3.70	1/2 x 3	3.74
80 x 40	88.9 x 48.3	20	51	90.5	53.2	157.2	94.0	M12 x 75	1.70
3 x 2	3.500 x 2.375	300	2.50	3.56	2.09	6.19	4.25	1/2 x 3	4.03
80 x 50	88.9 x 60.3	20	64	90.5	53.2	157.2	108.0	M12 x 75	1.83
4 x 1	4.500 x 1.315	300	1.50	3.69	2.63	7.19	3.13	1/2 x 3	3.63
100 x 25	114.3 x 33.4	20	38	93.7	66.7	182.6	79.4	M12 x 75	1.65
4 x 1 1/4	4.500 x 1.660	300	2.00	3.63	2.63	7.19	4.00	1/2 x 3	3.96
100 x 32	114.3 x 42.2	20	51	92.1	66.7	182.6	101.6	M12 x 75	1.80
4 x 1 1/2	4.500 x 1.900	300	2.00	3.63	2.63	7.19	4.00	1/2 x 3	3.98
100 x 40	114.3 x 48.3	20	51	92.1	66.7	182.6	101.6	M12 x 75	1.81
4 x 2	4.500 x 2.375	300	2.50	4.00	2.63	7.19	4.00	1/2 x 3	4.25
100 x 50	114.3 x 60.3	20	64	101.6	66.7	182.6	101.6	M12 x 75	1.93
4 x 2 1/2	4.500 x 2.875	300	2.75	4.00	2.63	7.19	4.44	1/2 x 3	5.85
100 x 65	114.3 x 73.0	20	70	101.6	66.7	182.6	112.7	M12 x 75	2.66
100 x 76.1 mm	4.500 x 3.000	300	2.75	4.00	2.63	7.19	4.44	1/2 x 3	4.78
	114.3 x 76.1	20	70	101.6	66.7	182.6	112.7	M12 x 75	2.17
4 x 3	4.500 x 3.500	300	3.50	4.13	2.63	7.19	5.06	1/2 x 3	5.30
100 x 80	114.3 x 88.9	20	89	104.8	66.7	182.6	128.6	M12 x 75	2.41
139.7 mm x 50	5.500 x 2.375	300	2.50	4.75	3.19	8.81	4.19	3/8 x 3 1/2	5.79
	139.7 x 60.3	20	64	120.7	81.0	223.8	106.4	M16 x 90	2.63
139.7 mm x 76.1 mm	5.500 x 3.000	300	2.75	4.75	3.19	8.81	4.44	3/8 x 3 1/2	6.50
	139.7 x 76.1	20	70	120.7	81.0	223.8	112.7	M16 x 90	2.95
139.7 mm x 80	5.500 x 3.500	300	2.75	4.63	3.19	8.81	5.19	3/8 x 3 1/2	6.78
	139.7 x 88.9	20	70	117.5	81.0	223.8	131.8	M16 x 90	3.08
5 x 2	5.563 x 2.375	300	2.50	4.75	3.19	8.81	4.19	3/8 x 3 1/2	5.79
125 x 50	141.3 x 60.3	20	64	120.7	81.0	223.8	106.4	M16 x 90	2.63
5 x 2 1/2	5.563 x 2.875	300	2.75	4.75	3.19	8.81	4.44	3/8 x 3 1/2	6.34
125 x 65	141.3 x 73.0	20	70	120.7	81.0	223.8	112.7	M16 x 90	2.88
125 x 76.1 mm	5.563 x 3.000	300	2.75	4.75	3.19	8.81	4.44	3/8 x 3 1/2	6.49
	141.3 x 76.1	20	70	120.7	81.0	223.8	112.7	M16 x 90	2.95

Continued on next page.

Continued from previous page.

Nominal Size Run x Branch	Pipe O.D.	Max. Working Pressure (CWP)**	Hole Dia. † +0.13, -0 / +3.2, -0	Dimensions				Bolt Size	Weight
				A	B	C	D		
in	in	PSI	in	in	in	in	in	in	Lbs
mm	mm	Bar	mm	mm	mm	mm	mm	mm	Kgs
5 x 3	5.563 x 3.500	300	2.75	4.63	3.19	8.81	5.19	5/8 x 3 1/2	6.78
125 x 80	141.3 x 88.9	20	70	117.5	81.0	223.8	131.8	M16 x 90	3.08
165.1 mm x 32	6.500 x 1.660	300	2.00	5.13	3.72	9.87	3.63	5/8 x 3 1/2	6.03
	165.1 x 42.2	20	51	130.2	94.5	250.8	92.1	M16 x 90	2.74
165.1 mm x 40	6.500 x 1.900	300	2.00	5.13	3.72	9.87	3.63	5/8 x 3 1/2	6.12
	165.1 x 48.3	20	51	130.2	94.5	250.8	92.1	M16 x 90	2.78
165.1 mm x 50	6.500 x 2.375	300	2.50	5.13	3.72	9.87	4.19	5/8 x 3 1/2	6.40
	165.1 x 60.3	20	64	130.2	94.5	250.8	106.4	M16 x 90	2.91
6 x 2 1/2	6.625 x 2.875	300	2.75	5.13	3.72	9.87	4.44	5/8 x 3 1/2	7.08
150 x 65	168.3 x 73.0	20	70	130.2	94.5	250.8	112.7	M16 x 90	3.22
165.1 mm x 76.1 mm	6.500 x 3.000	300	2.75	5.13	3.72	9.87	4.56	5/8 x 3 1/2	7.44
	165.1 x 76.1	20	70	130.2	94.5	250.8	115.9	M16 x 90	3.38
165.1 mm x 80	6.500 x 3.500	300	3.50	5.13	3.72	9.87	5.19	5/8 x 3 1/2	8.01
	165.1 x 88.9	20	89	130.2	94.5	250.8	131.8	M16 x 90	3.64
165.1 mm x 100	6.500 x 4.500	300	4.50	5.40	3.72	9.87	6.25	5/8 x 3 1/2	8.91
	165.1 x 114.3	20	114	137.1	94.5	250.8	158.8	M16 x 90	4.05
6 x 1 1/4	6.625 x 1.660	300	2.00	5.13	3.72	9.87	3.63	5/8 x 3 1/2	6.05
150 x 32	168.3 x 42.2	20	51	130.2	94.5	250.8	92.1	M16 x 90	2.75
6 x 1 1/2	6.625 x 1.900	300	2.00	5.13	3.72	9.87	3.63	5/8 x 3 1/2	6.12
150 x 40	168.3 x 48.3	20	51	130.2	94.5	250.8	92.1	M16 x 90	2.78
6 x 2	6.625 x 2.375	300	2.50	5.13	3.72	9.87	4.19	5/8 x 3 1/2	6.42
150 x 50	168.3 x 60.3	20	64	130.2	94.5	250.8	106.4	M16 x 90	2.92
6 x 2 1/2	6.625 x 2.875	300	2.75	5.13	3.72	9.87	4.44	5/8 x 3 1/2	7.08
150 x 65	168.3 x 73.0	20	70	130.2	94.5	250.8	112.7	M16 x 90	3.22
6 x 3	6.625 x 3.500	300	3.50	5.13	3.72	9.87	5.19	5/8 x 3 1/2	8.10
150 x 80	168.3 x 88.9	20	89	130.2	94.5	250.8	131.8	M16 x 90	3.68
6 x 4	6.625 x 4.500	300	4.50	5.40	3.72	9.87	6.25	5/8 x 3 1/2	8.91
150 x 100	168.3 x 114.3	20	114	137.1	94.5	250.8	158.8	M16 x 90	4.05

† Hole diameters listed are suggested hole diameters.

[] Important: Make special note of the hole saw size and maximum diameter allowed on these sizes, deviation could lead to joint failure.

**Working pressure is based on grooved standard wall carbon steel pipe.

Model 723 Saddle-Let

The Model 723 Saddle-Let is the ideal outlet fitting for making direct connections to sprinkler heads, drop nipples and or gauges. No need for welding, just cut or drill a hole at the desired outlet location.

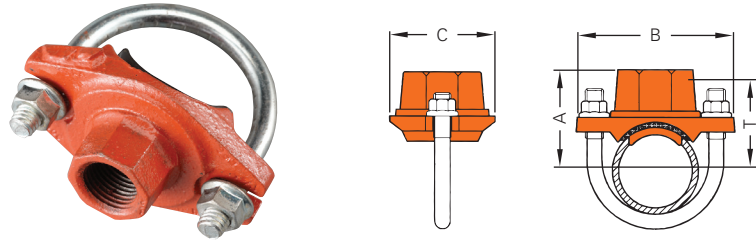

Nominal Size Run x Branch	Max. Working Pressure (CWP) PSI Bar	Hole Dia. † +3.2, -0 / +0.13, -0 in mm	Dimensions			Take-Out, T‡ D in mm	Bolt Size in	Bolt Torque Lbs-Ft Nm	Weight Lbs Kgs
			A in mm	B in mm	C in mm				
1 ¼ x ½	300	1.18	1.97	3.50	2.20	1.73	¾Ø	15-22	0.9
32 x 15	20	30	50.0	89.0	56.0	44.0	U-Bolt	20-30	0.4
1 ¼ x ¾	300	1.18	1.97	3.50	2.20	1.73	¾Ø	15-22	0.9
32 x 20	20	30	50.0	89.0	56.0	44.0	U-Bolt	20-30	0.4
1 ¼ x 1	300	1.18	2.13	3.50	2.20	1.85	¾Ø	15-22	0.9
32 x 25	20	30	54.0	89.0	56.0	47.0	U-Bolt	20-30	0.4
1 ½ x ½	300	1.18	2.09	3.50	2.24	1.81	¾Ø	15-22	0.9
40 x 15	20	30	53.0	89.0	57.0	46.0	U-Bolt	20-30	0.4
1 ½ x ¾	300	1.18	2.09	3.50	2.24	1.81	¾Ø	15-22	0.9
40 x 20	20	30	53.0	89.0	57.0	46.0	U-Bolt	20-30	0.4
1 ½ x 1	300	1.18	2.28	3.50	2.24	1.93	¾Ø	15-22	0.9
40 x 25	20	30	58.0	89.0	57.0	49.0	U-Bolt	20-30	0.4
2 x ½	300	1.18	2.36	3.82	2.24	2.09	¾Ø	15-22	0.9
50 x 15	20	30	60.0	97.0	57.0	53.0	U-Bolt	20-30	0.4
2 x ¾	300	1.18	2.36	3.82	2.24	2.09	¾Ø	15-22	0.9
50 x 20	20	30	60.0	97.0	57.0	53.0	U-Bolt	20-30	0.4
2 x 1	300	1.18	2.52	3.82	2.24	2.20	¾Ø	15-22	0.9
50 x 25	20	30	64.0	97.0	57.0	56.0	U-Bolt	20-30	0.4
2 ½ x ½	300	1.18	2.60	4.37	2.24	2.28	¾Ø	15-22	0.9
65 x 15	20	30	66.0	111.0	57.0	58.0	U-Bolt	20-30	0.4
2 ½ x ¾	300	1.18	2.60	4.37	2.24	2.28	¾Ø	15-22	0.9
65 x 20	20	30	66.0	111.0	57.0	58.0	U-Bolt	20-30	0.4
2 ½ x 1	300	1.18	2.76	4.37	2.24	2.40	¾Ø	15-22	1.1
65 x 25	20	30	70.0	111.0	57.0	61.0	U-Bolt	20-30	0.5

† Hole diameters listed are suggested hole saw diameters.
‡ T: Take-out (Center of run to end of pipe to be engaged)
* Working Pressure is based on standard wall carbon steel pipe.



Hole Cutting

The method of pipe preparation requires the cutting or drilling of a specified hole size on the centerline of the pipe. Always use the correct hole saw size as shown in the table and never use a torch for cutting a hole. After the hole has been cut all rough edges must be removed and the area within 5/8" (16 mm) of the hole should be inspected to ensure a clean smooth surface, free of any indentations or projections that could affect proper gasket sealing.

Hole Sizes for 723 Saddle-let

Saddle-Let Branch Size	Hole Dimensions		Surface Preparation "A"
	Hole Saw Size	Max dia. Allowed	
in	in	in	in
mm	mm	mm	mm
½, ¾, 1	1 ³⁄₁₆	1 ¼	3 ½
15, 20, 25	30	32	89

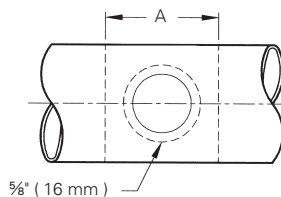

Pressure Performance Data

Ductile Iron Couplings on Carbon Steel & Stainless Steel Pipe

The following tables show maximum working pressures (CWP) of **Shurjoint** ductile iron couplings and flange adapters used on both carbon steel and stainless steel pipes. **Shurjoint** ductile iron couplings can be used in conjunction with stainless steel pipe in non-corrosive environment as the flow media does not come in direct

contact with the coupling housings but rather only the gasket. Stated pressure ratings have been developed with a safety factor. Please see Shurjoint's 2017 online installation for most recently updated instructions. Proper installation is important to proper performance.

Model Z05 on Carbon Steel Pipe

Nom. Size	Cut-Grooved		Roll-Grooved		
	XS	STD	STD	. 10	Sch. 7*
in	psi	psi	psi	psi	psi
mm	Bar	Bar	Bar	Bar	Bar
1 ¼	600	600	500	400	250
32	42	42	35	28	17
1 ½	600	600	500	400	250
40	42	42	35	28	17
2	600	600	500	400	250
50	42	42	35	28	17
2 ½	600	600	500	400	250
65	42	42	35	28	17
3	600	600	500	400	250
80	42	42	35	28	17
4	600	600	500	400	200
100	42	42	35	28	14
5	450	450	350	300	175
125	31	31	24	20	12
6	450	450	350	300	175
150	31	31	24	20	12
8	450	450	350	300	150
200	31	31	24	20	10

* Schedule 7 is in reference to "Fire Protection Specialty Pipe", or "Flow Pipe" and are based on UL and FM agency listings. Please refer to these listings for particular pipe manufacturers which can be found on our UL and FM listing pages, or downloaded from our web site.

Model Z05 on Stainless Steel Pipe

Nom. Size	Cut-Grooved		Roll-Grooved		
	Sch. 80S	Sch. 40S	Sch. 40S	Sch. 10S	Sch. 5S
in	psi	psi	psi	psi	psi
mm	Bar	Bar	Bar	Bar	Bar
1 ¼	600	600	450	300	250
32	42	42	31	20	17
1 ½	600	600	450	300	250
40	42	42	31	20	17
2	600	600	450	300	250
50	42	42	31	20	17
2 ½	600	600	450	300	250
65	42	42	31	20	17
3	600	600	450	300	250
80	42	42	31	20	17
4	600	600	450	300	200
100	42	42	31	20	14
5	450	450	300	200	
125	31	31	20	14	NR
6	450	450	300	125	
150	31	31	20	9	NR
8	450	450	300	100	
200	31	31	20	7	NR

Model K-9 on Carbon Steel Pipe

Nom. Size	Cut-Grooved		Roll-Grooved		
	XS	STD	STD	Sch. 10	Sch. 7
in	psi	psi	psi	psi	psi
mm	Bar	Bar	Bar	Bar	Bar
1 ¼	600	600	500	400	300
32	42	42	35	28	20
1 ½	600	600	500	400	300
40	42	42	35	28	20
2	600	600	500	400	300
50	42	42	35	28	20
2 ½	600	600	500	400	300
65	42	42	35	28	20
3	600	600	500	400	300
80	42	42	35	28	20
4	600	600	500	400	300
100	42	42	35	28	20
5	450	450	450	350	250
125	31	31	31	24	17
6	450	450	450	350	250
150	31	31	31	24	17
8	450	450	350	250	200
200	31	31	24	17	14
8 (K-9H)	450	450	350	250	200
200	31	31	24	17	14

Model K-9 on Stainless Steel Pipe

Nom. Size	Cut-Grooved		Roll-Grooved		
	Sch. 80S	Sch. 40S	Sch. 40S	Sch. 10S	Sch. 5S
in	psi	psi	psi	psi	psi
mm	Bar	Bar	Bar	Bar	Bar
1 ¼	600	600	450	300	250
32	42	42	31	20	17
1 ½	600	600	450	300	250
40	42	42	31	20	17
2	600	600	450	300	250
50	42	42	31	20	17
2 ½	600	600	450	300	250
65	42	42	31	20	17
3	600	600	450	300	250
80	42	42	31	20	17
4	600	600	450	300	200
100	42	42	31	20	14
5	450	450	300	200	
125	31	31	20	14	NR
6	450	450	300	125	
150	31	31	20	9	NR
8	450	450	300	100	
200	31	31	20	7	NR
8 (K-9H)	450	450	300	100	
200	31	31	20	7	NR

Model Z07 on Carbon Steel Pipe

Nom. Size	Cut-Grooved		Roll-Grooved		
	XS	STD	STD	Sch. 10	Sch. 7
in	psi	psi	psi	psi	psi
mm	Bar	Bar	Bar	Bar	Bar
1 ¼	750	750	750	600	400
32	52	52	52	42	28
1 ½	750	750	750	600	400
40	52	52	52	42	28
2	750	750	750	600	400
50	52	52	52	42	28
2 ½	750	750	750	600	400
65	52	52	52	42	28
3	750	750	750	600	400
80	52	52	52	42	28
4	750	750	750	600	400
100	52	52	52	42	28
5	750	750	750	500	350
125	52	52	52	35	24
6	700	700	700	400	300
150	48	48	48	28	20
8	600	600	600	350	250
200	42	42	42	24	17
10	500	500	500	300	200
250	35	35	35	20	14
12	400	400	400	250	150
300	28	28	28	17	10

Model Z07 on Stainless Steel Pipe

Nom. Size	Cut-Grooved		Roll-Grooved		
	Sch. 80S	Sch. 40S	Sch. 40S	Sch. 10S	Sch. 5S
in	psi	psi	psi	psi	psi
mm	Bar	Bar	Bar	Bar	Bar
1 ¼	750	750	750	750	300
32	52	52	52	52	20
1 ½	750	750	750	750	300
40	52	52	52	52	20
2	750	750	750	700	300
50	52	52	52	48	20
2 ½	750	750	750	700	300
65	52	52	52	48	20
3	750	750	750	500	300
80	52	52	52	35	20
4	750	750	750	500	250
100	52	52	52	35	17
5	750	750	650	500	NR
125	52	52	45	35	NR
6	700	700	600	300	NR
150	48	48	42	20	NR
8	600	600	450	300	NR
200	42	42	31	20	NR
10	500	500	450	150	NR
250	35	35	31	10	NR
12	400	400	400	125	NR
300	28	28	28	9	NR

Model 7771 on Carbon Steel Pipe

Nom. Size	Cut-Grooved		Roll-Grooved		
	XS	STD	STD	Sch. 10	Sch. 7
in	psi	psi	psi	psi	psi
mm	Bar	Bar	Bar	Bar	Bar
1 ½	750	750	750	600	400
40	52	52	52	42	28
2	750	750	750	600	400
50	52	52	52	42	28
2 ½	750	750	750	600	400
65	52	52	52	42	28
3	750	750	750	600	400
80	52	52	52	42	28
4	750	750	750	600	400
100	52	52	52	42	28
5	750	750	750	500	350
125	52	52	52	35	24
6	700	700	700	400	300
150	48	48	48	28	20
8	600	600	600	350	250
200	42	42	42	24	17
10	500	500	500	300	200
250	35	35	35	20	14
12	400	400	400	250	150
300	28	28	28	17	10

Model 7771 on Stainless Steel Pipe

Nom. Size	Cut-Grooved		Roll-Grooved		
	Sch. 80S	Sch. 40S	Sch. 40S	Sch. 10S	Sch. 5S
in	psi	psi	psi	psi	psi
mm	Bar	Bar	Bar	Bar	Bar
1 ½	750	750	700	500	300
40	52	52	48	35	20
2	750	750	700	500	300
50	52	52	48	35	20
2 ½	750	750	700	500	300
65	52	52	48	35	20
3	750	750	700	500	300
80	52	52	48	35	20
4	750	750	700	400	250
100	52	52	48	28	17
5	750	750	600	300	NR
125	52	52	42	20	NR
6	700	700	500	200	NR
150	48	48	35	14	NR
8	600	600	400	150	NR
200	42	42	28	10	NR
10	500	500	300	100	NR
250	35	35	20	7	NR
12	400	400	250	100	NR
300	28	28	17	7	NR

Model XH-1000 on Carbon Steel Pipe

Nom. Size	Cut-Grooved		Roll-Grooved		
	XS	STD	STD	Sch. 10	Sch. 7
in	psi	psi	psi	psi	psi
mm	Bar	Bar	Bar	Bar	Bar
2	1000	1000	1000	750	NR
50	69	69	69	52	NR
2 ½	1000	1000	1000	600	NR
65	69	69	69	42	NR
3	1000	1000	1000	600	NR
80	69	69	69	42	NR
4	1000	1000	1000	600	NR
100	69	69	69	42	NR
6	1000	1000	1000	450	NR
150	69	69	69	31	NR
8	800	800	800	300	NR
200	55	55	55	20	NR
10	800	800	800	300	NR
250	55	55	55	20	NR
12	800	800	800	200	NR
300	55	55	55	14	NR

Model XH-1000 on Stainless Steel Pipe

Nom. Size	Cut-Grooved		Roll-Grooved		
	Sch. 80S	Sch. 40S	Sch. 40S	Sch. 10S	Sch. 5S
in	psi	psi	psi	psi	psi
mm	Bar	Bar	Bar	Bar	Bar
2	1000	1000	750	700	NR
50	69	69	52	48	NR
2 ½	1000	1000	750	700	NR
65	69	69	52	48	NR
3	1000	1000	750	500	NR
80	69	69	52	35	NR
4	1000	1000	750	500	NR
100	69	69	52	35	NR
6	1000	1000	750	350	NR
150	69	69	52	24	NR
8	800	800	650	350	NR
200	55	55	45	24	NR
10	800	800	600	300	NR
250	55	55	42	20	NR
12	800	800	600	300	NR
300	55	55	42	20	NR

Model G28 on Carbon Steel Pipe

Nom. Size	Cut-Grooved		Roll-Grooved		
	XS	STD	STD	Sch. 10	Sch. 7
in	psi	psi	psi	psi	psi
mm	Bar	Bar	Bar	Bar	Bar
1½	300	300	300	300	
40	20	20	20	20	NR
2	300	300	300	300	
50	20	20	20	20	NR
2½	300	300	300	300	
65	20	20	20	20	NR
3	300	300	300	300	
80	20	20	20	20	NR
4	300	300	300	300	
100	20	20	20	20	NR
5	300	300	300	300	
125	20	20	20	20	NR
6	300	300	300	300	
150	20	20	20	20	NR
8	300	300	300	250	
200	20	20	20	17	NR
10	300	300	300	250	
250	20	20	20	17	NR

Model G28 on Stainless Steel Pipe

Nom. Size	Cut-Grooved		Roll-Grooved		
	Sch. 80S	Sch. 40S	Sch. 40S	Sch. 10S	Sch. 5S
in	psi	psi	psi	psi	psi
mm	Bar	Bar	Bar	Bar	Bar
1½	300	300	300	300	
40	20	20	20	20	NR
2	300	300	300	300	
50	20	20	20	20	NR
2½	300	300	300	300	
65	20	20	20	20	NR
3	300	300	300	300	
80	20	20	20	20	NR
4	300	300	300	175	
100	20	20	20	12	NR
5	300	300	250	150	
125	20	20	17	10	NR
6	300	300	250	150	
150	20	20	17	10	NR
8	300	300	200		
200	20	20	14	NR	NR
10	300	300	200		
250	20	20	14	NR	NR

Model 7705 on Carbon Steel Pipe

Nom. Size	Cut-Grooved		Roll-Grooved		
	XS	STD	STD	Sch. 10	Sch. 7
in	psi	psi	psi	psi	psi
mm	Bar	Bar	Bar	Bar	Bar
1	600	600	500	400	300
25	42	42	35	28	20
1¼	600	600	500	400	300
32	42	42	35	28	20
1½	600	600	500	400	300
40	42	42	35	28	20
2	600	600	500	400	300
50	42	42	35	28	20
2½	600	600	500	400	300
65	42	42	35	28	20
3	600	600	500	400	300
80	42	42	35	28	20
4	600	600	500	400	300
100	42	42	35	28	20
5	450	450	450	350	250
125	31	31	31	24	17
6	450	450	450	350	250
150	31	31	31	24	17
8	450	450	300	250	200
200	31	31	20	17	14
10	350	350	300	200	175
250	24	24	20	14	12
12	350	350	300	200	175
300	24	24	20	14	12

Model 7705 on Stainless Steel Pipe

Nom. Size	Cut-Grooved		Roll-Grooved		
	Sch. 80S	Sch. 40S	Sch. 40S	Sch. 10S	Sch. 5S
in	psi	psi	psi	psi	psi
mm	Bar	Bar	Bar	Bar	Bar
1	600	600	750	500	250
25	42	42	52	35	17
1¼	600	600	750	500	250
32	42	42	52	35	17
1½	600	600	650	500	250
40	42	42	45	35	17
2	600	600	500	500	250
50	42	42	35	35	17
2½	600	600	500	500	250
65	42	42	35	35	17
3	600	600	500	400	250
80	42	42	35	28	17
4	600	600	500	400	200
100	42	42	35	28	14
5	450	450	450	350	
125	31	31	31	24	NR
6	450	450	300	300	
150	31	31	20	20	NR
8	450	450	300	300	
200	31	31	20	20	NR
10	350	350	200	75	
250	24	24	14	5	NR
12	350	350	200	50	
300	24	24	14	3	NR

Model 7707 on Carbon Steel Pipe

Nom. Size	Cut-Grooved		Roll-Grooved		
	XS	STD	STD	Sch. 10	Sch. 7
in	psi	psi	psi	psi	psi
mm	Bar	Bar	Bar	Bar	Bar
¾	1000	1000	1000* / 750	750* / 600	500
20	69	69	69* / 52	52* / 42	35
1	1000	1000	1000* / 750	750* / 600	500
25	69	69	69* / 52	52* / 42	35
1¼	1000	1000	1000* / 750	750* / 600	500
32	69	69	69* / 52	52* / 42	35
1½	1000	1000	1000* / 750	750* / 600	500
40	69	69	69* / 52	52* / 42	35
2	1000	1000	1000* / 750	750* / 600	500
50	69	69	69* / 52	52* / 42	35
2½	1000	1000	1000* / 750	600	500
65	69	69	69* / 52	42	35
3	1000	1000	1000* / 750	600	500
80	69	69	69* / 52	42	35
4	1000	1000	1000* / 750	600	400
100	69	69	69* / 52	42	28
5	1000	1000	1000* / 750	500	350
125	69	69	69* / 52	35	24
6	1000	1000	1000* / 700	450	300
150	69	69	69* / 48	31	20
8	800	800	800* / 600	350	250
200	55	55	55* / 42	24	17
10	800	800	800* / 550	300	200
250	55	55	55* / 38	20	14
12	800	800	800* / 500	300	200
300	55	55	55* / 35	20	14

Model 7707 on Stainless Steel Pipe

Nom. Size	Cut-Grooved		Roll-Grooved		
	Sch. 80S	Sch. 40S	Sch. 40S	Sch. 10S	Sch. 5S
in	psi	psi	psi	psi	psi
mm	Bar	Bar	Bar	Bar	Bar
¾	750	750	750	500	325
20	52	52	52	35	22
1	750	750	750	500	325
25	52	52	52	35	22
1¼	750	750	750	500	325
32	52	52	52	35	22
1½	750	750	750	500	325
40	52	52	52	35	22
2	750	750	750	500	325
50	52	52	52	35	22
2½	750	750	750	500	325
65	52	52	52	35	22
3	750	750	750	500	325
80	52	52	52	35	22
4	750	750	750	500	250
100	52	52	52	35	17
5	750	750	650	500	
125	52	52	45	35	NR
6	750	750	500	200	
150	52	52	35	14	NR
8	600	600	450	300	
200	42	42	31	20	NR
10	600	600	400	125	
250	42	42	28	9	NR
12	600	600	400	125	
300	42	42	28	9	NR

Note: * Maximum line pressure, including surge, to which a joint should be subjected.

Model 7706 on Carbon Steel Pipe

Nom. Size	Cut-Grooved		Roll-Grooved		
	XS	STD	STD	Sch. 10	Sch. 7
in	psi	psi	psi	psi	psi
mm	Bar	Bar	Bar	Bar	Bar
1 1/2 x 1 1/4	500	500	500	350	300
40 x 32	35	35	35	24	20
2 x 1 1/2	500	500	500	350	300
50 x 40	35	35	35	24	20
2 1/2 x 2	500	500	500	350	300
65 x 50	35	35	35	24	20
3 x 2	500	500	500	350	300
80 x 50	35	35	35	24	20
3 x 2 1/2	500	500	500	350	300
80 x 65	35	35	35	24	20
4 x 2	500	500	500	350	300
100 x 50	35	35	35	24	20
4 x 2 1/2	500	500	500	350	300
100 x 65	35	35	35	24	20
4 x 3	500	500	500	300	250
100 x 80	35	35	35	20	17
5 x 4	400	400	400	300	250
125 x 100	28	28	28	20	17
6 x 3	400	400	400	300	200
150 x 80	28	28	28	20	14
6 x 4	400	400	400	300	175
150 x 100	28	28	28	20	12
8 x 6	400	400	400	300	175
200 x 150	28	28	28	20	12

Model 7706 on Stainless Steel Pipe

Nom. Size	Cut-Grooved		Roll-Grooved		
	Sch. 80S	Sch. 40S	Sch. 40S	Sch. 10S	Sch. 5S
in	psi	psi	psi	psi	psi
mm	Bar	Bar	Bar	Bar	Bar
1 1/2 x 1 1/4	500	500	350	300	250
40 x 32	35	35	24	20	17
2 x 1 1/2	500	500	350	300	250
50 x 40	35	35	24	20	17
2 1/2 x 2	500	500	350	300	250
65 x 50	35	35	24	20	17
3 x 2	500	500	350	300	250
80 x 50	35	35	24	20	17
3 x 2 1/2	500	500	350	300	250
80 x 65	35	35	24	20	17
4 x 2	500	500	350	300	250
100 x 50	35	35	24	20	17
4 x 2 1/2	500	500	350	300	200
100 x 65	35	35	24	20	14
4 x 3	500	500	300	250	200
100 x 80	35	35	20	17	14
5 x 4	400	400	300	250	
125 x 100	28	28	20	17	NR
6 x 3	400	400	300	200	NR
150 x 80	28	28	20	14	NR
6 x 4	400	400	300	175	NR
150 x 100	28	28	20	12	
8 x 6	400	400	300	175	NR
200 x 150	28	28	20	12	

Model C-7 on Carbon Steel Pipe

Nom. Size	Cut-Grooved		Roll-Grooved		
	XS	STD	STD	Sch. 10	Sch. 7
in	psi	psi	psi	psi	psi
mm	Bar	Bar	Bar	Bar	Bar
1 1/2 x *	500	500	500	350	300
40 x *	35	35	35	24	20
2 x *	500	500	500	350	300
50 x *	35	35	35	24	20
2 1/2 x *	500	500	500	350	300
65 x *	35	35	35	24	20
3 x *	500	500	500	300	300
80 x *	35	35	35	24	20
4 x *	500	500	500	300	300
100 x *	35	35	35	24	20
6 x *	400	400	400	350	300
150 x *	28	28	28	24	20

* = all branch sizes, threaded and grooved

Model C-7 on Stainless Steel Pipe

Nom. Size	Cut-Grooved		Roll-Grooved		
	Sch. 80S	Sch. 40S	Sch. 40S	Sch. 10S	Sch. 5S
in	psi	psi	psi	psi	psi
mm	Bar	Bar	Bar	Bar	Bar
1 1/2 x *	500	500	350	300	250
40 x *	35	35	24	20	17
2 x *	500	500	350	300	250
50 x *	35	35	24	20	17
2 1/2 x *	500	500	350	300	250
65 x *	35	35	24	20	17
3 x *	500	500	350	300	250
80 x *	35	35	24	20	17
4 x *	500	500	350	300	250
100 x *	35	35	24	20	17
6 x *	400	400	300	300	250
150 x *	28	28	20	20	17

* = all branch sizes, threaded and grooved

Model 7043 on Carbon Steel Pipe

Nom. Size	Cut-Grooved		Roll-Grooved		
	XS	STD	STD	Sch. 10	Sch. 7
in	psi	psi	psi	psi	psi
mm	Bar	Bar	Bar	Bar	Bar
2	750	750	750	500	
50	52	52	52	35	NR
2 1/2	750	750	750	500	
65	52	52	52	35	NR
3	750	750	750	500	
80	52	52	52	35	NR
4	750	750	750	500	
100	52	52	52	35	NR
5	750	750	750	450	
125	52	52	52	31	NR
6	750	750	750	450	
150	52	52	52	31	NR
8	750	750	750	300	
200	52	52	52	20	NR
10	750	750	750	300	
250	52	52	52	20	NR
12	750	750	750	250	
300	52	52	52	17	NR

Hydrostatic shell test: 1125 psi (77 Bar) per ANSI B16.5

Model 7043 on Stainless Steel Pipe

Nom. Size	Cut-Grooved		Roll-Grooved		
	Sch. 80S	Sch. 40S	Sch. 40S	Sch. 10S	Sch. 5S
in	psi	psi	psi	psi	psi
mm	Bar	Bar	Bar	Bar	Bar
2	400	400	400		
50	28	28	28	NR	NR
2 1/2	400	400	400		
65	28	28	28	NR	NR
3	400	400	400		
80	28	28	28	NR	NR
4	300	300	300		
100	20	20	20	NR	NR
5	300	300	250		
125	20	20	17	NR	NR
6	300	300	200		
150	20	20	14	NR	NR
8	250	250	150		
200	17	17	10	NR	NR
10	250	250	150		
250	17	17	10	NR	NR
12	250	250	150		
300	17	17	10	NR	NR

Model 7041 on Carbon Steel Pipe

Nom. Size	Cut-Grooved		Roll-Grooved		
	XS	STD	STD	Sch. 10	Sch. 7
in	psi	psi	psi	psi	psi
mm	Bar	Bar	Bar	Bar	Bar
2	300	300	300	250	
50	20	20	20	17	NR
2½	300	300	300	250	
65	20	20	20	17	NR
3	300	300	300	250	
80	20	20	20	17	NR
4	300	300	300	250	
100	20	20	20	17	NR
5	300	300	300	250	
125	20	20	20	17	NR
6	300	300	300	250	
150	20	20	20	17	NR
8	300	300	300	200	
200	20	20	20	14	NR
10	300	300	300	200	
250	20	20	20	14	NR
12	300	300	300	200	
300	20	20	20	14	NR
14	300	300	300	200	
350	20	20	20	14	NR
16	300	300	300	175	
400	20	20	20	12	NR
18	300	300	300	175	
450	20	20	20	12	NR
20	300	300	300	150	
500	20	20	20	10	NR
24	300	300	300	150	
600	20	20	20	10	NR

Model 7041 on Stainless Steel Pipe

Nom. Size	Cut-Grooved		Roll-Grooved		
	Sch. 80S	Sch. 40S	Sch. 40S	Sch. 10S	Sch. 5S
in	psi	psi	psi	psi	psi
mm	Bar	Bar	Bar	Bar	Bar
2	300	300	275	275	250
50	20	20	19	19	17
2½	300	300	275	275	250
65	20	20	19	19	17
3	300	300	275	275	250
80	20	20	19	19	17
4	300	300	275	275	250
100	20	20	19	19	17
5	300	300	275	200	200
125	20	20	19	14	14
6	300	300	250	200	200
150	20	20	17	14	14
8	300	300	200	75	NR
200	20	20	14	5	NR
10	300	300	200	75	NR
250	20	20	14	5	NR
12	300	300	200	50	NR
300	20	20	14	3	NR
14	250	250	125	NR	NR
350	17	17	9	NR	NR
16	250	250	125	NR	NR
400	17	17	9	NR	NR
18	250	250	125	NR	NR
450	17	17	9	NR	NR
20	250	250	100	NR	NR
500	17	17	7	NR	NR
24	250	250	100	NR	NR
600	17	17	7	NR	NR

Model 7707N on Carbon Steel Pipe

Nom. Size	Cut-Grooved	Roll-Grooved	
	XS (0.500")	STD (0.375")	LW (0.312")
in	psi	psi	psi
mm	Bar	Bar	Bar
14	300	300	250
350	20	20	17
16	300	300	250
400	20	20	17
18	300	300	250
450	20	20	17
20	300	300	250
500	20	20	17
22	300	300	250
550	20	20	17
24	300	300	250
600	20	20	17

Model Z07N on Carbon Steel Pipe

Nom. Size	Cut-Grooved	Roll-Grooved	
	XS (0.500")	STD (0.375")	LW (0.312")
in	psi	psi	psi
mm	Bar	Bar	Bar
14	NR	250	200
350	NR	17	14
16	NR	250	200
400	NR	17	14
18	NR	250	200
450	NR	17	14
20	NR	250	200
500	NR	17	14
24	NR	250	200
600	NR	17	14

Model 7707L on Carbon Steel Pipe

Nom. Size	Cut-Grooved	Roll-Grooved	
	XS (0.500")	STD (0.375")	LW (0.312")
in	psi	psi	psi
mm	Bar	Bar	Bar
28	250	175	125
700	17	12	9
30	250	175	125
750	17	12	9
32	250	175	125
800	17	12	9
34	250	175	125
850	17	12	9
36	250	175	125
900	17	12	9
40	250	175	125
1000	17	12	9
42	250	175	125
1050	17	12	9

Stated pressure ratings have been developed with a safety factor. Please see Shurjoint's 2017 online installation instructions for most recently updated instructions. Proper installation is important to proper performance.

Section 2

Cast & Wrought Grooved Fittings

Shurjoint Grooved Fittings	56
Flow Data / Friction Resistance	56
Ductile Iron Grooved Fittings	
7110 / 7111 / 7112 / 7113 Elbows.....	57
7120 / 7135 / 7130 Tee, Cross & Lateral.....	58
7121 Reducing Tee	59
7150 / 7151 Concentric & Eccentric Reducers.....	61
7160 / 7160P / 7160T Caps	62
7160H Dome End Cap.....	63
7110LR / 7111LR / 7137 Elbows & True-Y.....	63
7112G / 7110-B Elbows.....	64
901 / 903 / 7110DR / 7127 Elbows & Tee	65
7125 Bullhead Tee.....	66
7150F / 7150M Reducers.....	67
899 / 55 / 56 End-All & Nipples.....	68
57 / 58 / 59 Nipples	69
850 / 851 / 853 Sprinkler Hubs	70
7114 / 7122 / 7133 Hydrant Elbow & Tees	71
Wrought Grooved Fittings	
W110LR / W111LR / W120 / W160 Elbows, Tee & Cap.....	72
W121 Reducing Tee.....	73
W150 / W151 Concentric & Eccentric Reducers	74
W135 / W137 Cross & True-Y	75
L90-3D / L60-3D / L45-3D / L30-3D / L22-3D / L11-3D Elbows	76
L90-5D / L60-5D / L45-5D / L30-5D / L22-5D / L11-5D Elbows	77
L90-6D / L60-6D / L45-6D / L30-6D / L22-6D / L11-6D Elbows	78
Extra Heavy Grooved Fittings	
10EP / 11EP / 20EP / 35EP / 22EP Elbows, Tees & Cross	79

Shurjoint Grooved Fittings

Shurjoint offers a wide range of grooved-end fittings in sizes through 24" (600 mm). Fittings are available in a number of styles and configurations to support a variety of applications. **Shurjoint** grooved-end fittings are manufactured and designed to meet ASTM F1548 and ANSI/AWWA C606 requirements for use with grooved mechanical couplings conforming to ASTM F1476. For sizes not specified in these standards, please refer to applicable groove specifications shown in this catalog.



Most fittings are provided in ductile iron conforming to ASTM A536 Gr. 65-45-12 and or ASTM A395 Gr. 65-45-15. Some styles and sizes larger than 14" (350 mm) are fabricated from carbon steel pipe to ASTM A53 Gr. B or fabricated of segmentally welded steel of the same or equivalent grade. Fittings are painted orange or red, or as an option can be supplied hot-dip galvanized or epoxy coated.



Rubber Lined Fittings

Shurjoint ductile iron grooved end fittings are also available with rubber lining for abrasive services. Contact Shurjoint for further information.



For abrasive services

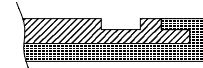

For abrasive and corrosive services

Flow Data / Frictional Resistance

Expressed as equivalent length of straight pipe

Nominal Size	Pipe O.D.	Pipe Wall Thickness	Elbows					Tees	
			#7110 90°	#901 90°	#7110LR 90°	#7111 45°	#7111LR 45°	#7120	#903
			Std. Radius	Short Radius	1½ D. LR	Std. Radius	1½ D. LR	Branch	Branch
in	in	in	feet	feet	feet	feet	feet	feet	
mm	mm	mm	meters	meters	meters	meters	meters	meters	
1	1.315	0.133	1.7	—	—	0.8	—	4.2	—
25	33.4	3.4	0.5	—	—	0.2	—	1.3	—
1¼	1.660	0.140	2.5	2.5	—	1.0	—	4.7	4.7
32	42.2	3.6	0.8	0.8	—	0.3	—	1.4	1.4
1½	1.900	0.154	3.5	3.5	—	1.5	—	6.5	6.5
40	48.3	4.0	1.1	1.1	—	0.5	—	2.0	2.0
2	2.375	0.203	4.0	4.0	2.5	1.7	1.1	8.5	8.5
50	60.3	5.2	1.2	1.2	0.8	0.5	0.3	2.6	2.6
2½	2.875	0.197	4.5	4.5	2.9	2.0	1.4	10.0	10.0
65	73.0	5.0	1.4	1.4	0.9	0.6	0.4	3.1	3.1
3	3.500	0.237	5.0	5.0	3.8	2.5	1.5	12.0	12.0
80	88.9	6.3	1.5	1.5	1.2	0.8	0.5	3.7	3.7
4	4.500	0.220	6.7	6.7	5.0	3.0	2.1	15.0	15.0
100	114.3	5.6	2.0	2.0	1.5	0.9	0.6	4.6	4.6
5	5.563	0.258	7.5	7.5	6.0	4.0	2.5	19.0	19.0
125	141.3	6.6	2.3	2.3	1.8	1.2	0.6	5.8	5.8
6	6.625	0.280	9.0	9.0	7.5	4.5	3.0	22.0	22.0
150	168.3	7.1	2.7	2.7	2.3	1.4	0.9	6.7	6.7
8	8.625	0.322	13.0	13.0	9.8	6.5	4.0	33.0	33.0
200	219.1	8.2	4.0	4.0	3.0	2.0	1.2	10.1	10.1
10	10.750	0.365	17.0	—	12.0	8.3	5.0	41.0	—
250	273.0	8.8	5.2	—	3.7	2.5	1.5	12.5	—
12	12.750	0.375	20.0	—	14.5	10.0	6.0	49.0	—
300	323.9	9.5	6.1	—	4.4	3.1	1.8	14.9	—
14	14.000	0.375	24.5	22.3	—	13.8	—	69.9	69.9
350	355.6	9.5	7.5	6.8	—	4.8	—	21.3	21.3
16	16.000	0.375	28.0	25.3	—	15.8	—	80.0	80.0
400	406.4	9.5	8.5	7.7	—	4.8	—	24.4	24.4
18	18.000	0.375	31.0	28.2	—	18.7	—	89.9	89.9
450	457.2	9.5	9.5	8.6	—	5.7	—	27.4	27.4
20	20.000	0.375	34.0	30.8	—	20.9	—	100.0	100.0
500	508.0	9.5	10.4	9.4	—	6.3	—	30.5	30.5
24	24.000	0.375	42.0	37.7	—	24.2	—	120.0	120.0
600	609.6	9.5	12.8	11.5	—	7.4	—	36.6	36.6

The values listed in this table express the frictional resistance of representative Shurjoint fittings as equivalent feet (meters) of straight pipe. For the branch of a tee that is reduced in size, use the value that corresponds to the branch size. For example, the branch value of a 4" x 4" x 3" tee is 12.0 feet (3.7 meters). For fittings not listed in this table, the equivalent length of straight pipe can be estimated from the data provided. For example, the flow resistance of a 22½° elbow is approximately one half that of a 45° elbow.

Model

7110 90° Elbow
7112 22½° Elbow

7111 45° Elbow
7113 11¼° Elbow

Shurjoint ductile iron grooved-end fittings are made of ductile iron per ASTM A536 Gr. 65-45-12 and or ASTM A395 Gr. 65-45-15. C-E dimensions are manufacturer's standard. See page 72 for wrought steel grooved-end fittings.

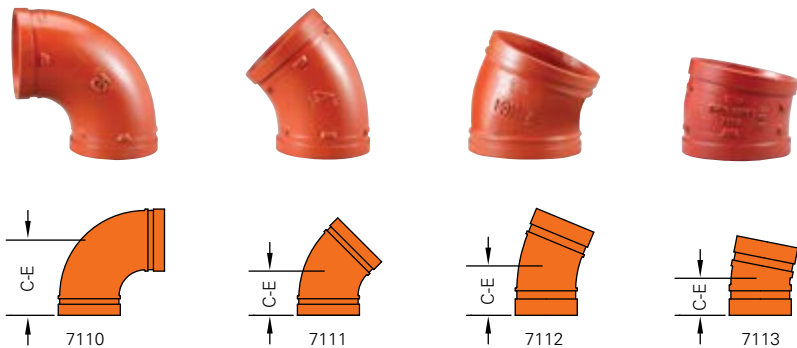

Nominal Size	Pipe O. D.	#7110 90° Elbow		#7111 45° Elbow		#7112 22½° Elbow		#7113 11¼° Elbow	
		C - E	Weight	C - E	Weight	C - E	Weight	C - E	Weight
in	in	in	Lbs	in	Lbs	in	Lbs	in	Lbs
mm	mm	mm	Kgs	mm	Kgs	mm	Kgs	mm	Kgs
1	1.315	2.25	0.7	1.75	0.5	—	—	1.38	0.4
25	33.4	57	0.3	45	0.2	—	—	35	0.2
1¼	1.660	2.75	1.1	1.75	0.7	1.75	0.7	1.38	0.7
32	42.2	70	0.5	45	0.3	45	0.3	35	0.3
1½	1.900	2.75	1.3	1.75	0.9	1.75	1.1	1.38	0.7
40	48.3	70	0.6	45	0.4	45	0.5	35	0.3
2	2.375	3.25	2.0	2.00	1.5	1.88	1.6	1.38	1.0
50	60.3	83	0.9	51	0.7	48	0.7	35	0.4
2½	2.875	3.75	2.6	2.25	2.1	2.01	2.6	1.50	1.6
65	73.0	95	1.2	57	0.9	51	1.2	38	0.7
76.1 mm	3.000	3.75	3.1	2.25	2.1	2.01	2.5	1.50	1.7
	76.1	95	1.4	57	0.9	51	1.1	38	0.8
3	3.500	4.25	4.3	2.50	2.9	2.25	3.1	1.50	1.8
80	88.9	108	2.0	64	1.3	57	1.4	38	0.8
101.6 mm	4.000	4.50	5.5	—	—	—	—	—	—
	101.6	114	2.5	—	—	—	—	—	—
108.0 mm	4.250	5.00	5.5	3.00	4.4	—	—	—	—
	108.0	127	2.5	76	2.0	—	—	—	—
4	4.500	5.00	6.9	3.00	4.4	2.88	4.4	1.75	2.2
100	114.3	127	3.1	76	2.0	73	2.0	45	1.0
133.0 mm	5.250	5.50	9.0	3.25	5.9	—	—	—	—
	133.0	140	4.1	83	2.7	—	—	—	—
139.7 mm	5.500	5.50	9.5	3.25	6.4	—	—	2.00	4.5
	139.7	140	4.3	83	2.9	—	—	51	2.0
5	5.563	5.50	11.0	3.25	6.6	—	—	2.00	4.5
125	141.3	140	5.0	83	3.0	—	—	51	2.1
159.0 mm	6.250	6.50	13.2	3.50	8.4	—	—	—	—
	159.0	165	6.0	89	3.8	—	—	—	—
165.1 mm	6.500	6.50	12.5	3.50	8.9	3.12	10.7	2.00	5.5
	165.1	165	5.7	89	4.0	79	4.9	51	2.5
6	6.625	6.50	12.8	3.50	8.9	3.12	9.3	2.00	5.5
150	168.3	165	5.8	89	4.0	79	4.2	51	2.5
8	8.625	7.75	28.7	4.25	19.0	3.88	17.8	2.00	10.1
200	219.1	197	13.0	108	8.6	98	8.1	51	4.6
10	10.750	9.00	53.1	4.75	34.2	4.38	39.0	2.13	22.1
250	273.0	229	24.1	121	15.5	111	17.7	54	10.0
12	12.750	10.00	81.0	5.25	49.5	4.88	43.0	2.25	27.3
300	323.9	254	36.7	133	22.5	124	19.5	57	12.4
200 JIS	8.516	7.75	27.2	4.25	18.5	3.88	13.9	—	—
	216.3	197	12.4	108	8.4	98	6.3	—	—
250 JIS	10.528	9.00	52.8	4.75	34.2	—	—	—	—
	267.4	229	24.0	121	15.5	—	—	—	—
300 JIS	12.539	10.00	77.0	5.25	49.5	—	—	—	—
	318.5	254	35.0	133	22.5	—	—	—	—
14	14.000	11.00	77.5	6.00	48.4	—	—	—	—
350	355.6	280	35.2	152	22.0	—	—	—	—
16	16.000	12.00	94.6	7.25	96.8	—	—	—	—
400	406.4	305	43.0	184	44.0	—	—	—	—

Model

7120 Tee

7135 Cross

7130 45° Lateral

Shurjoint ductile iron grooved-end fittings are made of ductile iron per ASTM A536 Gr. 65-45-12 and or ASTM A395 Gr. 65-45-15. C-E dimensions are manufacturer's standard. See page 72 for wrought steel grooved-end fittings.

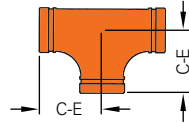

7120

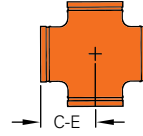

7135

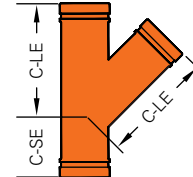

7130

Nominal Size	Pipe O.D.	#7120 Tee		#7135 Cross		#7130 45° Lateral		
		C - E	Weight	C - E	Weight	C - LE	C - SE	Weight
in	in	in	Lbs	in	Lbs	in	in	Lbs
mm	mm	mm	Kgs	mm	Kgs	mm	mm	Kgs
1	1.315	2.25	0.9	2.25	—	—	—	—
25	33.4	57	0.4	57	—	—	—	—
1¼	1.660	2.75	1.5	2.75	—	—	—	—
32	42.2	70	0.7	70	—	—	—	—
1½	1.900	2.75	2.0	2.75	—	—	—	—
40	48.3	70	0.9	70	—	—	—	—
2	2.375	3.25	2.9	3.25	2.7	7.00	2.75	4.4
50	60.3	83	1.3	83	1.2	178	70	2.0
2½	2.875	3.75	4.8	3.75	6.6	7.75	3.00	6.2
65	73.0	95	2.2	95	3.0	197	76	2.8
76.1 mm	3.000	3.75	5.1	3.75	6.6	7.75	3.00	6.2
	76.1	95	2.3	95	3.0	197	76	2.8
3	3.500	4.25	6.8	4.25	6.8	8.50	3.25	9.2
80	88.9	108	3.1	108	3.1	216	83	4.2
4	4.500	5.00	9.9	5.00	11.5	10.50	3.75	17.6
100	114.3	127	4.5	127	5.2	267	95	8.0
	4.250	5.00	9.0	—	—	—	—	—
108.0 mm	108.0	127	4.1	—	—	—	—	—
	5.250	5.50	13.2	—	—	—	—	—
133.0 mm	133.0	140	6.0	—	—	—	—	—
	5.500	5.50	14.3	5.50	13.0	12.50	4.00	27.5
139.7 mm	139.7	140	6.5	140	5.9	318	102	12.5
	5.563	5.50	14.3	5.50	13.0	12.50	4.00	27.5
125	141.3	140	6.5	140	5.9	318	102	12.5
6	6.250	6.50	18.9	—	—	—	—	—
150	159.0	165	8.6	—	—	—	—	—
165.1 mm	6.500	6.50	21.7	6.50	32.0	14.00	4.50	40.7
	165.1	165	9.9	165	14.5	356	114	18.5
6	6.625	6.50	22.0	6.50	32.0	14.00	4.50	40.7
150	168.3	165	10.0	165	14.5	356	114	18.5
8	8.625	7.75	44.0	7.75	44.1	18.00	6.00	70.4
200	219.1	197	20.0	197	20.0	457	152	32.0
10	10.750	9.00	68.2	—	—	20.50	6.50	138.9
250	273.0	229	31.0	—	—	521	165	63.0
12	12.750	10.00	96.7	—	—	23.00	7.00	201.7
300	323.9	254	43.9	—	—	584	178	91.5
200 JIS	8.516	7.75	44.0	—	—	—	—	—
	216.3	197	20.0	—	—	—	—	—
250 JIS	10.528	9.00	68.2	—	—	—	—	—
	267.4	229	31.0	—	—	—	—	—
300 JIS	12.539	10.00	96.7	—	—	—	—	—
	318.5	254	43.9	—	—	—	—	—
14	14.000	11.00	114.6	—	—	—	—	—
350	355.6	280	52.0	—	—	—	—	—

Model 7121 Reducing Tee

Shurjoint ductile iron grooved-end fittings are made of ductile iron per ASTM A536 Gr. 65-45-12 and or ASTM A395 Gr. 65-45-15. C-E dimensions are manufacturer's standard. See page 73 for wrought steel grooved-end fittings.

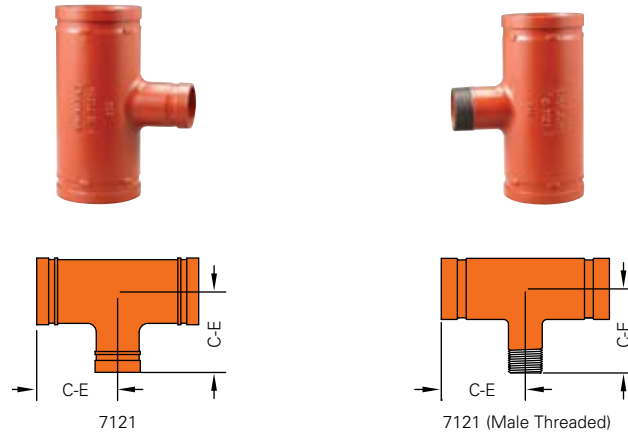

Nominal Size	Pipe O.D.	Standard C - E	Threaded Br. C - E	Weight	Nominal Size	Pipe O. D.	Standard C - E	Threaded Br. C - E	Weight
in	in	in	in	Lbs	in	in	in	in	Lbs
mm	mm	mm	mm	Kgs	mm	mm	mm	mm	Kgs
2 x 2 x 1 1/4	2.375 x 2.375 x 1.660	3.25	—	2.6	5 x 5 x 2 1/2	5.563 x 5.563 x 2.875	5.50	5.50*	12.8
50 x 50 x 32	60.3 x 60.3 x 42.2	83	—	1.2	125 x 125 x 65	141.3 x 141.3 x 73.0	140	140	5.8
2 x 2 x 1 1/2	2.375 x 2.375 x 1.900	3.25	3.25*	2.6	5 x 5 x 3	5.563 x 5.563 x 3.500	5.50	5.50*	12.6
50 x 50 x 40	60.3 x 60.3 x 48.3	83	83	1.2	125 x 125 x 80	141.3 x 141.3 x 88.9	140	140	5.7
2 1/2 x 2 1/2 x 1	2.875 x 2.875 x 1.315	3.75	3.75	3.7	5 x 5 x 4	5.563 x 5.563 x 4.500	5.50	5.50*	13.6
65 x 65 x 25	73.0 x 73.0 x 33.4	95	95	1.7	125 x 125 x 100	141.3 x 141.3 x 114.3	140	140	6.2
2 1/2 x 2 1/2 x 1 1/4	2.875 x 2.875 x 1.660	3.75	3.75	3.7	165.1 mm x 165.1 mm	6.500 x 6.500 x 2.375	6.50	6.50*	17.6
65 x 65 x 32	73.0 x 73.0 x 42.2	95	95	1.7	x 50	165.1 x 165.1 x 60.3	165	165	8.0
2 1/2 x 2 1/2 x 1 1/2	2.875 x 2.875 x 1.900	3.75	3.75	4.0	165.1 mm x 165.1 mm	6.500 x 6.500 x 3.000	6.50	6.50*	18.7
65 x 65 x 40	73.0 x 73.0 x 48.3	95	95	1.8	x 76.1 mm	165.1 x 165.1 x 76.1	165	165	8.5
2 1/2 x 2 1/2 x 2	2.875 x 2.875 x 2.375	3.75	3.75	4.4	165.1 mm x 165.1 mm	6.500 x 6.500 x 3.500	6.50	6.50*	20.2
65 x 65 x 50	73.0 x 73.0 x 60.3	95	95	2.0	x 80	165.1 x 165.1 x 88.9	165	165	9.2
76.1 mm x 76.1 mm	3.000 x 3.000 x 1.315	3.75	3.75	3.7	165.1 mm x 165.1 mm	6.500 x 6.500 x 4.500	6.50	6.50*	19.4
x 25	76.1 x 76.1 x 33.4	95	95	1.7	x 100	165.1 x 165.1 x 114.3	165	165	8.8
76.1 mm x 76.1 mm	3.000 x 3.000 x 1.660	3.75	3.75	4.4	6 x 6 x 2	6.625 x 6.625 x 2.375	6.50	6.50	17.6
x 32	76.1 x 76.1 x 42.2	95	95	2.0	150 x 150 x 50	168.3 x 168.3 x 60.3	165	165	8.0
76.1 mm x 76.1 mm	3.000 x 3.000 x 1.900	3.75	3.75	4.2	6 x 6 x 2 1/2	6.625 x 6.625 x 2.875	6.50	6.50*	18.7
x 40	76.1 x 76.1 x 48.3	95	95	1.9	150 x 150 x 65	168.3 x 168.3 x 73.0	165	165	8.5
76.1 mm x 76.1 mm	3.000 x 3.000 x 2.375	3.75	3.75*	4.4	6 x 6 x 3	6.625 x 6.625 x 3.500	6.50	6.50	20.2
x 50	76.1 x 76.1 x 60.3	95	95	2.0	150 x 150 x 80	168.3 x 168.3 x 88.9	165	165	9.2
3 x 3 x 1	3.500 x 3.500 x 1.315	4.25	4.25*	5.5	6 x 6 x 4	6.625 x 6.625 x 4.500	6.50	6.50*	19.4
80 x 80 x 25	88.9 x 88.9 x 33.4	108	108	2.5	150 x 150 x 100	168.3 x 168.3 x 114.3	165	165	8.8
3 x 3 x 1 1/4	3.500 x 3.500 x 1.660	4.25	4.25*	5.2	8 x 8 x 2	8.625 x 8.625 x 2.375	7.75	7.75	32.5
80 x 80 x 32	88.9 x 88.9 x 42.2	108	108	2.4	200 x 200 x 50	219.1 x 219.1 x 60.3	197	197	14.8
3 x 3 x 1 1/2	3.500 x 3.500 x 1.900	4.25	4.25	5.2	8 x 8 x 2 1/2	8.625 x 8.625 x 2.875	7.75	—	31.9
80 x 80 x 40	88.9 x 88.9 x 48.3	108	108	2.4	200 x 200 x 65	219.1 x 219.1 x 73.0	197	—	14.5
3 x 3 x 2	3.500 x 3.500 x 2.375	4.25	4.25	6.2	8 x 8 x 3	8.625 x 8.625 x 3.500	7.75	7.75	34.2
80 x 80 x 50	88.9 x 88.9 x 60.3	108	108	2.8	200 x 200 x 80	219.1 x 219.1 x 88.9	197	197	15.5
3 x 3 x 2 1/2	3.500 x 3.500 x 2.875	4.25	4.25	6.2	8 x 8 x 4	8.625 x 8.625 x 4.500	7.75	7.75	44.0
80 x 80 x 65	88.9 x 88.9 x 73.0	108	108	2.8	200 x 200 x 100	219.1 x 219.1 x 114.3	197	197	20.0
80 x 80	3.500 x 3.500 x 3.000	4.25	4.25*	6.2	8 x 8 x 6	8.625 x 8.625 x 6.625	7.75	—	46.2
x 76.1 mm	88.9 x 88.9 x 76.1	108	108	2.8	200 x 200 x 150	219.1 x 219.1 x 168.3	197	—	21.0
4 x 4 x 1	4.500 x 4.500 x 1.315	5.00	5.00	8.9	10 x 10 x 4	10.750 x 10.750 x 4.500	9.00	9.00*	62.8
100 x 100 x 25	114.3 x 114.3 x 33.4	127	127	4.0	250 x 250 x 100	273.0 x 273.0 x 114.3	229	229	28.5
4 x 4 x 1 1/2	4.500 x 4.500 x 1.900	5.00	5.00	9.3	10 x 10 x 6	10.750 x 10.750 x 6.625	9.00	—	66.0
100 x 100 x 40	114.3 x 114.3 x 48.3	127	127	4.2	250 x 250 x 150	273.0 x 273.0 x 168.3	229	—	30.0
4 x 4 x 2	4.500 x 4.500 x 2.375	5.00	5.00	8.8	10 x 10 x 8	10.750 x 10.750 x 8.625	9.00	—	69.3
100 x 100 x 50	114.3 x 114.3 x 60.3	127	127	4.0	250 x 250 x 200	273.0 x 273.0 x 219.1	229	—	31.5
4 x 4 x 2 1/2	4.500 x 4.500 x 2.875	5.00	5.00	9.5	12 x 12 x 3	12.750 x 12.750 x 3.500	10.00	10.00*	88.1
100 x 100 x 65	114.3 x 114.3 x 73.0	127	127	4.3	300 x 300 x 80	323.9 x 323.9 x 88.9	254	254	40.0
100 x 100	4.500 x 4.500 x 3.000	5.00	5.00*	9.5	12 x 12 x 4	12.750 x 12.750 x 4.500	10.00	10.00*	90.4
x 76.1 mm	114.3 x 114.3 x 76.1	127	127	4.3	300 x 300 x 100	323.9 x 323.9 x 114.3	254	254	41.0
4 x 4 x 3	4.500 x 4.500 x 3.500	5.00	5.00	9.4	12 x 12 x 6	12.750 x 12.750 x 6.625	10.00	—	83.6
100 x 100 x 80	114.3 x 114.3 x 88.9	127	127	4.3	300 x 300 x 150	323.9 x 323.9 x 168.3	254	—	38.0
139.7 mm x 139.7 mm	5.500 x 5.500 x 2.375	5.50	5.50*	12.4	12 x 12 x 8	12.750 x 12.750 x 8.625	10.00	—	83.6
x 50	139.7 x 139.7 x 60.3	140	140	5.6	300 x 300 x 200	323.9 x 323.9 x 219.1	254	—	38.0
139.7 mm x 139.7 mm	5.500 x 5.500 x 2.875	5.50	5.50*	12.8	12 x 12 x 10	12.750 x 12.750 x 10.750	10.00	—	88.0
x 65	139.7 x 139.7 x 73.0	140	140	5.8	300 x 300 x 250	323.9 x 323.9 x 273.0	254	—	40.0
5 x 5 x 2	5.563 x 5.563 x 2.375	5.50	5.50*	12.4					
125 x 125 x 50	141.3 x 141.3 x 60.3	140	140	5.6					

*Non-standard/stock items may require longer lead time.

7121 Reducing Tee

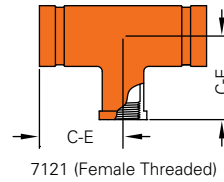

Nominal Size	Pipe O.D.	Female Threaded Branch		Nominal Size	Pipe O.D.	Female Threaded Branch	
		C - E	Weight			C - E	Weight
in	in	in	Lbs	in	in	in	Lbs
mm	mm	mm	Kgs	mm	mm	mm	Kgs
2 x 2 x 1¼	2.375 x 2.375 x 1.660	3.25	2.9	3 x 3 x 1¼	3.500 x 3.500 x 1.660	4.25	5.1
50 x 50 x 32	60.3 x 60.3 x 42.2	83	1.3	80 x 80 x 32	88.9 x 88.9 x 42.2	108	2.3
2 x 2 x 1½	2.375 x 2.375 x 1.900	3.25	4.0	3 x 3 x 1½	3.500 x 3.500 x 1.900	4.25	6.0
50 x 50 x 40	60.3 x 60.3 x 48.3	83	1.8	80 x 80 x 40	88.9 x 88.9 x 48.3	108	2.7
2½ x 2½ x 1	2.875 x 2.875 x 1.315	3.75	4.0	3 x 3 x 2	3.500 x 3.500 x 2.375	4.25	6.2
65 x 65 x 25	73.0 x 73.0 x 33.4	95	1.8	80 x 80 x 50	88.9 x 88.9 x 60.3	108	2.8
2½ x 2½ x 1¼	2.875 x 2.875 x 1.660	3.75	3.7	3 x 3 x 2½	3.500 x 3.500 x 2.875	4.25	7.3
65 x 65 x 32	73.0 x 73.0 x 42.2	95	1.7	80 x 80 x 65	88.9 x 88.9 x 73.0	108	3.3
2½ x 2½ x 1½	2.875 x 2.875 x 1.900	3.75	4.4	4 x 4 x 1½	4.500 x 4.500 x 1.900	5.00	9.3
65 x 65 x 40	73.0 x 73.0 x 48.3	95	2.0	100 x 100 x 40	114.3 x 114.3 x 48.3	127	4.2
2½ x 2½ x 2	2.875 x 2.875 x 2.375	3.75	4.6	4 x 4 x 2	4.500 x 4.500 x 2.375	5.00	9.3
65 x 65 x 50	73.0 x 73.0 x 60.3	95	2.1	100 x 100 x 50	114.3 x 114.3 x 60.3	127	4.2
76.1 mm x 76.1 mm x 25	3.000 x 3.000 x 1.315	3.75	4.4	4 x 4 x 2½*	4.500 x 4.500 x 2.875	5.00	10.8
	76.1 x 76.1 x 33.4	95	2.0	100 x 100 x 65	114.3 x 114.3 x 73.0	127	4.9
76.1 mm x 76.1 mm x 32	3.000 x 3.000 x 1.660	3.75	4.4	100 x 100 x 76.1 mm	4.500 x 4.500 x 3.000	5.00	9.9
	76.1 x 76.1 x 42.2	95	2.0		114.3 x 114.3 x 76.1	127	4.5
76.1 mm x 76.1 mm x 40	3.000 x 3.000 x 1.900	3.75	4.0	139.7 mm x 139.7 mm x 50	5.500 x 5.500 x 2.375	5.50	11.9
	76.1 x 76.1 x 48.3	95	1.8		139.7 x 139.7 x 60.3	140	5.4
76.1 mm x 76.1 mm x 50	3.000 x 3.000 x 2.375	3.75	4.9	5 x 5 x 2	5.563 x 5.563 x 2.375	5.50	12.3
	76.1 x 76.1 x 60.3	95	2.2	125 x 125 x 50	141.3 x 141.3 x 60.3	140	5.6
3 x 3 x ½	3.500 x 3.500 x 0.840	4.25	5.1	165.1 mm x 165.1 mm x 50	6.500 x 6.500 x 2.375	6.50	17.6
80 x 80 x 15	88.9 x 88.9 x 21.3	108	2.3		165.1 x 165.1 x 60.3	165	8.0
3 x 3 x ¾	3.500 x 3.500 x 1.050	4.25	5.1	6 x 6 x 2	6.625 x 6.625 x 2.375	6.50	20.5
80 x 80 x 20	88.9 x 88.9 x 26.7	108	2.3	150 x 150 x 50	168.3 x 168.3 x 60.3	165	9.3
3 x 3 x 1	3.500 x 3.500 x 1.315	4.25	5.1	6 x 6 x 2½	6.625 x 6.625 x 2.875	6.50	15.7
80 x 80 x 25	88.9 x 88.9 x 33.4	108	2.3	150 x 150 x 65	168.3 x 168.3 x 73.0	165	7.1

*Non-standard/stock items may require longer lead time.

Model

7150 Concentric Reducer

7151 Eccentric Reducer

Shurjoint ductile iron grooved-end fittings are made of ductile iron per ASTM A536 Gr. 65-45-12 and or ASTM A395 Gr. 65-45-15. E-E dimensions are manufacturer's standard. See page 74 for wrought steel grooved-end fittings.



7150



7151

Nominal Size	Pipe O.D.	#7150 Conc. Reducer		#7151 Ecc. Reducer		Nominal Size	Pipe O.D.	#7150 Conc. Reducer		#7151 Ecc. Reducer	
		E - E	Weight	E - E	Weight			E - E	Weight	E - E	Weight
in	in	in	Lbs	in	Lbs	in	in	in	Lbs	in	Lbs
mm	mm	mm	Kgs	mm	Kgs	mm	mm	mm	Kgs	mm	Kgs
1 1/4 x 1	1.660 x 1.315	2.50	0.4	--	--	4 x 3	4.500 x 3.500	3.00	2.2	4.00	2.9
32 x 25	42.2 x 33.4	64	0.2	--	--	100 x 80	114.3 x 88.9	76	1.0	102	1.3
1 1/2 x 1	1.900 x 1.315	2.50	0.5	--	--	5 x 4	5.563 x 4.500	3.50	3.6	4.00	6.2
40 x 25	48.3 x 33.4	64	0.2	--	--	125 x 100	141.3 x 114.3	89	1.6	102	2.8
1 1/2 x 1 1/4	1.900 x 1.660	2.50	0.6	--	--	6 x 2	6.625 x 2.375	4.00	4.2	4.00	4.4
40 x 32	48.3 x 42.2	64	0.3	--	--	150 x 50	168.3 x 60.3	102	1.9	102	2.0
2 x 1	2.375 x 1.315	2.50*	0.9	--	--	6 x 2 1/2	6.625 x 2.875	4.00	4.4	--	--
50 x 25	60.3 x 33.4	64	0.4	--	--	150 x 65	168.3 x 73.0	102	2.0	--	--
2 x 1 1/4	2.375 x 1.660	2.50	0.7	--	--	6 x 3	6.625 x 3.500	4.00	4.4	4.00	7.8
50 x 32	60.3 x 42.2	64	0.3	--	--	150 x 80	168.3 x 88.9	102	2.0	102	3.5
2 x 1 1/2	2.375 x 1.900	2.50	0.8	--	--	6 x 4	6.625 x 4.500	4.00	4.6	4.00	5.8
50 x 40	60.3 x 48.3	64	0.4	--	--	150 x 100	168.3 x 114.3	102	2.1	102	2.7
2 1/2 x 1 1/4	2.875 x 1.660	2.50	1.1	--	--	6 x 5	6.625 x 5.563	4.00	5.5	4.00	9.9
65 x 32	60.3 x 42.2	64	0.5	--	--	150 x 125	168.3 x 141.3	102	2.5	102	4.5
2 1/2 x 1 1/2	2.875 x 1.900	2.50	1.1	--	--	165.1 mm	6.500 x 2.375	4.00	4.2	4.00	4.4
65 x 40	60.3 x 48.3	64	0.5	--	--	x 50	165.1 x 60.3	102	1.9	102	2.0
2 1/2 x 2	2.875 x 2.375	2.50	1.1	3.50	1.4	165.1 mm	6.500 x 3.000	4.00	4.2	--	--
65 x 50	73.0 x 60.3	64	0.5	89	0.7	x 76.1 mm	165.3 x 76.1	102	1.9	--	--
76.1 mm	3.000 x 1.660	2.50	1.1	--	--	165.1 mm	6.500 x 3.500	4.00	4.4	4.00	7.7
x 32	76.1 x 42.2	64	0.5	--	--	x 80	165.1 x 88.9	102	2.0	102	3.5
76.1 mm	3.000 x 1.900	2.50	1.1	--	--	165.1 mm	6.500 x 4.500	4.00	4.6	4.00	5.8
x 40	76.1 x 48.3	64	0.5	--	--	x 100	165.1 x 114.3	102	2.1	102	2.7
76.1 mm	3.000 x 2.375	2.50	1.1	3.50	1.6	165.1 mm	6.500 x 5.500	4.00	5.5	4.00	9.9
x 50	76.1 x 60.3	64	0.5	89	0.7	x 139.7 mm	165.1 x 139.7	102	2.5	102	4.5
3 x 1	3.500 x 1.315	2.50	1.3	--	--	8 x 3	8.625 x 3.500	5.00	9.5	--	--
80 x 25	88.9 x 33.4	64	0.6	--	--	200 x 80	219.1 x 88.9	127	4.3	--	--
3 x 1 1/4	3.500 x 1.660	2.50	1.3	--	--	8 x 4	8.625 x 4.500	5.00	11.2	5.00	14.6
80 x 32	88.9 x 42.2	64	0.6	--	--	200 x 100	219.1 x 114.3	127	5.1	127	6.6
3 x 1 1/2	3.500 x 1.900	2.50	1.3	--	--	8 x 6	8.625 x 6.625	5.00	11.4	5.00	12.0
80 x 40	88.9 x 48.3	64	0.6	--	--	200 x 150	219.1 x 168.3	127	5.2	127	5.5
3 x 2	3.500 x 2.375	2.50	1.3	3.50	2.2	10 x 4	10.750 x 4.500	6.00	19.8	6.00	26.4
80 x 50	88.9 x 60.3	64	0.6	89	1.0	250 x 100	273.0 x 114.3	152	9.0	152	12.0
3 x 2 1/2	3.500 x 2.875	2.50	1.3	3.50	2.2	10 x 6	10.750 x 6.625	6.00	19.8	6.00	25.3
80 x 65	88.9 x 73.0	64	0.6	89	1.0	250 x 150	273.0 x 168.3	152	9.0	152	11.5
80	3.500 x 3.000	2.50	1.3	3.50	2.2	10 x 8	10.750 x 8.625	6.00	20.9	7.00	26.8
x 76.1 mm	88.9 x 76.1	64	0.6	89	1.0	250 x 200	273.0 x 219.1	152	9.5	178	12.2
4 x 2	4.500 x 2.375	3.00	2.0	4.00	2.8	12 x 6	12.750 x 6.625	7.00	30.9	7.00	39.7
100 x 50	114.3 x 60.3	76	0.9	102	1.3	300 x 150	323.9 x 168.3	178	14.0	178	18.0
4 x 2 1/2	4.500 x 2.875	3.00	2.2	4.00	3.3	12 x 8	12.750 x 8.625	7.00	30.9	7.00	40.8
100 x 65	114.3 x 73.0	76	1.0	102	1.5	300 x 200	323.9 x 219.1	178	14.0	178	18.5
100	4.500 x 3.000	3.00	2.3	4.00	3.3	12 x 10	12.750 x 10.750	7.00	30.1	7.00	44.1
x 76.1 mm	114.3 x 76.1	76	1.0	102	1.5	300 x 250	323.9 x 273.0	178	13.7	178	20.0

*Non-standard/stock items may require longer lead time.

Model 7160 End Cap

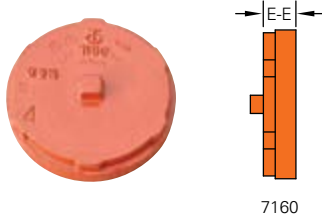

7160

Nominal Size	Pipe O.D.	#7160 End Cap	
		E - E	Weight
in	in	in	Lbs
mm	mm	mm	Kgs
1	1.315	0.87	0.2
25	33.4	22	0.1
1¼	1.660	1.00	0.3
32	42.2	25	0.2
1½	1.900	1.00	0.4
40	48.3	25	0.2
2	2.375	1.00	0.7
50	60.3	25	0.3
2½	2.875	1.00	0.9
65	73.0	25	0.4
76.1 mm	3.000	1.00	0.9
	76.1	25	0.4
3	3.500	1.00	1.5
80	88.9	25	0.7
108.0 mm	4.250	1.00	2.4
	108.0	25	1.1
4	4.500	1.00	2.2
100	114.3	25	1.0
133.0 mm	5.250	1.00	3.7
	133.0	25	1.7
139.7 mm	5.500	1.00	3.7
	139.7	25	1.7
5	5.563	1.00	3.7
125	141.3	25	1.7
159.0 mm	6.250	1.00	5.1
	159.0	25	2.3
165.1 mm	6.500	1.00	6.0
	165.1	25	2.7
6	6.625	1.00	6.0
150	168.3	25	2.7
8	8.625	1.18	10.1
200	219.1	30	4.6
10	10.750	1.25	15.4
250	273.0	32	7.0
12	12.750	1.25	22.0
300	323.9	32	10.0

Model 7160P End Cap with Plug



Nominal Size	Pipe O.D.	7160P Plug Size
		in
in	in	in
mm	mm	mm
1	1.315	—
25	33.4	—
1¼	1.660	—
32	42.2	—
1½	1.900	—
40	48.3	—
2	2.375	½
50	60.3	15
2½	2.875	½
65	73.0	15
76.1 mm	3.000	½
	76.1	15
3	3.500	½
80	88.9	15
108.0 mm	4.250	—
	108.0	—
4	4.500	1
100	114.3	25
133.0 mm	5.250	—
	133.0	—
139.7 mm	5.500	1
	139.7	25
5	5.563	1
125	141.3	25
159.0 mm	6.250	—
	159.0	—
165.1 mm	6.500	1
	165.1	25
6	6.625	1
150	168.3	25
8	8.625	1½
200	219.1	40
10	10.750	1½
250	273.0	40
12	12.750	1½
300	323.9	40
200 JIS	8.516	—
	216.3	—
250 JIS	10.528	—
	267.4	—
300 JIS	12.539	—
	318.5	—

Model 7160T Transition Cap

The Shurjoint Model 7160T is an ideal transition fitting when a large reduction is required and can be used in place of more costly reducers or swaged nipples. In addition the 7160T can serve as a drain fitting.

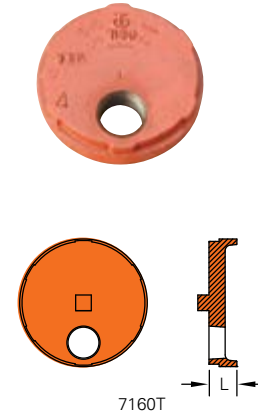

7160T

Nominal Size	NPT / BSP	L	Weight	
			Lbs	
in	in	in	Kgs	
mm	mm	mm		
2 x	½	0.94	0.55	
	15	23.8	0.25	
50 x	¾	0.94	0.55	
	20	23.8	0.25	
2½ x	1	0.94	0.97	
	25	23.8	0.44	
	1¼	0.94	0.77	
	32	23.8	0.35	
65 x	1½	0.94	0.70	
	40	23.8	0.30	
	3 x	1	1.00	1.43
		25	25.4	0.65
1¼		1.00	1.43	
32		25.4	0.65	
80 x	1½	1.00	1.30	
	40	25.4	0.60	
	2	1.00	1.33	
	50	25.4	0.60	
4 x	1	1.00	2.09	
	25	25.4	0.95	
	1¼	1.00	2.09	
	32	25.4	0.95	
	1½	1.00	2.09	
	40	25.4	0.95	
6 x	2	1.00	2.09	
	50	25.4	0.95	
	150 x	1	1.00	5.52
		25	25.4	2.50
		1¼	1.00	5.52
		32	25.4	2.50
1½		1.00	5.52	
40		25.4	2.50	
2	1.00	5.52		
	50	25.4	2.50	

Model 7160H Domed End Cap

The Shurjoint Model 7160H end caps are cast of ductile iron and are designed to withstand pressure evenly over the entire spherical surface. The Model 7160H End Cap is designed for use on 10" - 24" mechanical piping applications.

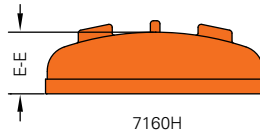

Nominal Size	Pipe O.D.	#7160H Domed End Cap	
		E - E	Weight
in	in	in	Lbs
mm	mm	mm	Kgs
10	10.750	3.00	12.1
250	273.0	76.1	5.5
12	12.750	3.00	16.3
300	323.9	76.1	7.4
14	14.000	4.00	26.4
350	355.6	102.0	12.0
16	16.000	4.00	32.0
400	406.4	102.0	14.5
18	18.000	5.00	39.2
450	457.2	127.0	17.8
20	20.000	6.00	53.9
500	508.0	152.0	24.5
24	24.000	6.00	75.9
600	609.6	152.0	34.5

Model 7110LR 1.5D 90° Elbow 7111LR 1.5D 45° Elbow 7137 True-Y

Shurjoint ductile iron grooved-end fittings are made of ductile iron per ASTM A536 Gr. 65-45-12 and or ASTM A395 Gr. 65-45-15. C-E dimensions are manufacturer's standard. See page 72 for wrought steel grooved-end fittings.

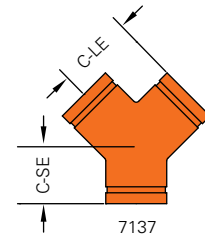
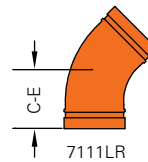
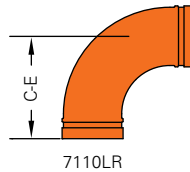

Nominal Size	Pipe O.D.	#7110LR 1.5D LR 90° Elbow		#7111LR 1.5D LR 45° Elbow		#7137 True-Y		
		C - E	Weight	C - E	Weight	C - LE	C - SE	Weight
in	in	in	Lbs	in	Lbs	in	in	Lbs
mm	mm	mm	Kgs	mm	Kgs	mm	mm	Kgs
2	2.375	4.38	2.4	2.75	1.8	3.25	2.75	2.5
50	60.3	111	1.1	70	0.8	83	70	1.1
2½	2.875	5.00	4.0	3.00	3.1	3.75	3.00	3.8
65	73.0	127	1.8	76	1.4	95	76	1.7
76.1 mm	3.000	5.00	4.0	3.00	3.2	3.75	3.00	4.0
	76.1	127	1.8	76	1.5	95	76	1.8
3	3.500	5.88	5.8	3.38	4.0	4.25	3.25	5.5
80	88.9	149	2.6	86	1.8	108	83	2.5
4	4.500	7.50	10.3	4.00	7.7	5.00	3.75	10.4
100	114.3	191	4.7	102	3.5	127	95	4.7
139.7 mm	5.500	9.50	18.1	5.00	10.1	5.50	4.00	15.0
	139.7	241	8.2	127	4.6	140	102	6.8
5	5.563	9.50	18.1	5.00	10.1	5.50	4.00	11.6
125	141.3	241	8.2	127	4.6	140	102	5.3
165.1 mm	6.500	10.75	25.3	5.50	18.0	6.50	4.50	19.6
	165.1	273	11.5	140	8.2	165	114	8.9
6	6.625	10.75	25.3	5.50	18.0	6.50	4.50	19.6
150	168.3	273	11.5	140	8.2	165	114	8.9
8	8.625	14.25	50.7	7.25	35.3	7.75	6.00	34.3
200	219.1	362	23.0	184	16.0	197	152	15.6
10	10.750	17.25	73.0	8.50	78.6	9.00*	6.50	56.2
250	273.0	438	42.2	216	36.1	229	165	25.5
12	12.750	20.50	157.6	10.00	73.9	10.00*	7.00	79.4
300	323.9	521	71.5	254	33.5	254	178	36.0

*Non-standard/stock items may require longer lead time.

Model

7112G Goose Neck 22½° Elbow

Two Shurjoint Model 7112G elbows in combination with a coupling will serve as a universal joint and is ideal for instances where a pipe line is in need of a slight adjustment during make-up.

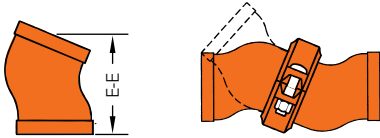

Nominal Size	Pipe O.D.	7112G 22½° Elbows	
		E - E	Weight
in	in	in	Lbs
mm	mm	mm	Kgs
1½	1.900	3.75	1.3
40	48.3	95 G	0.6
2	2.375	3.75	1.3
50	60.3	95 G	0.8
2½	2.875	4.00	2.2
65	73.0	102 G	1.0
76.1 mm	3.000	4.00	2.2
	76.1	102 G	1.0
3	3.500	4.50	3.1
80	88.9	114 G	1.4
4	4.500	5.00	4.4
100	114.3	127 G	2.0
139.7 mm	5.500	5.00	6.5
	139.7	127 G	2.9
5	5.563	5.00	6.8
125	141.3	127 G	3.0
165.1 mm	6.500	6.25	11.0
	165.1	159 G	5.0
6	6.625	6.25	11.0
150	168.3	159 G	5.0
8	8.625	7.75	22.0
200	219.1	197 G	10.0
200 JIS	8.516	7.75	19.2
	216.3	197 G	8.8

Model

7110-B 90° Elbow with Base Support

The Shurjoint Model 7110-B is a ductile iron 90° grooved-end elbow with base support, designed for installation at the bottom of a

riser system. An anchor can be placed in conjunction with the base to support the weight of the pipe, coupling and fluid.

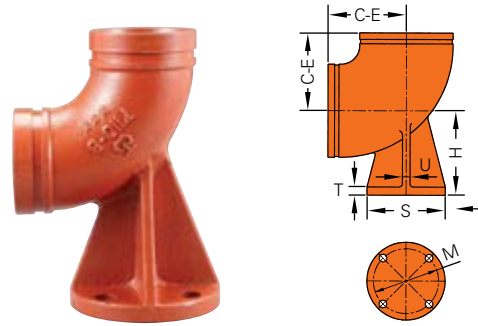

Nominal Size	Pipe O.D.	Dimensions						Weight
		C - E	H	U	T	S	M	
in	in	in	in	in	in	in	in	Lbs
mm	mm	mm	mm	mm	mm	mm	mm	Kgs
3	3.500	4.25	4.88	0.50	0.56	5.00	3.88	10.5
80	88.9	108	124	13	14	127	99	4.8
4	4.500	5.00	5.50	0.50	0.62	6.00	4.75	15.2
100	114.3	127	140	13	16	152	121	6.9
6	6.625	6.50	7.00	0.62	0.69	7.00	5.50	26.3
150	168.3	165	178	16	18	178	140	11.9
8	8.625	7.76	8.38	0.88	0.94	9.00	7.50	56.9
200	219.1	197	213	22	24	229	191	25.8
10	10.750	9.02	9.75	0.88	0.94	9.00	7.50	88.9
250	273.0	229	248	22	24	229	191	40.3

Model

901 90° SR Elbow 903 SR Tee

Shurjoint short radius fittings, while primarily designed for fire protection applications, can also be used for general service requirements.

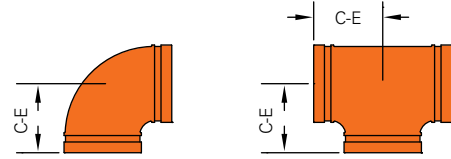

Nominal Pipe Size	Pipe O.D.	#901 SR 90° Elbow		#903 SR Straight Tee	
		C - E	Weight	C - E	Weight
in	in	in	Lbs	in	Lbs
mm	mm	mm	Kgs	mm	Kgs
2	2.375	2.75	1.5	2.75	2.2
50	60.3	70	0.7	70	1.0
2½	2.875	3.00	2.0	3.00	2.9
65	73.0	76	0.9	76	1.3
76.1 mm	3.000	3.00	2.5	3.00	2.9
	76.1	76	1.1	76	1.3
3	3.500	3.38	3.1	3.38	4.4
80	88.9	86	1.4	86	2.0
4	4.500	4.00	4.9	4.00	7.9
100	114.3	102	2.2	102	3.6
139.7 mm	5.500	4.88	7.9	4.88	11.1
	139.7	124	3.6	124	5.1
5	5.563	4.88	7.9	4.88	10.1
125	141.3	124	3.6	124	4.6
165.1 mm	6.500	5.50	12.9	5.50	16.5
	165.1	140	5.9	140	7.5
6	6.625	5.50	12.9	5.50	17.2
150	168.3	140	5.9	140	7.8
8	8.625	6.94	23.4	6.94	36.3
200	219.1	176	10.6	176	16.5

Model

7110DR Drain Elbow

The Shurjoint Model 7110DR is a grooved-end ductile iron cast elbow with an integral 1" NPT or BSP drain. The 7110DR is designed for use in fire protection and general service applications.

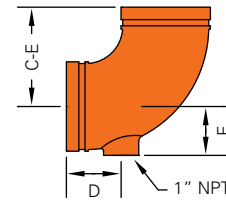

Nominal Pipe Size	Pipe O.D.	Dimensions			Weight
		C - E	D	E	
in	in	in	in	in	Lbs
mm	mm	mm	mm	mm	Kgs
2	2.375	3.27	2.25	1.57	2.2
50	60.3	83	57	40	1.0
2½	2.875	3.75	2.75	1.57	2.8
65	73.0	95	70	40	1.3
76.1mm*	3.000	3.75	2.75	1.57	2.8
	76.1	95	70	40	1.3
3	3.500	4.25	2.75	1.93	4.6
80	88.9	108	70	49	2.1
4	4.500	5.00	2.75	2.48	6.6
100	114.3	127	70	63	3.0
165.1mm*	6.500	6.50	2.75	3.54	13.4
	165.1	165	70	90	6.1
6	6.625	6.50	2.75	3.54	13.4
150	168.3	165	70	90	6.1
8	8.625	7.76	3.27	4.49	25.6
200	219.1	197	83	114	11.6

*Non-standard/stock items may require longer lead time.

Model

7127 Standpipe Tee

The Shurjoint Model 7127 is a grooved-end tee with a 2½" NPT/BSP threaded branch, specially designed for use on fire protection standpipes.

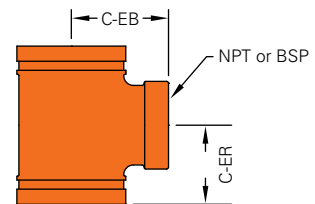

Nominal Size	Pipe O.D.	Dimensions		Weight
		C - ER	C - EB	
in	in	in	in	Lbs
mm	mm	mm	mm	Kgs
4 x 4 x 2½	4.500 x 4.500 x 2.875	3.25	4.00	5.84
100 x 100 x 65	114.3 x 114.3 x 73.0	83	102	2.65
6 x 6 x 2½	6.625 x 6.625 x 2.875	3.25	5.00	9.48
150 x 150 x 65	168.3 x 168.3 x 73.0	83	127	4.30

Model 7125 Bullhead Tee

The Shurjoint Model 7125 is a grooved-end bullhead tee, specifically designed for use on fire protection systems. The 7125 allows you to directly split the flow into two reduced branch lines without the need for concentric reducers and multiple couplings.

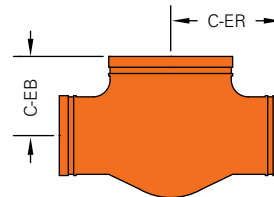

Fire Protection Applications

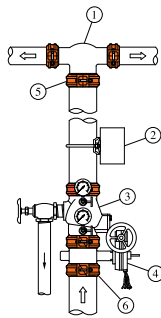

- ① 7125 Bullhead Tee
- ② Waterflow Indicator
- ③ RCV Riser Check Valve With Trim Kit
- ④ SJ-300F Butterfly Valve
- ⑤ 7707/7705 Flexible Couplings
- ⑥ Z07/7771 Rigid Couplings

Nominal Pipe Size	Pipe O.D.	Dimensions		Weight
		C - ER	C - EB	
in	in	in	in	Lbs
mm	mm	mm	mm	Kgs
2 x 2 x 2½	2.375 x 2.375 x 2.875	3.74	3.27	4.03
50 x 50 x 65	60.3 x 60.3 x 73.0	95	83	1.83
2 x 2 x 3	2.375 x 2.375 x 3.500	4.25	3.74	4.34
50 x 50 x 80	60.3 x 60.3 x 88.9	108	95	1.97
2 x 2 x 4	2.375 x 2.375 x 4.500	5.00	4.02	7.05
50 x 50 x 100	60.3 x 60.3 x 114.3	127	102	3.20
2½ x 2½ x 3	2.875 x 2.875 x 3.500	4.25	3.75	5.62
65 x 65 x 80	73.0 x 73.0 x 88.9	108	95	2.55
2½ x 2½ x 4	2.875 x 2.875 x 4.500	5.00	4.00	7.32
65 x 65 x 100	73.0 x 73.0 x 114.3	127	102	3.32
3 x 3 x 4	3.500 x 3.500 x 4.500	5.00	4.00	7.94
80 x 80 x 100	88.9 x 88.9 x 114.3	127	102	3.60
4 x 4 x 6	4.500 x 4.500 x 6.625	6.50	5.00	14.99
100 x 100 x 150	114.3 x 114.3 x 168.3	165	127	6.80
5 x 5 x 8	5.563 x 5.563 x 8.625	7.75	5.50	31.00
125 x 125 x 200	141.3 x 141.3 x 219.1	197	140	14.00
6 x 6 x 8	6.625 x 6.625 x 8.625	7.75	6.50	29.12
150 x 150 x 200	168.3 x 168.3 x 219.1	197	165	13.21

Model

7150F Reducing Socket (GR X FT) 7150M Reducing Nipple (GR X MT)

The Shurjoint Models 7150F & 7150M are designed for making a direct reduction from a grooved system to a female or male threaded system without the need for more costly swaged nipples or adapters.



7150F



7150M

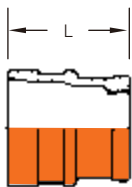

7150F

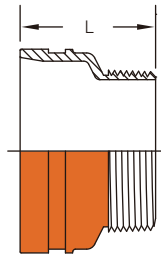

7150M

Nominal Size Gr. X Th.	Pipe O.D.	7150F		7150M	
		L	Weight	L	Weight
in	in	in	Lbs	in	Lbs
mm	mm	mm	Kgs	mm	Kgs
1½ x 1	1.900 x 1.315	2.5	0.60	2.5	0.53
40 x 25	48.3 x 33.4	63.5	0.27	63.5	0.24
2 x 1	2.375 x 1.315	2.5	0.92	2.5	0.88
50 x 25	60.3 x 33.4	63.5	0.42	63.5	0.40
2 x 1¼	2.375 x 1.660	2.5	1.01	2.5	0.70
50 x 32	60.3 x 42.2	63.5	0.46	63.5	0.32
2 x 1½	2.375 x 1.900	2.5	0.95	2.5	1.04
50 x 40	60.3 x 48.3	63.5	0.43	63.5	0.47
2½ x 1	2.875 x 1.315	2.5	1.21	2.5	0.88
65 x 25	73.0 x 33.4	63.5	0.55	63.5	0.40
76.1 mm x 25	3.000 x 1.315	2.5	1.21	2.5	1.64
	76.1 x 33.4	63.5	0.55	63.5	0.75
2½ x 1¼	2.875 x 1.660	2.5	1.17	2.5	1.59
65 x 32	73.0 x 42.2	63.5	0.53	63.5	0.72
76.1 mm x 32	3.000 x 1.660	2.5	1.17	2.5	1.59
	76.1 x 42.2	63.5	0.53	63.5	0.72
2½ x 1½	2.875 x 1.900	2.5	1.08	2.5	1.72
65 x 40	73.0 x 48.3	63.5	0.49	63.5	0.78
76.1 mm x 40	3.000 x 1.900	2.5	1.08	2.5	1.72
	76.1 x 48.3	63.5	0.49	63.5	0.78
2½ x 2	2.875 x 2.375	2.5	1.52	2.5	0.92
65 x 50	73.0 x 60.3	63.5	0.69	63.5	0.42
76.1 mm x 50	3.000 x 2.375	2.5	1.52	2.5	1.09
	76.1 x 60.3	63.5	0.69	63.5	0.49
3 x 1	3.500 x 1.315	2.5	1.91	2.5	1.25
80 x 25	88.9 x 33.4	63.5	0.87	63.5	0.57
3 x 1¼	3.500 x 1.660	2.5	1.50	2.5	1.67
80 x 32	88.9 x 42.2	63.5	0.68	63.5	0.76
3 x 1½	3.500 x 1.900	2.5	1.63	2.5	1.53
80 x 40	88.9 x 48.3	63.5	0.74	63.5	0.74
3 x 2	3.500 x 2.375	2.5	1.56	2.5	1.32
80 x 50	88.9 x 60.3	63.5	0.71	63.5	0.60
3 x 2½	3.500 x 2.875	2.5	2.20	2.5	2.20
80 x 65	88.9 x 73.0	63.5	1.00	63.5	1.00
80 x 76.1 mm	3.500 x 3.000	2.5	2.20	2.5*	2.20
	88.9 x 76.1	63.5	1.00	63.5	1.00
4 x 1¼	4.500 x 1.660	3	2.33	3	2.19
100 x 32	114.3 x 42.2	76.1	1.06	76.1	0.99
4 x 1½	4.500 x 1.900	3	2.05	3	2.05
100 x 40	114.3 x 48.3	76.1	0.93	76.1	0.93
4 x 2	4.500 x 2.375	3	2.29	3	2.31
100 x 50	114.3 x 60.3	76.1	1.03	76.1	1.05
4 x 2½	4.500 x 2.875	3	2.25	3	2.05
100 x 65	114.3 x 73.0	76.1	1.02	76.1	0.93
100 x 76.1 mm	4.500 x 3.000	3	2.25	3*	2.05
	114.3 x 76.1	76.1	1.02	76.1	0.93
5 x 1½	5.563 x 1.900	3.5*	3.94	3.5*	2.05
125 x 40	141.3 x 48.3	88.9	1.79	88.9	0.93
139.7 mm x 40	5.500 x 1.900	3.5*	3.94	3.5*	2.05
	139.7 x 48.3	88.9	1.79	88.9	0.93
6 x 1½	6.625 x 1.900	4	6.47	4	4.84
150 x 40	168.3 x 48.3	101.6	2.94	101.6	2.20
165.1 mm x 40	6.500 x 1.900	4	5.56	4	4.75
	165.1 x 48.3	101.6	2.52	101.6	2.15
6 x 2	6.625 x 2.375	4	5.28	4	4.91
150 x 50	168.3 x 60.3	101.6	2.40	101.6	2.23
165.1 mm x 50	6.500 x 2.375	4	5.28	4	4.91
	165.1 x 60.3	101.6	2.40	101.6	2.23
6 x 2½	6.625 x 2.875	4	5.46	4	4.91
150 x 65	168.3 x 73.0	101.6	2.48	101.6	2.23
165.1 mm	6.500 x 3.000	4*	4.40	4*	4.97
x 76.1 mm	165.1 x 76.1	101.6	2.00	101.6	2.26
6 x 4	6.625 x 4.500	4	6.37	4	4.52
150 x 100	168.3 x 114.3	101.6	2.89	101.6	2.10
165.1 mm x 100	6.500 x 4.500	4	4.52	4	4.52
	165.1 x 114.3	101.6	2.10	101.6	2.10

*Non-standard/stock items may require longer lead time.

Model 899 End-All Fitting

The Shurjoint Model 899 End-All fitting is a unique domed end cap fitting available with a ½", ¾" or 1" NPT or BSP threaded outlet. Designed as an end of line fitting, the End-All features two multi-function bosses which can be used for the direct connection of

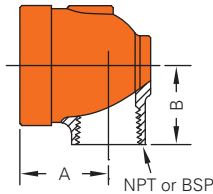

Model 55 Adapter Nipple (GR X MT)

The Shurjoint Model 55 is an integral cast adapter that allows for a direct transition from a grooved system to a male threaded system or component. For other sizes see page 69, Model 57, 58 & 59 nipples.

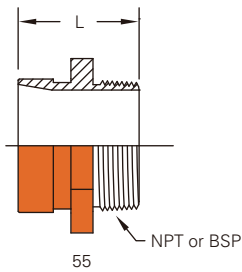

Nominal Size Grooved x Threaded in / mm	Pipe O.D. in / mm	L in / mm	Weight Lbs / Kgs
1½ x 1½M	1.900	2.50	0.77
40 x 40M	48.3	63.5	0.35
2 x 2M	2.375	2.50	0.90
50 x 50M	60.3	63.5	0.40

Nominal Size Grooved x Threaded	Dimensions		Weight
	A	B	
in	in	in	Lbs
mm	mm	mm	Kgs
1½ x ½	1.750	1.190	0.7
32 x 15	44.5	30.1	
1½ x ¾	1.750	1.190	0.3
32 x 20	44.5	30.1	
1½ x 1	1.900	1.250	0.9
32 x 25	48.3	31.8	
1½ x ½	1.750	1.313	0.4
40 x 15	44.5	33.3	
1½ x ¾	1.750	1.313	1.1
40 x 20	44.5	33.3	
1½ x 1	1.900	1.375	0.5
40 x 25	48.3	34.9	
2 x ½	1.750	1.562	1.1
50 x 15	44.5	39.7	
2 x ¾	1.750	1.562	0.5
50 x 20	44.5	39.7	
2 x 1	1.900	1.625	1.3
50 x 25	48.3	41.3	
2½ x ½	1.750	1.750	0.6
65 x 15	44.5	44.5	
2½ x ¾	1.750	1.750	1.3
65 x 20	44.5	44.5	
2½ x 1	1.900	1.813	0.6
65 x 25	48.3	46.0	

Model 56 Hose Nipple

The Shurjoint Model 56 hose nipple allows for a direct connection with rubber or plastic hoses.

Material: Ductile iron ASTM A536 Gr. 65-45-12 and or ASTM A395 Gr. 65-45-15.

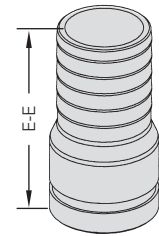

Nominal Size	Pipe O.D.	E-E	Weight
in	in	in	Lbs
mm	mm	mm	Kgs
1	1.315	3.3	0.4
25	33.4	83	0.2
1½	1.900	4.0	0.7
40	48.3	102	0.3
2	2.375	4.6	1.2
50	60.3	117	0.6
2½	2.875	5.5	2.2
65	73.0	140	1.0
3	3.500	6.0	3.3
80	88.9	152	1.5
4	4.500	7.25	5.5
100	114.3	184	2.5
5*	5.563	9.75	8.1
125	141.3	248	3.7
6	6.625	11.0	14.5
150	168.3	279	6.6
8	8.625	12.5	24.2
200	219.1	318	11.0
10*	10.750	14.0	29.0
250	273.0	356	13.2
12*	12.750	16.0	46.0
300	323.9	406	20.9

*Non-standard/stock items may require longer lead time.

Model

57 Nipple, Groove X Groove

58 Nipple, Groove X Bevel

59 Nipple, Groove X Thread

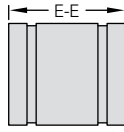

57
Gr. x Gr.

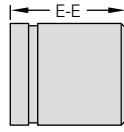

58
Gr. x Bev.

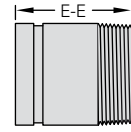

59
Gr. x Th

Nominal Pipe Size	Pipe O.D.	57 (Gr x Gr)		58 (Gr x Bev)		59 (Gr x Th)	
		E - E	Weight	E - E	Weight	E - E	Weight
in	in	in	Lbs	in	Lbs	in	Lbs
mm	mm	mm	Kgs	mm	Kgs	mm	Kgs
3/4	1.050	3	0.29	3	0.29	3	0.29
20	26.7	76	0.13	76	0.13	76	0.13
1	1.315	3	0.42	3	0.42	4	0.46
25	33.4	76	0.19	76	0.19	102	0.21
1 1/4	1.660	4	0.68	4	0.70	4	0.66
32	42.2	102	0.31	102	0.32	102	0.30
1 1/2	1.900	4	0.82	4	0.84	4	0.79
40	48.3	102	0.37	102	0.38	102	0.36
2	2.375	4	1.10	4	1.10	4	1.10
50	60.3	102	0.50	102	0.50	102	0.50
2 1/2	2.875	4	1.76	4	1.76	4	1.54
65	73.0	102	0.80	102	0.80	102	0.72
76.1 mm	3.000	4	1.98	4	1.98	4	1.98
	76.1	102	0.90	102	0.90	102	0.90
3	3.500	4	2.40	4	2.40	4	2.20
80	88.9	102	1.10	102	1.10	102	1.00
4	4.500	6	5.17	6	5.17	6	4.84
100	114.3	152	2.35	152	2.35	152	2.20
5	5.563	6	7.26	6	7.26	6	6.60
125	141.3	152	3.30	152	3.30	152	3.00
139.7 mm	5.500	6	7.26	6	7.26	6	6.60
	139.7	152	3.30	152	3.30	152	3.00
6	6.625	6	9.90	6	9.90	6	9.81
150	168.3	152	4.50	152	4.50	152	4.46
165.1 mm	6.500	6	9.46	6	9.46	6	9.81
	165.1	152	4.30	152	4.30	152	4.46
8	8.625	6	14.30	6	14.30	--	--
200	219.1	152	6.50	152	6.50	--	--
10	10.750	8	27.06	8	19.00	--	--
250	273.0	203	12.30	203	8.66	--	--
12	12.750	8	35.64	8	22.35	--	--
300	323.9	203	16.20	203	10.16	--	--
200 JIS	8.516	6	14.30	6	14.30	--	--
	216.3	152	6.50	152	6.50	--	--
250 JIS	10.528	8	27.06	8	19.00	--	--
	267.4	203	12.30	203	8.66	--	--
300 JIS	12.539	8	35.64	8	22.35	--	--
	318.5	203	16.20	203	10.16	--	--
14	14.000	8	36.38	8	36.38	--	--
350	355.6	203	16.50	203	16.50	--	--
16	16.000	8	41.67	8	41.67	--	--
400	406.4	203	18.90	203	18.90	--	--
18	18.000	8	47.19	8	47.19	--	--
450	457.0	203	21.40	203	21.40	--	--
20	20.000	8	52.48	8	52.48	--	--
500	508.0	203	23.80	203	23.80	--	--
24	24.000	8	63.28	8	63.28	--	--
600	610.0	203	28.70	203	28.70	--	--

* Note: Present dimensions and other information for the model 54 which is the groove by female.

Sprinkler Hubs

The Shurjoint Sprinkler Hubs are grooved-end manifold fittings with a number of threaded outlets to accommodate flexible sprinkler hoses. The Sprinkler Hubs can also be used in combination with flexible sprinkler hoses and traditional hard piping depending on your requirements. These fittings work as a hub for multiple flexible hoses and or hard pipe runs, thus reducing the number of headers, drop nipples and fittings required. All outlets are 1" NPT or BSPT. Maximum working pressure is 300 psi (20 Bar, 2.0 MPa) CWP. cULus listed and FM approved. The C-E dimensions conform to ANSI B16.3 Class 150.



Model 850 Sprinkler Hub 3 Outlets

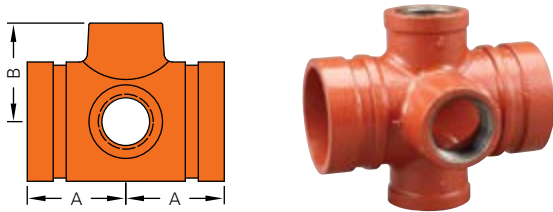

Size	A	B	Weight
in	in	in	Lbs
mm	mm	mm	Kgs
2 x 2 x 1 (3)	2.38	2.02	2.20
50 x 50 x 25 (3)	60	51	1.00
2½ x 2½ x 1 (3)	2.38	2.25	2.75
65 x 65 x 25 (3)	60	57	1.25

(): Number of outlets

Model 853 Sprinkler End Hub 4 Outlets

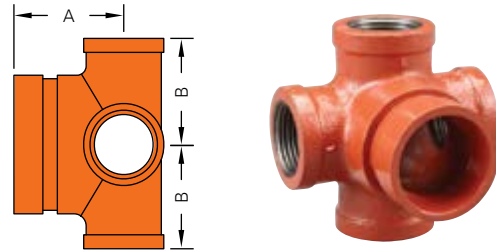

Size	A	B	Weight
in	in	in	Lbs
mm	mm	mm	Kgs
1½ x 1 (4)	2.38	1.80	1.76
40 x 25 (4)	60	46	0.8
2 x 1 (4)	2.38	2.02	2.20
50 x 25 (4)	60	51	1.00
2½ x 1 (4)	2.38	2.25	2.64
65 x 25 (4)	60	57	1.20

(): Number of outlets

Model 851 Reducing Sprinkler Hub 3 Outlets

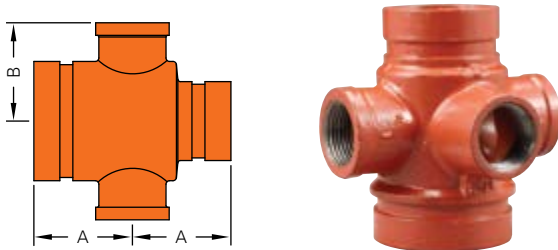

Size	A	B	Weight
in	in	in	Lbs
mm	mm	mm	Kgs
2 x 1½ x 1 (3)	2.38	2.02	2.20
50 x 40 x 25 (3)	60	51	1.00
2½ x 1½ x 1 (3)	2.38	2.25	2.65
65 x 40 x 25 (3)	60	57	1.20
2½ x 2 x 1 (3)	2.38	2.25	2.86
65 x 50 x 25 (3)	60	60	1.30

(): Number of outlets

Model 7114 Hydrant Elbow

The Shurjoint Model 7114 Hydrant Elbow is designed for use on fire protection systems. The small end of the elbow offers both a 2½" BSP threaded outlet as well as a 3" grooved connection. The boss can be factory tapped to 1" BSP on request.

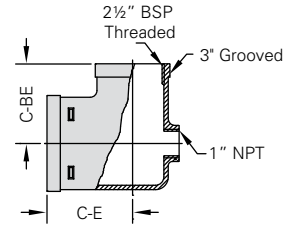

Nominal Pipe Size	Pipe O.D.	Dimensions		Weight
		C - E	C - BE	
in	in	in	in	Lbs
mm	mm	mm	mm	Kgs
4 x 3 x 1	4.500 x 3.500 x 1.315	4.00	3.75	5.95
100 x 80 x 25	114.3 x 88.9 x 33.4	102	95	2.70

Model 7122 Hydrant Tee

The Shurjoint Model 7122 Hydrant Tee is designed for use on fire protection systems. The 7122 tee offers both a 2½" BSP threaded and a 3" grooved outlet. The boss can be factory tapped to 1" BSP on request.

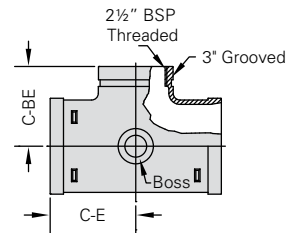

Nominal Pipe Size	Pipe O.D.	Dimensions		Weight
		C - E	C - BE	
in	in	in	in	Lbs
mm	mm	mm	mm	Kgs
4 x 4 x 3	4.500 x 4.500 x 3.500	4.00	4.00	7.72
100 x 100 x 80	114.3 x 114.3 x 88.9	102	102	3.50
165.1 mm x 165.1 mm x 80	6.500 x 6.500 x 3.500	5.13	5.13	12.21
	165.1 x 165.1 x 88.9	130	130	5.54

Model 7133 Pitcher Tee

The Shurjoint Model 7133 pitcher tee provides a quick and easy connection and transition from a grooved riser system to a threaded hydrant valve outlet. The pitcher tee is designed for 3", 4" and 6" steel pipe risers with a 2½" BSP threaded or 3" grooved hydrant connection outlet.

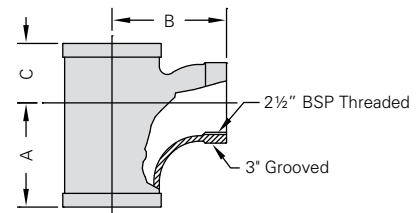

Nominal Pipe Size	Pip O.D.	Hydrant Outlet	Dimensions			Weight
			A	B	C	
in	in		in	in	in	Lbs
mm	mm		mm	mm	mm	Kgs
80 x 80 x 76.1mm	3.500 x 3.500 x 3.000	Taper	4.75	4.75	2.72	6.2
		BSP	121	121	69	2.8
100 x 100 x 76.1mm	4.500 x 4.500 x 3.000	Taper	4.75	5.25	2.72	7.5
		BSP	121	133	69	3.4

Wrought Grooved Fittings

Model

W110LR 90° Elbow
W120 Tee

W111LR 45° Elbow
W160 Cap

Shurjoint wrought steel grooved fittings are fabricated from standard weight (0.375" or 9.5 mm) carbon steel pipe to ASTM A234 Gr. WPB or equivalent, or segmentally welded with carbon steel of the same or equivalent grade. C-E dimensions conform to ANSI B16.9.

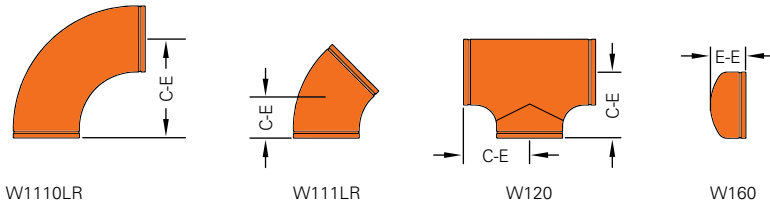

Nominal Size	Pipe O.D.	W110LR 90° L/R Elbows		W111LR 45° L/R Elbows		W120 Tee		W160 Cap	
		C-E	Weight	C-E	Weight	C-E	Weight	E-E	Weight
in	in	in	Lbs	in	Lbs	in	Lbs	in	Lbs
mm	mm	mm	Kgs	mm	Kgs	mm	Kgs	mm	Kgs
10	10.750	15.000	78.0	6.25	39.0	—	—	—	—
250	273.0	381.0	35.4	158.8	17.7	—	—	—	—
12	12.750	18.000	114.6	7.50	57.3	—	—	—	—
300	323.9	457.2	52.0	190.5	26.0	—	—	—	—
14	14.000	21.00	149.4	8.75	74.8	11.00	110.2	6.50	35.0
350	355.6	533.4	67.9	222.3	34.0	279.4	50.0	165.0	15.9
16	16.000	24.00	195.8	10.00	98.1	12.00	145.4	7.00	44.0
400	406.4	609.6	89.0	254.0	44.6	304.8	66.1	178.0	20.0
18	18.000	27.00	248.6	11.25	124.3	13.50	169.8	8.00	56.1
450	457.2	685.8	113.0	285.5	56.5	342.9	77.0	203.0	25.5
20	20.000	30.00	308.0	12.50	154.0	15.00	209.4	9.00	70.0
500	508.0	762.0	140.0	317.5	70.0	381.0	95.0	229.0	31.8
22	22.000	33.00	371.8	13.50	187.0	16.50	277.2	10.00	85.4
550	558.8	838.2	169.0	342.9	85.0	419.1	126.0	254.0	38.8
24	24.000	36.00	444.4	15.00	222.2	17.00	267.9	10.50	99.2
600	609.6	914.4	202.0	381.0	101.0	431.8	121.5	267.0	45.1

* 22" availability upon request

Wrought Grooved Fittings

Model

W121 Reducing Tee

Material: ASTM A234 Gr. WPB, standard weight (0.375" or 9.5 mm), or carbon steel of

the same or equivalent grade.

C-E & C-B dimensions conform to ANSI B16.9

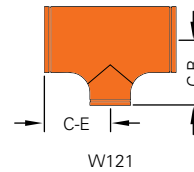

Nominal Size	Pipe O.D.	W121 Reducing Tee		Weight	Nominal Size	Pipe O.D.	W121 Reducing Tee		Weight
		C - E	C - B				C - E	C - B	
in	in	in	in	Lbs	in	in	in	in	Lbs
mm	mm	mm	mm	Kgs	mm	mm	mm	mm	Kgs
14 x 6	14.000 x 6.625	11.0	9.37	99.0	20 x 6	20.000 x 6.625	15.0	12.36	196.9
350 x 150	355.6 x 168.3	279.0	238.0	45.0	500 x 150	508.0 x 168.3	381.0	314.0	89.5
14 x 8	14.000 x 8.625	11.0	9.76	101.0	20 x 8	20.000 x 8.625	15.0	12.76	198.0
350 x 200	355.6 x 219.1	279.0	248.0	46.0	500 x 200	508.0 x 219.1	381.0	324.0	90.0
14 x 10	14.000 x 10.750	11.0	10.12	104.0	20 x 10	18.000 x 10.750	15.0	13.11	200.0
350 x 250	355.6 x 273.0	279.0	257.0	47.0	500 x 250	508.0 x 273.0	381.0	333.0	90.9
14 x 12	14.000 x 12.750	11.0	10.63	106.0	20 x 12	20.000 x 12.750	15.0	13.62	202.4
350 x 300	355.6 x 323.9	279.0	270.0	48.0	500 x 300	508.0 x 323.9	381.0	346.0	92.0
16 x 6	16.000 x 6.625	12.0	10.40	125.8	20 x 14	20.000 x 14.000	15.0	14.02	204.4
400 x 150	406.4 x 168.3	305.0	264.0	57.2	500 x 350	508.0 x 355.6	381.0	356.0	92.9
16 x 8	16.000 x 8.625	12.0	10.75	127.2	20 x 16	20.000 x 16.000	15.0	14.02	204.6
400 x 200	406.4 x 219.1	305.0	273.0	57.8	500 x 400	508.0 x 406.4	381.0	356.0	93.6
16 x 10	16.000 x 10.750	12.0	11.14	129.6	20 x 18	20.000 x 18.000	15.0	14.50	207.9
400 x 250	406.4 x 273.0	305.0	283.0	58.9	500 x 450	508.0 x 457.2	381.0	368.0	94.5
16 x 12	16.000 x 12.750	12.0	11.61	132.2	24 x 6	20.000 x 6.625	17.0	14.38	268.4
400 x 300	406.4 x 323.9	305.0	295.0	60.1	600 x 150	609.6 x 168.3	432.0	365.0	122.0
16 x 14	16.000 x 14.000	12.0	12.00	134.4	24 x 8	20.000 x 8.625	17.0	14.76	270.6
400 x 350	406.4 x 355.6	305.0	305.0	61.1	600 x 200	609.6 x 219.1	432.0	375.0	123.0
18 x 6	18.000 x 6.625	13.5	11.38	159.7	24 x 10	24.000 x 10.750	17.0	15.12	271.0
450 x 150	457.2 x 168.3	343.0	289.0	72.6	600 x 250	609.6 x 273.0	432.0	384.0	123.2
18 x 8	18.000 x 8.625	13.5	11.75	160.6	24 x 12	24.000 x 12.750	17.0	15.63	273.2
450 x 200	457.2 x 219.1	343.0	298.0	73.0	600 x 300	609.6 x 323.9	432.0	397.0	124.2
18 x 10	18.000 x 10.750	13.5	12.13	162.8	24 x 14	24.000 x 14.000	17.0	16.00	275.0
450 x 250	457.2 x 273.0	343.0	308.0	74.0	600 x 350	609.6 x 355.6	432.0	406.0	125.0
18 x 12	18.000 x 12.750	13.5	12.64	165.2	24 x 16	24.000 x 16.000	17.0	16.00	275.0
450 x 300	457.2 x 323.9	343.0	321.0	75.1	600 x 400	609.6 x 406.4	432.0	406.0	125.0
18 x 14	18.000 x 14.000	13.5	13.00	167.2	24 x 18	24.000 x 18.000	17.0	16.50	279.6
450 x 350	457.2 x 355.6	343.0	330.0	76.0	600 x 450	609.6 x 457.2	432.0	419.0	127.1
18 x 16	18.000 x 16.000	13.5	13.00	167.9	24 x 20	24.000 x 20.000	17.0	17.00	281.6
450 x 400	457.2 x 406.4	343.0	330.0	76.3	600 x 500	609.6 x 508.0	432.0	432.0	128.0

Wrought Grooved Fittings

Model

W150 Wrought Concentric Reducer W151 Wrought Eccentric Reducer

Material: ASTM A234 Gr. WPB, standard weight (0.375" or 9.5 mm), or segmentally welded carbon steel of the same or equivalent grade E-E dimensions conform to ANSI B16.9.

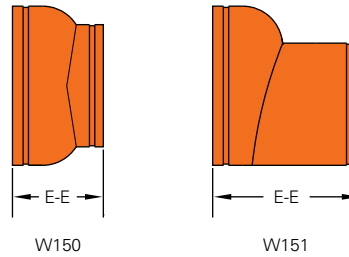

Nominal Pipe Size	Pipe O.D.	W150 Concentric Reducer		W151 Eccentric Reducer	
		E-E	Weight	E-E	Weight
in	in	in	Lbs	in	Lbs
mm	mm	mm	Kgs	mm	Kgs
14 x 6	14.000 x 6.625	13.00	67.76	13.00	67.76
350 x 150	355.6 x 168.3	330.0	30.8	330.0	30.8
14 x 8	14.000 x 8.625	13.00	69.96	13.00	69.96
350 x 200	355.6 x 219.1	330.0	31.8	330.0	31.8
14 x 10	14.000 x 10.750	13.00	71.94	13.00	71.94
350 x 250	355.6 x 273.0	330.0	32.7	330.0	32.7
14 x 12	14.000 x 12.750	13.00	73.92	13.00	73.92
350 x 300	355.6 x 323.9	330.0	33.6	330.0	33.6
16 x 8	16.000 x 8.625	14.00	87.78	14.00	87.78
400 x 200	406.4 x 219.1	356.0	39.9	356.0	39.9
16 x 10	16.000 x 10.750	14.00	90.86	14.00	90.86
400 x 250	406.4 x 273.0	356.0	41.3	356.0	41.3
16 x 12	16.000 x 12.750	14.00	92.84	14.00	92.84
400 x 300	406.4 x 323.9	356.0	42.2	356.0	42.2
16 x 14	16.000 x 14.000	14.00	94.82	14.00	94.82
400 x 350	406.4 x 355.6	356.0	43.1	356.0	43.1
18 x 10	18.000 x 10.750	15.00	111.76	15.00	111.76
450 x 250	457.2 x 273.0	381.0	50.8	381.0	50.8
18 x 12	18.000 x 12.750	15.00	114.84	15.00	114.84
450 x 300	457.2 x 323.9	381.0	52.2	381.0	52.2
18 x 14	18.000 x 14.000	15.00	117.70	15.00	117.70
450 x 350	457.2 x 355.6	381.0	53.5	381.0	53.5
18 x 16	18.000 x 16.000	15.00	120.78	15.00	120.78
450 x 400	457.2 x 406.4	381.0	54.9	381.0	54.9
20 x 12	20.000 x 12.750	20.00	159.72	20.00	159.72
500 x 300	508.0 x 323.9	508.0	72.6	508.0	72.6
20 x 14	20.000 x 14.000	20.00	163.68	20.00	163.68
500 x 350	508.0 x 355.6	508.0	74.4	508.0	74.4
20 x 16	20.000 x 16.000	20.00	167.64	20.00	167.64
500 x 400	508.0 x 406.4	508.0	76.2	508.0	76.2
20 x 18	20.000 x 18.000	20.00	171.60	20.00	171.6
500 x 450	508.0 x 457.2	508.0	78.0	508.0	78.0
24 x 16	24.000 x 16.000	20.00	197.56	20.00	197.56
600 x 400	609.6 x 406.4	508.0	89.8	508.0	89.8
24 x 18	24.000 x 18.000	20.00	199.54	20.00	199.54
600 x 450	609.6 x 457.2	508.0	90.7	508.0	90.7
24 x 20	24.000 x 20.000	20.00	203.50	20.00	203.50
600 x 500	609.6 x 508.0	508.0	92.5	508.0	92.5

Wrought Grooved Fittings

Model

W135 Cross W137 True-Y

Material: Fabricated with ASTM A234 Gr. WPB, standard weight (0.375" or 9.5 mm), or segmentally welded carbon steel of the same or equivalent grade.

C-LE and C-SE dimensions: manufacturer's standard.

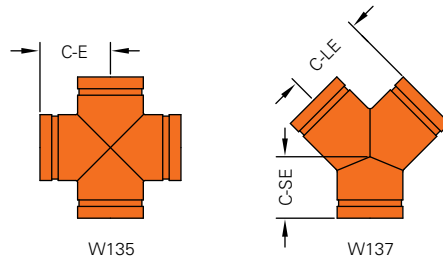

Nominal Size	Pipe O.D.	W135 Cross		W137 True Wye		
		C-E	Weight	C-LE	C-SE	Weight
in	in	in	Lbs	in	in	Lbs
mm	mm	mm	Kgs	mm	mm	Kgs
14	14.000	11.00	121.0	11.00	7.50	98.0
350	355.6	279	54.9	279	191	44.4
16	16.000	12.00	146.4	12.00	8.00	119.3
400	406.4	305	66.4	305	203	54.1
18	18.000	13.50	185.4	13.50	8.50	148.3
450	457.2	343	84.1	343	216	67.3
20	20.000	15.00	229.1	15.00	9.00	180.4
500	508.0	381	103.9	381	229	81.8
24	24.000	17.00	298.7	17.00	10.00	238.3
600	609.6	432	135.5	432	254	108.1

Wrought Long Radius Elbows (Bends)

1. Long radius 90° elbows 3D, 5D, and 6D in sizes up to and including 4" are provided with 4" (102 mm) long tangents, sizes 5" to 10" are provided with 1D long tangents and sizes 12" to 24" are provided with 12" (305 mm) long tangents.

2. End Preparation: Roll-grooved to AWWA C606-04 and or ISO/FDIS 6182-12. For dimensional tolerances of cast fittings, refer to ISO/FDIS 6182-12 Table 3.

- Plain-end, beveled end or cut-grooved ends are also available upon request.

3. Material: Standard wall steel pipe to

ASTM A53, Grade B. Other materials also available on request.

4. C to E tolerances: 2" through 6" $\pm \frac{1}{8}$ " (3.2 mm); 8" through 16" $\pm \frac{1}{4}$ " (6.4 mm); 18" through 24" $\pm \frac{3}{8}$ " (9.5 mm).

5. All weights are approximate, based on calculated weight of pipe.

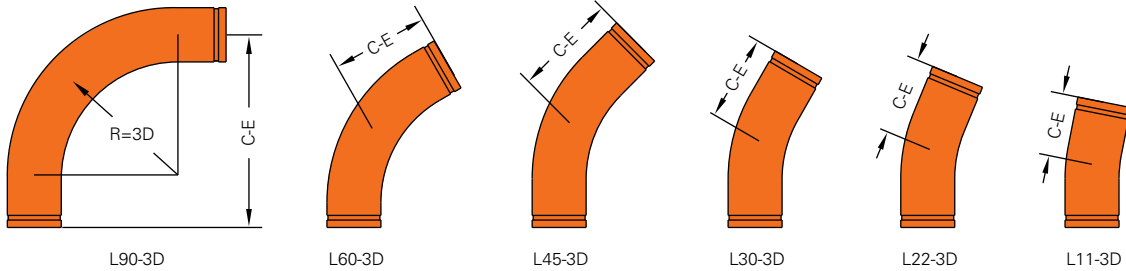

Wrought 3D Elbows

Model

L90-3D 90° **L60-3D 60°** **L45-3D 45°**
L30-3D 30° **L22-3D 22½°** **L11-3D 11¼°**



12" 3D 90° elbows ready for shipment

Nominal Size	Pipe O.D.	L90-3D 90° Elbow		L60-3D 60° Elbow		L45-3D 45° Elbow		L30-3D 30° Elbow		L22-3D 22½° Elbow		L11-3D 11¼° Elbow	
		C - E	Weight	C - E	Weight	C - E	Weight	C - E	Weight	C - E	Weight	C - E	Weight
in	in	in	Lbs	in	Lbs	in	Lbs	in	Lbs	in	Lbs	in	Lbs
mm	mm	mm	Kgs	mm	Kgs	mm	Kgs	mm	Kgs	mm	Kgs	mm	Kgs
2	2.375	10.0	5.5	7.50	4.3	6.50	3.7	5.75	3.4	5.25	3.2	4.50	2.8
50	60.3	254	2.5	191	2.0	165	1.7	146	1.5	133	1.5	114	1.3
2½	2.875	11.5	9.9	8.25	7.7	7.25	6.7	6.00	5.8	5.50	5.3	4.75	4.6
65	73.0	292	4.5	210	3.5	184	3.0	152	2.6	140	2.4	121	2.1
3	3.500	13.0	14.6	9.25	11.0	7.75	10.1	6.50	8.0	5.75	7.3	5.00	6.2
80	88.9	330	6.6	235	5.0	197	4.6	165	3.6	146	3.3	127	2.8
3½	4.000	14.5	18.6	10.00	14.4	8.50	12.0	6.75	10.2	6.00	9.2	5.00	7.6
90	101.6	368	8.4	254	6.5	216	5.6	171	4.6	152	4.2	127	3.4
4	4.500	16.0	22.4	11.00	18.5	9.00	14.7	7.25	12.8	6.50	11.4	5.25	9.3
100	114.3	406	10.2	279	8.4	229	7.0	184	5.8	165	5.2	133	4.2
5	5.563	20.0	40.5	13.75	31.3	11.25	26.9	9.00	21.8	8.00	19.4	6.50	15.8
125	141.3	508	18.4	349	14.2	286	12.2	229	9.9	203	8.8	165	7.2
6	6.625	24.0	60.7	16.50	48.8	13.50	39.7	10.75	33.9	9.50	30.1	7.75	24.6
150	168.3	610	27.5	419	22.1	343	18.0	273	15.4	241	13.7	197	11.2
8	8.625	32.0	132.3	22.00	97.9	18.00	86.0	14.50	68.0	12.75	60.5	10.50	49.3
200	219.1	813	60.0	559	44.4	457	39.0	368	30.8	324	27.4	267	22.4
10	10.750	40.0	211.6	27.25	173.4	22.50	136.7	18.00	120.5	16.00	107.2	13.00	87.3
250	273.0	1016	96.0	692	78.7	572	62.0	457	54.7	406	48.6	330	39.6
12	12.750	48.0	319.7	32.75	254.8	27.00	205.0	21.75	177.0	19.25	157.5	15.50	128.3
300	323.9	1219	145.0	832	115.6	686	93.0	552	80.3	489	71.4	394	58.2
14	14.000	54.0	390.2	38.25	327.3	31.50	227.3	25.25	227.3	22.50	202.3	18.25	164.8
350	355.6	1372	177.0	972	148.5	800	103.1	641	103.1	572	91.8	464	74.8
16	16.000	60.0	546.8	43.75	429.0	36.00	350.5	29.00	297.9	25.25	265.2	20.75	216.0
400	406.4	1524	248.0	1111	194.6	914	159.0	737	135.1	648	120.3	527	98
18	18.000	66.0	639.2	49.25	544.4	40.25	461.3	32.50	378.1	28.75	336.5	23.35	274.1
450	457.2	1676	290.6	1251	246.9	1029	209.2	826	171.5	730	152.6	593	124.3
20	20.000	72.0	778.6	54.75	673.5	45.00	568.8	36.00	467.8	32.00	416.3	26.00	339.2
500	508.0	1829	353.15	1391	305.5	1143	258.0	914	212.2	813	188.8	660	153.9
24	24.000	84.0	1442.5	65.50	1297.5	53.75	1099.6	43.25	903.5	38.25	804.5	31.00	655.1
600	609.6	2134	654.3	1664	588.5	1365	498.8	1099	409.8	972	364.9	787	297.2
28	28.000	95.0	1897.5	70.00	1714.5	62.00	1486.6	47.00	1150.7	45.00	1109.3	35.00	868.6
700	711.2	2413	860.7	1778	777.7	1575	674.3	1194	522.0	1143	503.2	889	394.0

* For 24" & 28": Made by XS (12.7 mm) carbon steel pipe to ASTM A53.

Wrought 5D Elbows

Model

L90-5D 90° L60-5D 60° L45-5D 45°
L30-5D 30° L22-5D 22½° L11-5D 11¼°

Nominal Size	Pipe O.D.	L90-5D 90° Elbow		L60-5D 60° Elbow		L45-5D 45° Elbow		L30-5D 30° Elbow		L22-5D 22½° Elbow		L11-5D 11¼° Elbow	
		C - E	Weight	C - E	Weight	C - E	Weight	C - E	Weight	C - E	Weight	C - E	Weight
in	in	in	Lbs	in	Lbs	in	Lbs	in	Lbs	in	Lbs	in	Lbs
mm	mm	mm	Kgs	mm	Kgs	mm	Kgs	mm	Kgs	mm	Kgs	mm	Kgs
2	2.375	14.00	7.2	9.75	5.6	8.25	4.8	6.75	4.0	6.00	3.6	5.00	3.0
50	60.3	356	3.3	248	2.5	210	2.2	171	1.8	152	1.6	127	1.4
2½	2.875	16.50	13.3	11.25	10.2	9.25	8.6	7.50	7.0	6.50	6.2	5.25	5.0
65	73.0	419	6.1	286	4.6	235	3.9	191	3.2	165	2.8	133	2.3
3	3.500	19.00	19.9	12.75	15.0	10.25	12.5	8.00	10.0	7.00	8.8	5.50	6.9
80	88.9	483	9.0	324	6.8	260	5.7	203	4.5	178	4.0	140	3.1
3½	4.000	21.50	26.9	12.25	20.0	11.25	16.5	8.75	13.0	7.50	11.3	5.75	8.7
90	101.6	546	12.2	311	9.1	286	7.5	222	5.9	191	5.1	146	3.9
4	4.500	24.00	35.4	15.50	26.0	12.50	21.3	9.50	16.6	8.00	14.3	6.00	10.7
100	114.3	610	16.1	394	11.8	318	9.7	241	7.5	203	6.5	152	4.9
5	5.563	30.00	59.9	19.50	44.1	15.50	36.1	11.75	28.1	10.00	24.1	7.50	18.2
125	141.3	762	27.2	495	20.0	394	16.4	298	12.7	254	10.9	191	8.3
6	6.625	36.00	93.3	23.25	68.6	18.50	56.2	14.00	43.8	12.00	37.6	9.00	28.3
150	168.3	914	42.4	591	31.1	470	25.5	356	19.9	305	17.1	229	12.8
8	8.625	48.00	187.4	31.00	137.7	24.50	112.8	18.75	87.9	16.00	75.4	12.00	56.8
200	219.1	1219	85.2	787	62.5	622	51.2	476	39.9	406	34.2	305	25.8
10	10.750	60.00	332.0	39.00	244.1	30.75	199.9	23.50	155.8	20.00	133.7	15.00	100.6
250	273.1	1524	150.9	991	110.7	781	90.7	597	70.7	508	60.6	381	45.6
12	12.750	72.00	488.0	46.75	358.6	37.00	293.7	28.00	228.9	24.00	196.4	18.00	147.8
300	323.9	1829	221.8	1187	162.7	940	133.2	711	103.8	610	89.1	457	67.0
14	14.000	82.00	608.5	54.50	460.7	43.00	377.3	32.75	294.0	28.00	252.3	21.00	189.8
350	355.6	2083	276.6	1384	209	1092	171.1	832	133.4	711	114.4	533	86.1
16	16.000	92.00	779.7	62.25	603.8	49.25	494.5	37.50	385.3	32.00	330.7	24.00	248.8
400	406.4	2337	354.4	1581	273.9	1251	224.3	953	174.8	813	150	610	112.9
18	18.000	102.00	971.4	70.00	766.2	55.25	627.6	42.25	489.0	36.00	419.7	27.00	315.7
450	457.2	2591	441.5	1778	347.5	1403	284.7	1073	221.8	914	190.4	686	143.2
20	20.000	112.00	1184.9	77.75	947.9	61.50	776.4	46.75	605.0	40.00	519.2	30.00	390.6
500	508.0	2845	538.6	1975	430.0	1562	352.2	1187	274.4	1016	235.5	762	177.2
24	24.000	132.00	1674.9	93.25	1369.3	73.75	1121.6	56.25	873.9	48.00	750.1	35.75	564.3
600	609.6	3353	761.3	2369	621.1	1873	508.7	1429	396.4	1219	340.2	908	256.0

Wrought 6D Elbows

Model

L90-6D 90° L60-6D 60° L45-6D 45°
L30-6D 30° L22-6D 22½° L11-6D 11¼°

Nominal Size	Pipe O.D.	L90-6D 90° Elbow		L60-6D 60° Elbow		L45-6D 45° Elbow		L30-6D 30° Elbow		L22-6D 22½° Elbow		L11-6D 11¼° Elbow	
		C - E	Weight	C - E	Weight	C - E	Weight	C - E	Weight	C - E	Weight	C - E	Weight
in	in	in	Lbs	in	Lbs	in	Lbs	in	Lbs	in	Lbs	in	Lbs
mm	mm	mm	Kgs	mm	Kgs	mm	Kgs	mm	Kgs	mm	Kgs	mm	Kgs
2	2.375	16.00	8.2	11.00	6.3	9.00	5.3	7.25	4.3	6.50	3.9	5.25	3.2
50	60.3	406	3.7	279	2.9	229	2.4	184	2.0	165	1.8	133	1.5
2½	2.875	19.00	15.2	12.75	11.4	10.25	9.5	8.00	7.7	7.00	6.7	5.50	5.3
65	73.0	483	6.9	324	5.2	260	4.3	203	3.5	178	3.0	140	2.4
3	3.500	22.00	22.9	14.50	17.0	11.50	14	8.75	11.0	7.50	9.5	5.75	7.3
80	88.9	559	10.4	368	7.7	292	6.4	222	5.0	191	4.3	146	3.3
3½	4.000	25.00	31.1	16.25	22.8	12.75	18.6	9.75	14.4	8.25	12.3	6.00	9.2
90	101.6	635	14.1	413	10.3	324	8.4	248	6.5	210	5.6	152	4.2
4	4.500	28.00	41.0	18.00	29.8	14.00	24.1	10.50	18.5	8.75	15.7	6.50	11.4
100	114.3	711	18.6	457	13.5	356	10.9	267	8.4	222	7.1	165	5.2
5	5.563	35.00	69.5	22.25	50.5	17.50	40.9	13.00	31.3	11.00	26.5	8.00	19.4
125	141.3	889	31.6	565	22.9	445	18.6	330	14.2	279	12.0	203	8.8
6	6.625	42.00	108.2	26.75	78.6	21.00	63.7	15.75	48.8	13.25	41.3	9.50	30.1
150	168.3	1067	49.2	679	35.7	533	28.9	400	22.1	337	18.7	241	13.7
8	8.625	56.00	217.2	35.75	157.7	28.00	127.8	21.00	97.9	17.50	82.9	12.75	60.5
200	219.1	1422	98.7	908	71.5	711	58.0	533	44.4	445	37.6	324	27.4
10	10.750	70.00	384.9	44.75	279.4	35.00	226.4	26.00	173.4	22.00	146.9	16.00	107.2
250	273.1	1778	174.9	1137	126.7	889	102.7	660	78.7	559	66.6	406	48.6
12	12.750	84.00	565.8	53.50	410.5	41.75	332.7	31.25	254.8	26.25	215.9	19.00	157.5
300	323.9	2134	257.2	1359	186.2	1060	150.9	794	115.6	667	97.9	483	71.4
14	14.000	96.00	708.4	62.50	527.3	48.75	427.3	36.50	327.3	30.75	277.3	22.25	202.3
350	355.6	2438	322.0	1588	239.2	1238	193.8	927	148.5	781	125.8	565	91.8
16	16.000	108.00	910.6	71.50	691.1	55.75	560.1	41.75	429.0	35.25	363.5	25.50	265.2
400	406.4	2743	413.9	1816	313.5	1416	254.1	1060	194.6	895	164.9	648	120.3
18	18.000	120.00	1137.4	80.50	877.1	62.75	710.7	47.00	544.4	39.50	461.3	28.75	336.5
450	457.2	3048	517.0	2045	397.8	1594	322.4	1194	246.9	1003	209.2	730	152.6
20	20.000	132.00	1390.4	89.25	1085.1	69.75	879.3	52.25	673.5	44.00	570.7	31.75	416.3
500	508.0	3353	632.0	2267	492.2	1772	398.8	1327	305.5	1118	258.9	806	188.8
24	24.000	156.00	1972.1	107.25	1567.5	83.75	1270.3	62.50	973.0	52.34	824.4	38.25	601.4
600	609.6	3962	896.4	2724	711	2127	576.2	1588	441.3	1329	373.9	972	272.8

Extra Heavy Cut Grooved Fittings "EP" (End Protection)

Model

10EP 90° EP Elbow 20EP EP Tee 11EP 45° EP Elbow 35EP EP Cross

Shurjoint offers a variety of fittings with extra heavy (Sch. 80) wall thickness and "EP" cut grooves available for use with XH-70EP couplings. These fittings must be used with

XH-70EP couplings in high pressure systems where the system pressure exceeds the published ratings for XH-1000 or Model 7707 couplings.

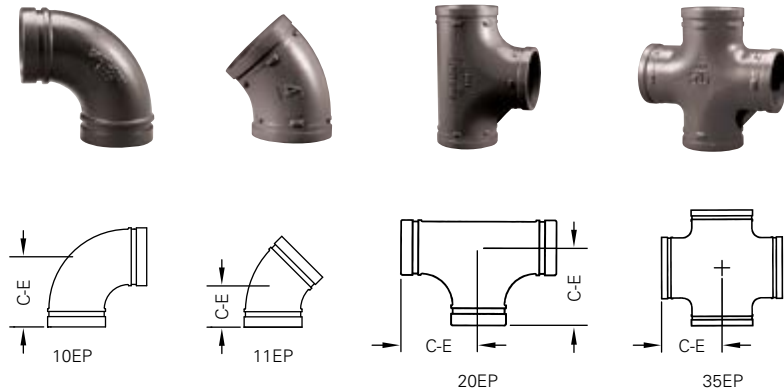

Nominal Size	Pipe O.D.	#10EP 90° Elbows		#11EP 45° Elbows		#20EP Tee		#35EP Cross	
		C - E	Weight	C - E	Weight	C - E	Weight	C - E	Weight
in	in	in	Lbs	in	Lbs	in	Lbs	in	Lbs
mm	mm	mm	Kgs	mm	Kgs	mm	Kgs	mm	Kgs
2	2.375	3.25	2.5	2.00	1.8	3.25	4.2	3.25*	3.9
50	60.3	83	1.1	51	0.8	83	1.9	83	1.8
2½	2.875	3.75	5.0	2.25*	2.9	3.75*	7.9	3.75*	6.6
65	73.0	95	2.3	57	1.3	95	3.6	95	3.0
3	3.500	4.25	6.0	2.50*	4.3	4.25*	16.0	4.25*	14.2
80	88.9	108	2.7	64	1.9	108	7.3	108	6.4
4	4.500	5.00	10.3	3.00*	8.5	5.00*	23.5	5.00*	15.8
100	114.3	127	4.7	76	3.9	127	10.7	127	7.2
6	6.625	6.50	27.2	3.50*	16.5	6.50*	27.0	6.50*	46.0
150	168.3	165	12.3	89	7.5	165	12.2	165	20.9

For "EP" cut-grooves, see page 30.

*Non-standard/stock items may require longer lead time.

Model

22EP Header Tee

The Shurjoint Model 22EP Header Tees are specifically designed for use in oilfield production headers where the top (test) line is 2" (50 mm) and the bottom production line is 3" (80 mm) or 4" (100 mm).

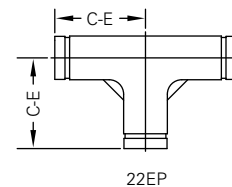

Fitting Size Mated C to E		#22EP Header Tee	
Nominal Size	Pipe O.D.	C - E	Weight
in	in	in	Lbs
mm	mm	mm	Kgs
2 to 3	2.375	4.25	3.4
50 to 80	60.3	108	1.5
2 to 4	2.875	5.00	4.1
50 to 100	73.0	127	1.9

Section 3

Stainless Steel Series

Shurjoint Stainless Steel Piping Series	84
Grooved Mechanical Couplings	
SS-5 Rigid Coupling	85
SS-7 Rigid Coupling	86
SS-7X Rigid Coupling.....	87
SS-8 Flexible Coupling.....	88
SS-8X Heavy Duty Flexible Coupling	89
SS-1200 High Pressure Flexible Coupling	90
SS-28 Hinged Lever Coupling.....	91
Cast Grooved Fittings	
SS-10 / SS-11 / SS-20 / SS-60 Elbows, Tee & Cap	92
SS-21 / SS-50 Reducing Tee & Concentric Reducer.....	93
SS-21F / SS-50F Reducing Tee & Concentric Reducer	94
Flange Adapters	
SS-41 / SS-80 Flange Adapters.....	95
Mechanical Tee, Y-Strainer & Valves	
SS-723 Mechanical Tee.....	96
SS-726 Y-Strainer	97
SJ-600L / SJ-600W Ball Valves.....	98
SJ-400 Butterfly Valves	99
SJ-630 Three Port Ball Valve	100
Pressure Performance Data	101

Stainless Steel Series

Shurjoint offers a full range of stainless steel grooved mechanical couplings in CF8 (304) and CF8M (316) for general service applications and in specialty alloys for applications including reverse osmosis and desalination systems. Grooved fittings are available in sizes from 1" (25 mm) to 24" (600 mm) produced in a combination of investment castings and wrought stainless.



Pressure ratings of stainless steel couplings

The design pressure rating of **Shurjoint** stainless steel grooved couplings follows Class 150 and is based on roll grooved Sch. 10S pipe. Pressure ratings will vary depending on the type of pipe used and grooves processed. See page 101 Performance Data Sheet for pressure ratings (CWP) when used with other pipe schedules and cut-grooved pipe.

Shurjoint ductile iron couplings can be used in conjunction with stainless steel pipe, depending on the application, as the flow media does not come in direct contact with coupling housings but rather only the gasket. See page 47 for performance data.

Stainless steel pipe in general is more difficult to groove than carbon steel pipe, as it is more difficult to achieve defined groove corners on stainless pipe. Grooves that are not defined and have too much of a radius could result in joint failure. Care must be taken to process grooves as defined as possible. For this reason, roll-groove machine manufacturers offer a variety of roll sets depending on the pipe material and wall thickness being grooved. Always select the correct roll set for the pipe being grooved.

Groove corners are not defined

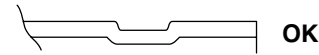
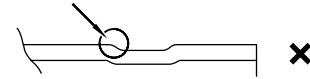

If the same roll-set that has been used for carbon steel pipe is used on stainless steel pipe, rust or scale may be transferred to the stainless steel pipe during processing of the groove. Thus we recommend the use of a separate roll set specifically for use with stainless steel pipe. Also use caution to keep roll grooved stainless steel pipe dry prior to installation.

Stainless Steel Casting Specifications

Grade (UNS)	Austenitic Stainless Steel			Duplex (Austenitic / Ferritic) Stainless Steel		
	CF8 J92600	CF8M J92900	CK3MCuN J93254	2A, CE8MN J93345	4A, CD3MN J92205	5A, CE3MN J93404
Composition, % (max, except where range is given)						
Carbon	0.08	0.08	0.025	0.08	0.03	0.03
Manganese	1.50	1.50	1.20	1.00	1.50	1.50
Silicon	2.00	1.50	1.00	1.50	1.00	1.00
Sulfur	0.040	0.040	0.010	0.040	0.020	0.040
Phosphorus	0.040	0.040	0.045	0.040	0.040	0.040
Chromium	18.0-21.0	18.0-21.0	19.5-20.5	22.5-25.5	21.0-23.5	24.0-26.0
Nickel	8.0-11.0	9.0-12.0	17.5-19.5	8.0-11.0	4.5-6.5	6.0-8.0
Molybdenum	0.50	2.0-3.0	6.0-7.0	3.0-4.5	2.5-3.5	4.0-5.0
Nitrogen			0.18-0.24	0.10-0.30	0.10-0.30	0.10-0.30
Copper			0.50-1.00		1.00	
Tensile Requirements, min.						
Tensile Strength, ksi (MPa)	70 (485)	70 (485)	80 (550)	95 (655)	90 (620)	100 (690)
Yield Strength, ksi (MPa)	30 (205)	30 (205)	38 (260)	65 (450)	60 (415)	75 (515)
Elongation, %	35	30	35	25	25	18
ASTM Standards	A351/ A743/A744	A351/A743/A744	A351/A743/A744	A890/A351	A890	A890
Wrought Equivalent Grade	304	316	254SMO*	45D*	2205	SAF 2507*

* 254SMO is a registered trademark of AvestaPolarit AB, 45D is a registered trademark of ESCO Corporation and SAF 2507 is a registered trademark of AB Sandvik Steel.

Model

SS-5 Stainless Steel Rigid Coupling

- Angle-Pad Design -

The Shurjoint Model SS-5 is an angle-pad design stainless steel coupling for use with Sch. 5S, Sch. 10S or Sch. 40S stainless steel pipe where a rigid connection is desired. The angle-pad design allows the coupling housings to slide along the bolt pads when tightened. The result is an offset clamping action which provides a rigid joint which resists so called 'snaking' of a long straight run. With the removal of only one

bolt you can make a fast and easy "swing-over" installation. The SS-5 couplings are comprised of two identical CF8 (304) or CF8M (316) housing segments, EPDM gaskets and stainless steel track bolts and heavy duty nuts.

The Shurjoint Model SS-5 is available with a standard "C" shaped or *GapSeal* gasket in a variety of grades to meet your specific service requirements.

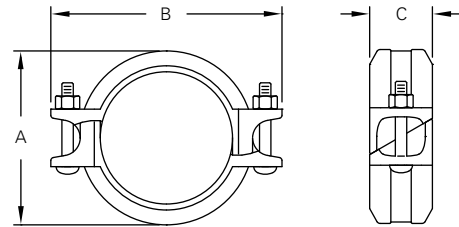

Nominal Size	Pipe O.D.	Max. Working Pressure (CWP)**	Max. End Load (CWP)	Axial Displacement †	Dimensions			Bolt		Weight
					A	B	C	No.	Size	
in	in	PSI	Lbs	in	in	in	in	No.	in	Lbs
mm	mm	Bar	kN	mm	mm	mm	mm			Kgs
1¼	1.660	600	1298	0 ~ 0.05	2.60	4.00	1.81	2	¾ x 2½	1.4
32	42.2	42	5.77	0 ~ 1.2	66	102	46	2	¾ x 2½	0.6
1½	1.900	600	1700	0 ~ 0.05	2.83	4.29	1.81	2	¾ x 2½	1.5
40	48.3	42	7.56	0 ~ 1.2	72	109	46	2	¾ x 2½	0.7
2	2.375	600	2657	0 ~ 0.07	3.35	4.61	1.85	2	¾ x 2¾	1.7
50	60.3	42	11.82	0 ~ 1.7	85	117	47	2	¾ x 2¾	0.8
2½	2.875	600	3893	0 ~ 0.07	3.86	5.20	1.85	2	¾ x 2¾	2.1
65	73.0	42	17.32	0 ~ 1.7	98	132	47	2	¾ x 2¾	0.9
3	3.500	600	5770	0 ~ 0.07	4.45	5.83	1.88	2	¾ x 2¾	2.6
80	88.9	42	25.67	0 ~ 1.7	113	148	48	2	¾ x 2¾	1.2
4	4.500	600	9538	0 ~ 0.16	5.75	7.17	2.09	2	¾ x 2¾	4.1
100	114.3	42	42.43	0 ~ 4.1	146	182	53	2	¾ x 2¾	1.9
5	5.563	600	14576	0 ~ 0.16	6.89	9.02	2.09	2	½ x 3	5.7
125	141.3	42	64.84	0 ~ 4.1	175	229	53	2	½ x 3	2.6
6	6.625	600	20672	0 ~ 0.16	8.00	9.80	2.13	2	½ x 3	6.8
150	168.3	42	91.96	0 ~ 4.1	203	249	54	2	½ x 3	3.1
8	8.625	600	35038	0 ~ 0.19	10.40	12.99	2.52	2	¾ x 4¾	13.4
200	219.1	42	155.86	0 ~ 4.8	264	330	64	2	¾ x 4¾	6.1

**The working pressure shown is based on roll-grooved Sch. 40S pipe. For other pipe schedules and cut-grooved pipe, see page 101.

† Allowable Axial Displacement and Angular Movement (deflection) figures are for roll grooved standard steel pipe. Values for cut grooved pipe will be double that of roll grooved. These values are maximums; for design and installation purposes these figures should be reduced by: 50% for ¾"/DN20 - 3½"/DN90; 25% for 4"/DN100 and larger to compensate for jobsite conditions.

Model SS-7 Stainless Steel Rigid Coupling

The Model SS-7 is a tongue and groove rigid coupling designed for a variety of moderate service pressure applications. The SS-7 is supplied standard in CF8 (304) and CF8M (316) with 304 and 316 bolts and nuts.

SS-7 couplings should always be installed so that the coupling bolt pads make metal to metal contact.

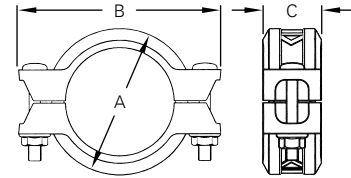

Nominal Size	Pipe O.D.	Max. Working Pressure (CWP)*	Max End Load (CWP)	Axial Displacement †	Dimensions			Bolt Size	Weight
					A	B	C		
in	in	PSI	Lbs	in	in	in	in	in	Lbs
mm	mm	Bar	kN	mm	mm	mm	mm		Kgs
1½	1.660	600	1298	0-0.06	2.68	4.13	1.75	¾ x 2½	1.5
32	42.2	42	5.77	0-1.6	68	105	45	¾ x 2½	0.7
1½	1.900	600	1700	0-0.06	2.91	4.25	1.81	¾ x 2½	1.8
40	48.3	42	7.56	0-1.6	74	108	46	¾ x 2½	0.8
2	2.375	600	2657	0-0.06	3.39	4.92	1.81	¾ x 2½	2.0
50	60.3	42	11.82	0-1.6	86	125	46	¾ x 2½	0.9
2½	2.875	600	3893	0-0.06	3.94	5.43	1.81	¾ x 2½	1.8
65	73.0	42	17.32	0-1.6	100	138	46	¾ x 2½	0.8
76.1 mm	3.000	600	4239	0-0.06	3.94	5.63	1.81	¾ x 2½	2.2
	76.1	42	18.86	0-1.6	100	143	46		1.0
3	3.500	600	5770	0-0.06	4.41	6.30	1.81	¾ x 2½	2.6
80	88.9	42	25.67	0-1.6	112	160	46	¾ x 2½	1.2
4	4.500	600	9538	0-0.13	5.63	8.15	2.00	½ x 3	4.6
100	114.3	42	42.43	0-3.2	143	207	51		2.1
139.7 mm	5.500	600	14248	0-0.13	6.77	9.09	2.00	½ x 3	6.2
	139.7	42	63.38	0-3.2	172	231	51		2.8
5	5.563	600	14576	0-0.13	6.73	9.29	2.00	½ x 3	5.9
125	141.3	42	64.84	0-3.2	171	236	51		2.7
165.1 mm	6.500	600	19900	0-0.13	7.68	10.04	2.09	½ x 3	6.8
	165.1	42	88.52	0-3.2	195	255	53		3.1
6	6.625	600	20672	0-0.13	7.91	10.08	2.00	½ x 3	6.8
150	168.3	42	91.96	0-3.2	201	256	51		3.1
8	8.625	600	35038	0-0.13	10.39	13.11	2.44	¾ x 3½	14.1
200	219.1	42	155.86	0-3.2	264	333	62		6.4
200 JIS	8.516	600	34158	0-0.13	10.12	13.62	2.44	¾ x 3½	13.2
	216.3	42	151.95	0-3.2	257	346	62		6.0

* The working pressure shown is based on roll-grooved Sch. 40S pipe. For other pipe schedules, see page 101.

† Allowable Axial Displacement and Angular Movement (deflection) figures are for roll grooved standard steel pipe. Values for cut grooved pipe will be double that of roll grooved. These values are maximums; for design and installation purposes these figures should be reduced by: 50% for ¾"/DN20 - 3½"/DN90; 25% for 4"/DN100 and larger to compensate for jobsite conditions.



The tongue and groove style rigid coupling may allow for rotation when installed on deeper than specified grooves.

Model

SS-7X Stainless Steel Rigid Coupling

The Model SS-7X is a tongue and groove rigid coupling designed to provide a rigid joint for stainless steel pipe in sizes 10" through 24". The SS-7X is supplied standard in CF8 (304) and CF8M (316) with 304 and 316 bolts and nuts. The bolts must be fastened to the required torque for proper installation.

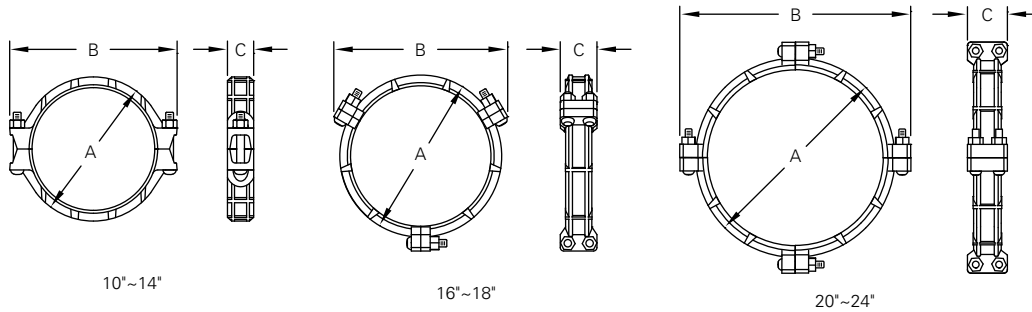

Nominal Size	Pipe O.D.	Max. Working Pressure (CWP)*	Max. End Load (CWP)	Axial Displacement †	Dimensions			Bolt		Bolt Torque	Weight
					A	B	C	No.	Size		
in	in	PSI	Lbs	in	in	in	in	No.	in	Lbs-Ft	Lbs
mm	mm	Bar	kN	mm	mm	mm	mm				
10	10.750	600	54430	0-0.13	12.52	15.98	2.56	2	7/8 x 6 1/2	105 - 175	23.1
250	273.0	42	239.87	0-3.2	318	406	65			145 - 235	10.5
12	12.750	600	76567	0-0.13	14.72	17.78	2.56	2	7/8 x 6 1/2	105 - 175	23.3
300	323.9	42	337.66	0-3.2	374	452	65			145 - 235	11.5
250 JIS	10.528	600	52205	0-0.13	12.44	16.73	2.52	2	7/8 x 6 1/2	105 - 175	18.7
	267.4	42	230.13	0-3.2	316	425	64			145 - 235	8.5
300 JIS	12.539	600	74054	0-0.13	14.57	18.31	2.52	2	7/8 x 6 1/2	105 - 175	21.6
	318.5	42	326.49	0-3.2	370	465	64			145 - 235	9.8
14	14.000	400	61544	0-0.13	15.63	19.69	2.95	2	7/8 x 6 1/2	105 - 175	33.0
350	355.6	28	277.94	0-3.2	397	500	75			145 - 235	15.0
16	16.000	400	80384	0-0.13	18.15	21.10	2.95	6	5/8 x 3 1/2	50 - 75	42.7
400	406.4	28	363.02	0-3.2	461	536	75			68 - 100	19.4
18	18.000	350	89019	0-0.13	20.24	23.11	2.95	6	5/8 x 3 1/2	50 - 75	55.0
450	457.2	24	393.82	0-3.2	514	587	75			68 - 100	25.0
20	20.000	350	109900	0-0.13	22.48	26.34	3.11	8	3/4 x 4 3/4	65 - 150	72.8
500	508.0	24	486.19	0-3.2	571	669	79			85 - 200	33.1
22	22.000	300	113982	0-0.13	24.49	28.35	3.11	8	3/4 x 4 3/4	65 - 150	72.6
550	558.8	20	490.24	0-3.2	622	720	79			85 - 200	33.0
24	24.000	300	135648	0-0.13	26.47	30.35	3.11	8	3/4 x 4 3/4	65 - 150	76.3
600	609.6	20	583.43	0-3.2	673	771	79			85 - 200	34.7

* The working pressure shown is based on roll-grooved Sch. 40S pipe. For other pipe schedules, see page 101.

† Allowable Axial Displacement and Angular Movement (deflection) figures are for roll grooved standard steel pipe. Values for cut grooved pipe will be double that of roll grooved. These values are maximums; for design and installation purposes these figures should be reduced by: 50% for 3/4"/DN20 - 3 1/2"/DN90; 25% for 4"/DN100 and larger to compensate for jobsite conditions.

Model

SS-8 Stainless Steel Flexible Coupling

The Model SS-8 is a flexible coupling designed for a variety of general service and specialty applications. The SS-8 is supplied standard in CF8 (304) and CF8M

(316) with 304 or 316 bolts and nuts. SS-8 couplings should always be installed so that the coupling bolt pads make metal to metal contact.

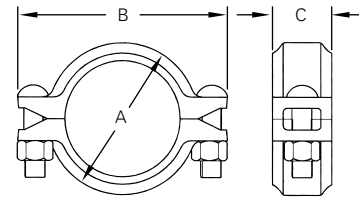

Nominal Size	Pipe O.D.	Max. Working Pressure (CWP)*	Max. End Load (CWP)	Axial Displacement †	Dimensions			Deflection Degree †	Bolt Size	Weight
					A	B	C			
in	in	PSI	Lbs	in	in	in	in	(°)	in	Lbs
mm	mm	Bar	kN	mm	mm	mm	mm			Kgs
1	1.315	500	679	0 - 0.06	2.19	3.45	1.73	2° - 45'	5/16 x 1 1/2	1.1
25	33.4	35	3.02	0 - 1.6	55.7	87.5	44.0			0.5
1 1/4	1.660	500	1082	0 - 0.06	2.54	3.85	1.73	2° - 10'	5/16 x 1 1/2	1.1
32	42.2	35	4.81	0 - 1.6	64.6	97.8	44.0			0.5
1 1/2	1.900	500	1417	0 - 0.06	2.79	4.14	1.73	1° - 54'	5/16 x 1 1/2	1.1
40	48.3	35	6.30	0 - 1.6	70.8	105.1	44.0			0.5
2	2.375	500	2214	0 - 0.06	3.28	4.88	1.73	1° - 31'	3/8 x 2 1/8	1.5
50	60.3	35	9.85	0 - 1.6	83.0	124.0	44.0			0.7
2 1/2	2.875	500	3244	0 - 0.06	3.79	5.51	1.73	1° - 15'	3/8 x 2 1/8	1.8
65	73.0	35	14.43	0 - 1.6	96.2	139.9	44.0			0.8
76.1 mm	3.000	500	3533	0 - 0.06	3.91	5.71	1.73	1° - 12'	3/8 x 2 1/8	1.8
	76.1	35	15.71	0 - 1.6	99.0	145.0	44.0			0.8
3	3.500	500	4808	0 - 0.06	4.39	6.18	1.73	1° - 02'	3/8 x 2 1/8	2.2
80	88.9	35	21.39	0 - 1.6	111.0	157.0	44.0			1.0
4	4.500	425	5166	0 - 0.13	5.62	7.87	1.97	1° - 36'	1/2 x 3	3.7
100	114.3	29	22.98	0 - 3.2	143.0	200.0	50.0			1.7
139.7 mm	5.500	425	4749	0 - 0.13	6.73	9.09	1.97	1° - 18'	1/2 x 3	4.8
	139.7	29	21.13	0 - 3.2	171.0	231.0	50.0			2.2
5	5.563	425	4859	0 - 0.13	6.72	8.90	1.97	1° - 18'	1/2 x 3	4.8
125	141.3	29	21.61	0 - 3.2	170.8	226.1	50.0			2.2
165.1 mm	6.500	425	6633	0 - 0.13	7.67	9.96	2.09	1° - 07'	1/2 x 3	5.9
	165.1	29	29.51	0 - 3.2	194.0	253.0	53.0			2.7
6	6.625	425	6891	0 - 0.13	7.80	9.96	2.09	1° - 05'	1/2 x 3	6.4
150	168.3	29	30.65	0 - 3.2	198.0	253.1	53.0			2.9
8	8.625	300	11386	0 - 0.13	10.04	13.27	2.44	0° - 50'	5/8 x 3 1/2	14.1
200	219.1	20	50.65	0 - 3.2	255.0	337.0	62.0			6.4
200 JIS	8.516	300	11679	0 - 0.13	10.00	13.62	2.40	0° - 51'	5/8 x 3 1/2	11.3
	216.3	20	51.95	0 - 3.2	251.0	346.0	60.0			5.1

* The working pressure shown is based on roll-grooved Sch. 40S pipe. For other pipe schedules and cut-grooved pipe, see page 102.

† Allowable Axial Displacement and Angular Movement (deflection) figures are for roll grooved standard steel pipe. Values for roll grooved pipe will be double that of roll grooved. These values are maximums; for design and installation purposes these figures should be reduced by: 50% for 3/4"/DN20 - 3 1/2"/DN90; 25% for 4"/DN100 and larger to compensate for jobsite conditions.

Model
**SS-8X Stainless Steel
 Heavy Duty Flexible Coupling**

The Model SS-8X is designed for high pressure applications including reverse osmosis and desalination systems. The SS-8X is available in stainless steel 304, stainless steel 316, Duplex CD3MN (2205),

Super Duplex CE8MN, CE3MN (2507) and 6-Moly stainless steel CK3MCuN (254SMO*). The SS-8X features 316 bolts, washers and Silicon Bronze nuts to help prevent galling during repetitive use.

The SS-8X is also available in CF8M (316) with 316 bolts and nuts. Contact Shurjoint for details.

* 254SMO is a registered trademark of AvestaPolarit AB.

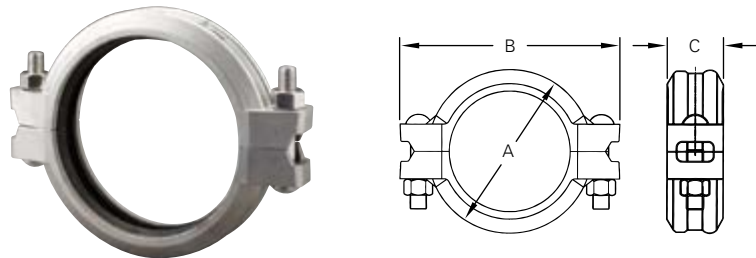

Nominal Size	Pipe O.D.	Max. Working Pressure (CWP)*	Max. End Load (CWP)	Axial Displacement †	Dimensions			Deflection Degree †	Bolt		Weight
					A	B	C		No	Size	
in	in	PSI	Lbs	in	in	in	in	(°)	No	in	Lbs
mm	mm	Bar	kN	mm	mm	mm	mm				Kgs
¾	1.050	750	1212	0 - 0.06	2.20	3.75	1.81	3° - 23'	2	¾ x 2½	1.5
20	26.7	52	5.39	0 - 1.6	56.0	95.0	46.0				0.7
1	1.315	750	1900	0 - 0.06	2.45	3.91	1.81	2° - 45'	2	¾ x 2½	1.8
25	33.4	52	8.45	0 - 1.6	63.0	99.0	46.0				0.8
1¼	1.660	750	3028	0 - 0.06	2.82	4.37	1.81	2° - 10'	2	¾ x 2½	2.0
32	42.2	52	13.47	0 - 1.6	72.0	111.0	46.0				0.9
1½	1.900	750	3967	0 - 0.06	3.06	4.82	1.81	1° - 54'	2	¾ x 2½	2.2
40	48.3	52	17.65	0 - 1.6	78.0	123.0	46.0				1.0
2	2.375	750	6199	0 - 0.06	3.46	5.28	1.85	1° - 31'	2	¾ x 2½	2.6
50	60.3	52	27.58	0 - 1.6	88.0	134.0	47.0				1.2
2½	2.875	750	9084	0 - 0.06	6.02	4.06	1.85	1° - 15'	2	¾ x 2½	2.9
65	73.0	52	40.41	0 - 1.6	153.0	103.0	47.0				1.3
3	3.500	750	13463	0 - 0.06	4.71	6.74	1.85	1° - 02'	2	½ x 3	4.0
80	88.9	52	59.89	0 - 1.6	120.0	171.0	47.0				1.8
4	4.500	750	22255	0 - 0.13	5.98	7.90	2.03	1° - 36'	2	½ x 3	5.3
100	114.3	52	99.00	0 - 3.2	152.0	201.0	52.0				2.4
5	5.563	750	24293	0 - 0.13	7.13	9.80	2.09	1° - 18'	2	¾ x 3½	7.7
125	141.3	52	108.07	0 - 3.2	181.0	249.0	53.0				3.5
6	6.625	300	34454	0 - 0.13	8.19	10.85	2.09	1° - 05'	2	¾ x 3½	8.8
150	168.3	20	153.27	0 - 3.2	208.0	276.0	53.0				4.0
8	8.625	300	58397	0 - 0.13	10.53	13.43	2.44	0° - 50'	2	¾ x 4¾	15.0
200	219.1	20	259.77	0 - 3.2	267.0	341.0	62.0				6.8
200 JIS	8.516	300	56930	0 - 0.13	10.39	13.31	2.44	0° - 51'	2	¾ x 4¾	14.3
	216.3	20	253.25	0 - 3.2	264.0	338.0	62.0				

Working pressure ratings are based upon generally accepted pressure piping design standards and testing in accordance with ASME Section VIII Division 1 pressure vessel test methods.

* The working pressure shown is based on cut-grooved Sch. 40S or 80S pipe. For other pipe schedules and roll-grooved pipe, see page 102.

† Axial Displacement and deflection figures are for roll grooved standard weight stainless steel pipe. Values for cut grooved pipe will be double that of roll grooved. These values are maximums; for design and installation purposes these figures should be reduced by: 50% for ¾"/DN20 - 3½"/DN90; 25% for 4"/DN100 and larger to compensate for jobsite conditions.

Model

SS-1200 Stainless Steel High Pressure Flexible Coupling

The Model SS-1200 is designed for high pressure applications including reverse osmosis, desalination and other specialty systems. The SS-1200 is available in strong and anti-corrosive alloys of Duplex CD3MN (2205), Super Duplex CE8MN, CE3MN

(2507) and 6-Moly stainless steel CK3MCuN (254SMO*). The SS-1200 features 316 bolts, washers and Silicon Bronze nuts to help prevent galling during repetitive use.

* 254SMO is a registered trademark of AvestaPolarit AB.

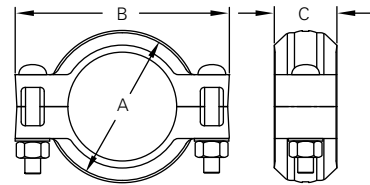

Nominal Size	Pipe O.D.	Max. Working Pressure (CWP)**	Max. End Load (CWP)	Axial Displacement †	Dimensions			Deflection Degree †	Bolt		Weight
					A	B	C		No	Size	
in	in	PSI	Lbs	in	in	in	in	(°)	No	in	Lbs
mm	mm	Bar	kN	mm	mm	mm	mm				Kgs
1	1.315	1200	1630	0 - 0.06	2.36	3.90	1.81	2° - 45'	2	3/8 x 2 1/2	1.21
25	33.4	83	7.25	0 - 1.6	60	99	46				0.55
1 1/4	1.660	1200	2595	0 - 0.06	2.76	4.17	1.81	2° - 10'	2	3/8 x 2 1/2	1.39
32	42.2	83	11.55	0 - 1.6	70	106	46				0.63
1 1/2	1.900	1200	3400	0 - 0.06	2.99	4.45	1.81	1° - 54'	2	3/8 x 2 1/2	1.54
40	48.3	83	15.13	0 - 1.6	76	113	46				0.70
2	2.375	1200	5315	0 - 0.06	3.50	5.31	1.85	1° - 31'	2	1/2 x 3	2.29
50	60.3	83	23.64	0 - 1.6	89	135	47				1.04
76.1 mm	3.000	1200	8470	0 - 0.06	4.01	6.04	1.91	1° - 15'	2	1/2 x 3	3.04
	76.1	83	38.19	0 - 1.6	102	153	49				1.38
3	3.500	1200	11540	0 - 0.06	4.69	6.61	1.85	1° - 02'	2	1/2 x 3	3.41
80	88.9	83	51.33	0 - 1.6	119	168	49				1.55
4	4.500	1200	19075	0 - 0.13	5.79	7.80	2.03	1° - 36'	2	5/8 x 3 1/2	4.69
100	114.3	83	84.86	0 - 3.2	147	198	52				2.13
6	6.625	1200	41346	0 - 0.13	7.95	10.71	2.05	1° - 05'	2	5/8 x 3 1/2	7.82
150	168.3	83	183.92	0 - 3.2	202	272	52				3.55
8	8.625	1200	68316	0 - 0.13	10.23	14.13	2.44	0° - 50'	2	7/8 x 5 1/2	15.55
200	219.1	83	30388	0 - 3.2	260	359	62				7.06

Working pressure ratings are based upon generally accepted pressure piping design standards and testing in accordance with ASME Section VIII Division 1 pressure vessel test methods.

** The working pressure shown is based on cut-grooved Sch. 40S or 80S pipe only. Burst test pressures are minimum 2 times the maximum working pressures.

† Allowable Axial Displacement and Angular Movement (deflection) figures are for roll grooved standard steel pipe. Values for cut grooved pipe will be double that of roll grooved. These values are maximums; for design and installation purposes these figures should be reduced by: 50% for 3/4"/DN20 - 3 1/2"/DN90; 25% for 4"/DN100 and larger to compensate for jobsite conditions.

The **Shurjoint Fast-fit™** gasket has been designed and engineered for easier and faster installations. The pipe-end friendly design eliminates struggling to stretch the gasket over the pipe ends and the Fast-fit™ gasket also features **Shurjoint's** Gap-Seal technology, which seals the gap between the pipe ends and eliminates stagnant water pockets within the gasket cavity. The Fast-fit™ gasket is UL classified in accordance with NSF/ANSI 61 and NSF/ANSI 372 for potable water (Cold Water +86°F / 30°C and Hot Water +180°F / +82°C).

Always use the factory supplied **Shurjoint Fast-fit™** gasket. Performance standards do not support the use of a standard gasket in the SS-1200 coupling.

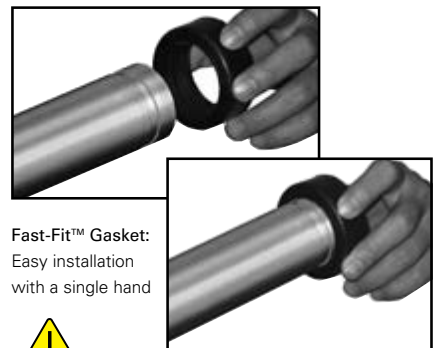

Fast-Fit™ Gasket:
Easy installation with a single hand



Always use the **Shurjoint Fast-fit™** gasket. Do not use a standard gasket with the SS-1200 coupling.

Model

SS-28 Stainless Steel Hinged Lever Coupling

The Model SS-28 Hinged Grooved Coupling is designed for quick connect and disconnect services. The housing segments are hinged with a lever handle for easy assembly. Use of the split pin can prevent the accidental opening of the coupling. The

Model SS-28 can be used in a wide variety of applications with standard roll- or cut-grooved pipe. Housings 1½" - 4" (40 mm - 100 mm) feature a smooth outer surface, housings 5" - 12" (125 mm - 300 mm) feature a cross-ribbed design for added

strength.

Standard gasket: Grade "E" EPDM or Grade "T" Nitrile.

Available standard in CF8 (304) or CF8M (316).

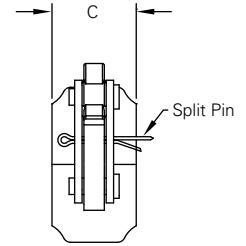
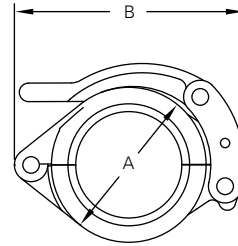

Nominal Size	Pipe O.D.	Max. Working Pressure (CWP)**	Max End Load (CWP)	Axial Displacement †	Dimensions			Deflection Degree †	Weight
					A	B	C		
in	in	PSI	Lbs	in	in	in	in	(°)	Lbs
mm	mm	Bar	kN	mm	mm	mm	mm		Kgs
1½*	1.900	300	1700	0 - 0.06	2.95	4.65	1.85	3° - 48'	2.2
40	48.3	20	7.56	0 - 1.6	75	118	47		1.0
2	2.375	300	2657	0 - 0.06	3.39	4.76	1.89	3° - 31'	2.4
50	60.3	20	11.82	0 - 1.6	86	121	48		1.1
3	3.500	300	5770	0 - 0.06	4.69	6.42	1.89	2° - 24'	4.0
80	88.9	20	25.67	0 - 1.6	119	163	48		1.8
4	4.500	300	9538	0 - 0.13	6.50	8.07	2.05	3° - 12'	5.9
100	114.3	20	42.43	0 - 3.2	165	205	52		2.7
5	5.563	200	9717	0 - 0.13	7.44	9.96	2.05	2° - 36'	10.8
125	141.3	14	43.23	0 - 3.2	189	253	52		4.9
6	6.625	200	13782	0 - 0.13	8.50	11.06	2.05	2° - 10'	12.8
150	168.3	14	61.31	0 - 3.2	216	281	52		5.8

** The working pressure shown is based on roll-grooved Sch. 40S pipe. For other pipe schedules and cut-grooved pipe, see page 102.

† Allowable Axial Displacement and Angular Movement (deflection) figures are for roll grooved standard steel pipe. Values for cut grooved pipe will be double that of roll grooved. These values are maximums; for design and installation purposes these figures should be reduced by: 50% for ¾"/DN20 - 3½"/DN90; 25% for 4"/DN100 and larger to compensate for jobsite conditions.

* Non-standard/stock items may require longer lead time.



Expansion Pipe

Lever handles are factory assembled tight for safety. The use of an expansion pipe will aid the easy opening and closing. Expansion pipes are available upon request.



Cast Grooved Fittings

Model

SS-10 90° Elbow
SS-11 45° Elbow

SS-20 Tee
SS-60 Cap

The Shurjoint Model SS-10, SS-11, SS-20 and SS-60 stainless steel grooved fittings are investment cast in sizes 1" - 12". These fittings are supplied in ASTM A351 or A743 austenitic grades CF8 (304) and CF8M (316). Materials are in compliance

with NSF/ANSI 372 for potable water service applications. In addition fittings are also available on request in CF3M (316L), 316Ti, 2205 Duplex, 2507 Super Duplex and ASTM CK-3MCuN (UNS J93245) the cast equivalent to 254SMO* to meet your

specific service requirements.

All cast fittings feature full flow characteristics and are designed to the same C - E dimensions of standard ductile iron grooved fittings.

* 254SMO is a registered trademark of AvestaPolarit AB.

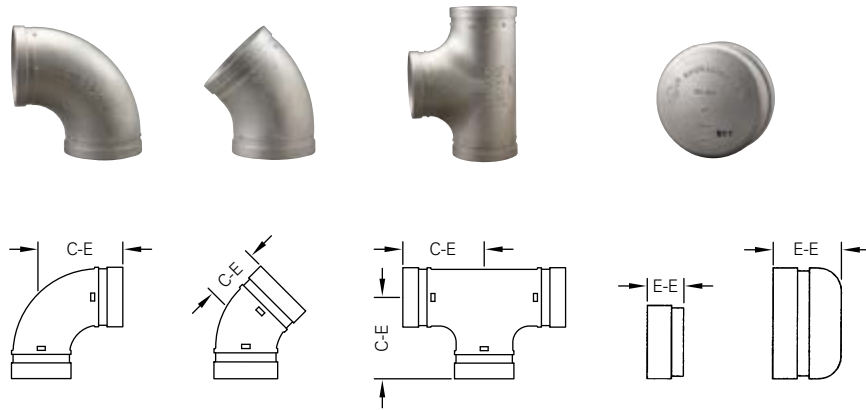

Nominal Size	Pipe O.D.	SS-10 90° Elbow		SS-11 45° Elbow		SS-20 Tee		SS-60 Cap	
		C - E	Weight	C - E	Weight	C - E	Weight	E - E	Weight
in	in	in	Lbs	in	Lbs	in	Lbs	in	Lbs
mm	mm	mm	Kgs	mm	Kgs	mm	Kgs	mm	Kgs
1	1.315	2.25	0.7	1.75	0.4	2.25	0.9	0.94	0.2
25	33.4	57	0.3	45	0.2	57	0.4	24	0.1
1¼	1.660	2.75	0.9	1.75	0.7	2.75	1.5	0.94	0.2
32	42.2	70	0.4	45	0.3	70	0.7	24	0.1
1½	1.900	2.75	0.9	1.75	0.9	2.75	1.8	0.94	0.4
40	48.3	70	0.4	45	0.4	70	0.8	24	0.2
2	2.375	3.25	1.3	2.00	1.1	3.25	2.4	0.94	0.4
50	60.3	83	0.6	51	0.5	83	1.1	24	0.2
2½	2.875	3.75	3.1	2.10	2.2	3.75	5.5	1.75	0.9
65	73.0	95	1.4	54	1.0	95	2.5	45	0.4
76.1 mm	3.000	3.75	3.5	2.25	2.2	3.75	5.5	1.75	0.9
	76.1	95	1.6	57	1.0	95	2.5	45	0.4
3	3.500	4.25	2.9	2.50	2.2	4.25	4.6	2.00	1.5
80	88.9	108	1.3	64	1.0	108	2.1	51	0.7
4	4.500	5.00	4.8	3.00	3.5	5.00	7.5	2.00	2.0
100	114.3	127	2.2	76	1.6	127	3.4	51	0.9
139.7 mm	5.500	5.50	8.6	3.25	6.2	5.50	12.3	2.38	3.5
	139.7	140	3.9	83	2.8	140	5.6	60	1.6
5	5.563	5.50	8.6	3.25	6.4	5.50	12.8	2.38	3.3
125	141.3	140	3.9	83	2.9	140	5.8	60	1.5
165.1 mm	6.500	6.50	13.6	3.50	9.0	6.50	19.8	3.00	5.7
	165.1	165	6.2	89	4.1	165	9.0	76	2.6
6	6.625	6.50	14.3	3.50	9.2	6.50	21.3	3.00	5.3
150	168.3	165	6.5	89	4.2	165	9.7	76	2.4
8	8.625	7.75	23.5	4.25	15.6	7.75	41.4	3.50	11.4
200	219.1	197	10.7	108	7.1	197	18.8	90	5.2
10	10.750	—	—	6.25	37.0	—	—	5.00	22.4
250	273.0	—	—	159	16.8	—	—	127	10.2
12	12.750	—	—	—	—	—	—	6.00	32.3
300	323.9	—	—	—	—	—	—	154	14.7
200 JIS	8.516	7.75	24.6	4.25	15.6	7.75	30.4	3.50	9.2
	216.3	197	11.2	108	7.1	197	13.8	90	4.2
250 JIS	10.528	—	—	6.25	37.0	—	—	5.00	19.6
	267.4	—	—	159	16.8	—	—	127	8.9
300 JIS	12.539	—	—	—	—	—	—	6.00	29.7
	318.5	—	—	—	—	—	—	154	13.5

Model

SS-21 Reducing Tee

SS-50 Concentric Reducer

The Shurjoint Model SS-21 and SS-50 stainless steel fittings are investment cast in sizes to 8" and sand cast or wrought in sizes 10" - 24".

Materials are in compliance with NSF/ANSI 372 for potable water service applications.

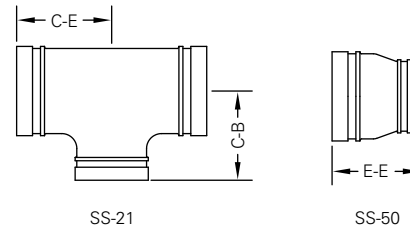

Nominal Size	Pipe O.D.	SS-21 Reducing Tee			SS-50 Concentric Reducer		Nominal Size	Pipe O.D.	SS-21 Reducing Tee			SS-50 Concentric Reducer	
		C-E	C-B	Weight	E - E	Weight			C-E	C-B	Weight	E - E	Weight
in	in	in	in	Lbs	in	Lbs	in	in	in	in	Kgs	in	Lbs
mm	mm	mm	mm	Kgs	mm	Kgs	mm	mm	mm	mm	Kgs	mm	Kgs
1 1/4 x 1	1.660 x 1.315	2.76	2.76	1.2	2.50	0.5	139.7 mm x 100	5.500 x 4.500	5.50	5.50	11.2	3.50	3.5
30 x 25	42.2 x 33.4	70	70	0.6	64	0.2	125 x 100	139.7 x 114.3	140	140	5.1	89	1.6
1 1/2 x 1	1.900 x 1.315	2.76	2.76	1.3	2.50	0.6	5 x 4	5.563 x 4.500	5.50	5.50	11.2	3.50	3.5
40 x 25	48.3 x 33.4	70	70	0.6	64	0.3	125 x 100	141.3 x 114.3	140	140	5.1	89	1.6
1 1/2 x 1 1/4	1.900 x 1.660	2.76	2.76	1.3	2.50	0.7	165.1 mm	6.500 x 3.500	5.91	5.91	15.6	4.00	5.1
40 x 32	48.3 x 42.2	70	70	0.6	64	0.3	x 80	165.1 x 88.9	150	150	7.1	102	2.3
2 x 1	2.375 x 1.315	2.76	2.76	1.5	2.50	0.8	165.1 mm	6.500 x 4.500	6.50	6.50	19.4	4.00	5.1
50 x 25	60.3 x 33.4	70	70	0.7	64	0.3	x 100	165.1 x 114.3	165	165	8.8	102	2.3
2 x 1 1/4	2.375 x 1.660	2.76	2.76	1.8	2.50	0.7	165.1 mm	6.500 x 5.500	6.50	6.50	19.4	4.00	5.7
50 x 32	60.3 x 42.2	70	70	0.8	64	0.7	x 139.7 mm	165.1 x 139.7	165	165	8.8	102	2.6
2 x 1 1/2	2.375 x 1.900	2.76	2.76	1.8	2.50	0.7	6 x 3	6.625 x 3.500	5.91	5.91	15.6	4.00	5.1
50 x 40	60.3 x 48.3	70	70	0.8	64	0.3	150 x 80	168.3 x 88.9	150	150	7.1	102	2.3
2 1/2 x 1	2.875 x 1.315	3.74	3.74	2.0	2.50	0.9	6 x 4	6.625 x 4.500	6.50	6.50	19.4	4.00	5.1
65 x 25	73.0 x 33.4	95	95	0.9	64	0.4	150 x 100	168.3 x 114.3	165	165	8.8	102	2.3
2 1/2 x 1 1/4	2.875 x 1.660	3.74	3.74	2.0	2.50	1.1	6 x 5	6.625 x 5.563	6.50	6.50	19.4	4.00	5.7
65 x 32	73.0 x 42.2	95	95	0.9	64	0.5	150 x 125	168.3 x 141.3	165	165	8.8	102	2.6
2 1/2 x 1 1/2	2.875 x 1.900	3.74	3.74	2.0	2.50	1.2	8 x 4	8.625 x 4.500	7.76	7.76	35.4	5.00	9.5
65 x 40	73.0 x 48.3	95	95	0.9	64	0.5	200 x 100	219.1 x 114.3	197	197	16.1	127	4.3
2 1/2 x 2	2.875 x 2.375	3.00	3.00	4.1	2.50	1.1	8 x 5	8.625 x 5.563	7.76	7.76	28.6	5.00	11.9
65 x 50	73.0 x 60.3	76	76	1.9	64	0.5	200 x 125	219.1 x 141.3	197	197	13.0	127	5.4
76.1 mm x 25	3.000 x 1.315	3.74	3.74	2.0	2.50	0.9	8 x 6	8.625 x 6.625	7.76	7.76	54.1	5.00	9.5
	76.1 x 33.4	95	95	0.9	64	0.4	200 x 150	219.1 x 168.3	197	197	24.6	127	4.3
76.1 mm x 32	3.000 x 1.660	3.74	3.74	2.0	2.50	1.1	10 x 6	10.750 x 6.625	9.02	9.02	59.2	6.00	18.3
	76.1 x 42.2	95	95	0.9	64	0.5	250 x 150	273.0 x 168.3	229	229	26.9	152	8.3
76.1 mm x 40	3.000 x 1.900	3.74	3.74	2.0	2.50	1.2	10 x 8	10.750 x 8.625	9.02	9.02	60.1	6.00	19.1
	76.1 x 48.3	95	95	0.9	64	0.5	250 x 200	273.0 x 219.1	229	229	27.3	152	8.7
76.1 mm x 50	3.000 x 2.375	3.00	3.00	3.3	2.50	1.1	12 x 8	12.750 x 8.625	10.00	10.00	56.1	7.00	49.5
	76.1 x 60.3	76	76	1.5	64	0.5	300 x 200	323.9 x 219.1	254	254	25.5	178	22.0
3 x 1 1/4	3.500 x 1.660	4.25	4.25	3.5	2.50	1.1	12 x 10	12.750 x 10.750	10.00	10.00	57.2	7.00	23.1
80 x 32	88.9 x 42.2	108	108	1.6	64	0.5	300 x 250	323.9 x 273.0	254	254	26.0	178	11.3
3 x 1 1/2	3.500 x 1.900	4.25	4.25	2.9	2.50	1.5	200 JIS x 100	8.516 x 4.500	7.76	7.76	35.4	5.00	9.5
80 x 40	88.9 x 48.3	108	108	1.3	64	0.6		216.3 x 114.3	197	197	16.1	127	4.3
3 x 2	3.500 x 2.375	4.25	4.25	4.6	2.50	1.3	200 JIS x 125	8.516 x 5.500	7.76	7.76	28.6	5.00	11.9
80 x 50	88.9 x 60.3	108	108	2.1	64	0.6		216.3 x 139.7	197	197	13.0	127	5.4
3 x 2 1/2	3.500 x 2.875	3.74	3.27	6.0	3.50	2.2	200 JIS x	8.516 x 6.500	7.76	7.76	54.1	5.00	9.5
80 x 65	88.9 x 73.0	95	83	2.7	89	1.0	165.1 mm	216.3 x 165.1	197	197	24.6	127	4.3
80 x 76.1 mm	3.500 x 3.000	3.74	3.27	4.6	3.50	2.2	250 JIS	10.528 x 6.500	9.02	9.02	59.2	6.00	18.3
	88.9 x 76.1	95	83	2.1	89	1.0	x 165.1 mm	273.0 x 165.1	229	229	26.9	152	8.3
4 x 2	4.500 x 2.375	5.00	5.00	7.3	3.00	2.2	250 JIS	10.528 x 8.516	9.02	9.02	60.1	6.00	19.1
100 x 50	114.3 x 60.3	127	127	3.3	76	1.0	x 200 JIS	267.4 x 216.3	229	229	27.3	152	8.7
4 x 2 1/2	4.500 x 2.875	4.49	3.86	8.8	4.00	3.1	300 JIS	12.539 x 8.516	10.00	10.00	56.1	7.00	49.5
100 x 65	114.3 x 73.0	114	98	4.0	102	1.4	x 200 JIS	318.5 x 216.3	254	254	25.5	178	22.0
100 x 76.1 mm	4.500 x 3.000	4.49	3.86	9.0	4.00	3.1	300 JIS	12.539 x 10.528	10.00	10.00	57.2	7.00	23.1
	114.3 x 76.1	114	98	4.1	102	1.4	x 250 JIS	318.5 x 267.4	254	254	26.0	178	11.3
4 x 3	4.500 x 3.500	4.49	3.86	7.0	3.00	2.0							
100 x 80	114.3 x 88.9	114	98	3.2	76	0.9							

Model

SS-21F Reducing Tee (GR X GR X FT) SS-50F Concentric Reducer (GR X FT)

The Shurjoint Model SS-21F and SS-50F stainless steel fittings are investment cast in sizes from 2½" to 4".

Materials are in compliance with NSF/ANSI 372 for potable water service applications.

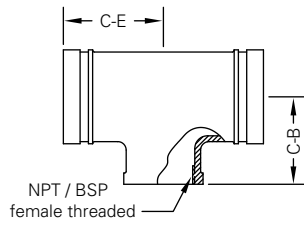

SS-21F

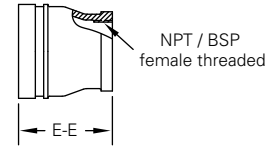

SS-50F

Nominal Size mm	Pipe O.D. mm	SS-21F Reducing Tee		Weight Kgs	SS-50F Concentric Reducer	
		C-E mm	C-B mm		E-E mm	Weight Kgs
65 x 40F	73.0/76.1 x 48.3	76	76	0.83	—	—
65 x 50F	73.0/76.1 x 60.3	—	—	—	89	0.95
80 x 50F	88.9 x 60.3	95	83	2.10	89	0.92
100 x 50F	114.3 x 60.3	114	98	3.20	102	1.76

* FT: NPT female threaded or BSP female threaded.

Model SS-41 Flange Adapter - ANSI 125/150

The Model SS-41 stainless steel flange adapter allows for a direct connection with ANSI Class 125/150 flanges. The SS-41 is investment cast in Gr. CF8 (304) or CF8M (316). Integral closure tabs located on the flange O.D. help facilitate alignment and assembly.

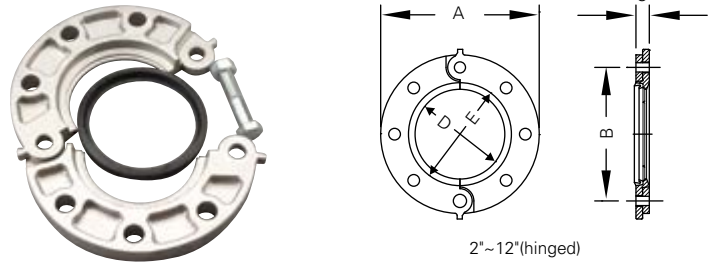

Nominal Size	Pipe O.D.	Max. Working Pressure (CWP)*	Max. End Load (CWP)	Dimensions			Sealing Surface		Bolt		Weight
				A	B	C	D	E	No.	Size	
in	in	PSI	Lbs	in	in	in	in	in			Lbs
mm	mm	Bar	kN	mm	mm	mm	mm	mm			Kgs
2	2.375	300	1330	6.00	4.75	0.75	2.28	3.07	4	5/8 x 3	4.6
50	60.3	20	5.71	152	121	19	58	78	4	5/8 x 3	2.1
2½	2.875	300	1950	7.00	5.50	0.87	2.72	3.54	4	5/8 x 3	6.0
65	73.0	20	8.37	178	140	22	69	90	4	5/8 x 3	2.7
3	3.500	300	2880	7.52	6.00	0.94	3.35	4.17	4	5/8 x 3	6.8
80	88.9	20	12.41	191	152	24	85	106	4	5/8 x 3	3.1
4	4.500	300	4770	9.00	7.50	0.94	4.33	5.20	8	5/8 x 3	9.9
100	114.3	20	20.51	229	191	24	110	132	8	5/8 x 3	4.5
6	6.625	300	10340	11.00	9.50	1.00	6.46	7.32	8	¾ x 3½	12.9
150	168.3	20	44.47	279	241	25	164	186	8	¾ x 3½	5.8
8	8.625	300	17520	13.50	11.75	1.14	8.46	9.29	8	¾ x 3½	20.2
200	219.1	20	75.37	343	298	29	215	236	8	¾ x 3½	9.2

* The working pressure shown is based on roll-grooved Sch. 40S pipe.

Model SS-80 Stainless Steel Universal Flange Adapter

The Model SS-80 Universal Flange Adapter provides for a rigid transition between a grooved piping system and a flanged piping system or component. The SS-80 can mate to ANSI 125/150, PN 10/16, BS-10E or JIS 10K, and is available standard in CF8 (304) or CF8M (316).

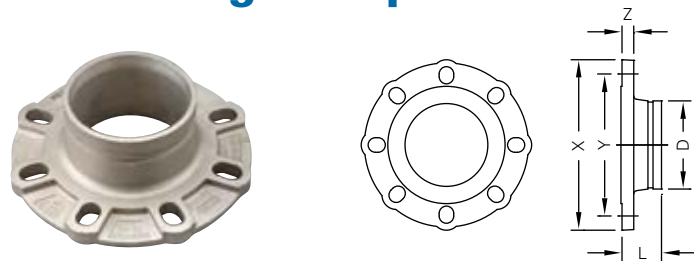

Nominal Size	Pipe O.D.	L	X	Y: Flange Drilling				Z	Bolt				Weight
				ANSI 125 / 150	PN 10	PN16	JIS 10K		ANSI 125 / 150	PN 10	PN16	JIS 10K	
in	in	in	in	in	in	in	in	in	Size	Size	Size	Size	Lbs
mm	mm	mm	mm	mm	mm	mm	mm	mm	No.	No.	No.	No.	Kgs
2	2.375	2.50	6.50	4.75	4.92	4.92	4.72	0.63	5/8	M16	M16	M16	4.4
50	60.3	64	165	121	125	125	120	16	4	4	4	4	2.0
2½*	2.875	3.00	7.28	5.50	5.70	5.70	5.50	0.63	5/8	---	---	---	6.4
65	73.0	76	185	140	145	145	140	16	4	---	---	---	2.9
76.1 mm	3.000	3.00	7.28	5.50	5.70	5.70	5.50	0.63	---	M16	M16	M16	6.6
	76.1	76	185	140	145	145	140	16	---	4	4	4	3.0
3	3.500	2.95	7.78	6.00	6.30	6.30	5.90	0.63	5/8	M16	M16	M16	7.5
80	88.9	75	200	152	160	160	150	16	8	8	8	8	3.4
4	4.500	2.95	8.86	7.50	7.09	7.09	6.89	0.63	5/8	M16	M16	M16	8.6
100	114.3	75	225	191	180	180	175	16	8	8	8	8	3.9
5	5.563	2.95	10.00	8.50	8.27	8.27	8.27	0.87	¾	---	---	---	14.7
125	141.3	75	254	216	210	210	210	22	8	---	---	---	6.7
6	6.625	2.95	10.71	9.50	9.45	9.45	9.45	0.63	¾	---	---	---	15.2
150	168.3	75	272	241	240	240	240	16	8	---	---	---	6.9
8	8.625	4.00	13.50	11.75	11.61	11.61	---	0.87	¾	M20	M20	---	31.9
200	219.1	102	343	298	295	295	---	22	8	8	12	---	14.5
	8.516	4.00	13.50	11.75	11.61	11.61	11.42	0.87	---	---	---	M20	30.8
200 JIS	216.3	102	343	298	295	295	290	22	---	---	---	12	14.0
	10	10.750	3.94	16.00	14.25	13.77	14.00	14.00	1.18	7/8	M20	M24	M22
250	273.0	100	406	362	350	355	355	30	12	12	12	12	22.5
12	12.750	4.45	19.00	17.00	15.75	16.14	---	1.26	7/8	M20	M24	---	65.9
300	323.9	113	483	432	400	410	---	32	12	12	12	---	29.9

Contact Shurjoint for other sizes.

Model

SS-723 Stainless Steel Mechanical Tee

The Shurjoint Model SS-723 stainless steel mechanical tee is the ideal fitting for branch or direct outlet connections to sprinkler heads, drop nipples and or gauges on stainless steel pipe. No need for welding,

simply cut or drill a hole at the desired location, position the housing so that the locating collar fits within the hole and secure with the bolts and nuts.

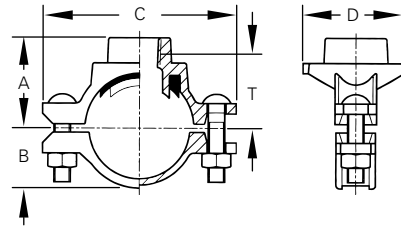

Nominal Size Run x Branch	Max. Working Pressure (CWP)*	Hole Dia. † +0.063, -0 / +1.6, -0	Dimensions					Bolt Size	Weight
			A	B	C	D	T±		
in	PSI	in	in	in	in	in	in	in	Lbs
mm	Bar	mm	mm	mm	mm	mm	mm	mm	Lbs
1 ¼ x ½	300	1.18	1.60	1.02	3.44	1.93	1.06	5/16 x 1 ½	0.7
32 x 15	20	30	41	26	87	49	27	5/16 x 1 ½	0.3
1 ¼ x ¾	300	1.18	1.70	1.02	3.44	1.93	1.14	5/16 x 1 ½	0.7
32 x 20	20	30	44	26	87	49	29	5/16 x 1 ½	0.3
1 ¼ x 1	300	1.18	2.00	1.02	3.44	1.93	1.34	5/16 x 1 ½	0.9
32 x 25	20	30	51	26	87	49	34	5/16 x 1 ½	0.4
1 ½ x ½	300	1.18	1.70	1.13	3.54	1.93	1.18	5/16 x 1 ½	0.7
40 x 15	20	30	44	29	90	49	30	5/16 x 1 ½	0.3
1 ½ x ¾	300	1.18	1.81	1.13	3.54	1.93	1.22	5/16 x 1 ½	0.7
40 x 20	20	30	46	29	90	49	31	5/16 x 1 ½	0.3
1 ½ x 1	300	1.18	2.09	1.13	3.54	1.93	1.42	5/16 x 1 ½	0.9
40 x 25	20	30	53	29	90	49	36	5/16 x 1 ½	0.4
2 x ½	300	1.18	2.00	1.42	4.28	2.00	1.46	5/16 x 1 ½	1.1
50 x 15	20	30	51	36	109	51	37	5/16 x 1 ½	0.5
2 x ¾	300	1.18	2.09	1.42	4.28	2.00	1.10	5/16 x 1 ½	1.1
50 x 20	20	30	53	36	109	51	28	5/16 x 1 ½	0.5
2 x 1	300	1.18	2.37	1.42	4.28	2.00	1.69	5/16 x 1 ½	1.4
50 x 25	20	30	60	36	109	51	43	5/16 x 1 ½	0.6

* Working pressure is based on standard wall stainless steel pipe.

† Hole diameters listed are suggested hole diameters.

± T: Take-out (Center of run to end of pipe to be engaged)

Model
SS-726 Stainless Steel Y-Strainer

The Model SS-726 Stainless Steel Grooved-end Y-Strainers are designed to strain debris and foreign matter from piping systems and thus provide inexpensive protection for costly pumps, meters and other

components. Cleaning and maintenance of the screen can be accomplished easily by removing the coupling. The Model SS-726 Stainless Steel Y-Strainer is suitable for vertical or horizontal installations.

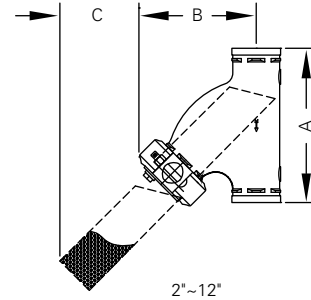

Nominal Size	Pipe O.D.	Max. Working Pressure (CWP)*	Dimensions			Drain Plug Size	Weight
			A	B	C		
in	in	PSI	in	in	in	in	Lbs
mm	mm	Bar	mm	mm	mm	mm	Kgs
2½	2.875	300	10.75	7.83	4.80	½	16.7
65	73.0	20	273	199	122	15	7.6
3	3.500	300	11.75	8.70	5.08	½	18.9
80	88.9	20	299	221	129	15	8.6
4	4.500	300	14.25	10.59	6.61	1	21.1
100	114.3	20	362	269	168	25	9.6
6	6.625	300	18.50	14.05	8.62	1	85.8
150	168.3	20	470	357	219	25	39.0

* Working pressure is based on connection with roll- or cut-grooved standard wall stainless steel pipe.

Model SJ-600L Ball Valve

The Model SJ-600L is a two-piece, full-port stainless steel ball valve rated at 600 psi (42 Bar) and is available in CF8M (316). The SJ-600L features a floating ball for lower torque and is supplied with a lever handle as well as ISO mounting holes to accommodate a full range of gear or power actuators.

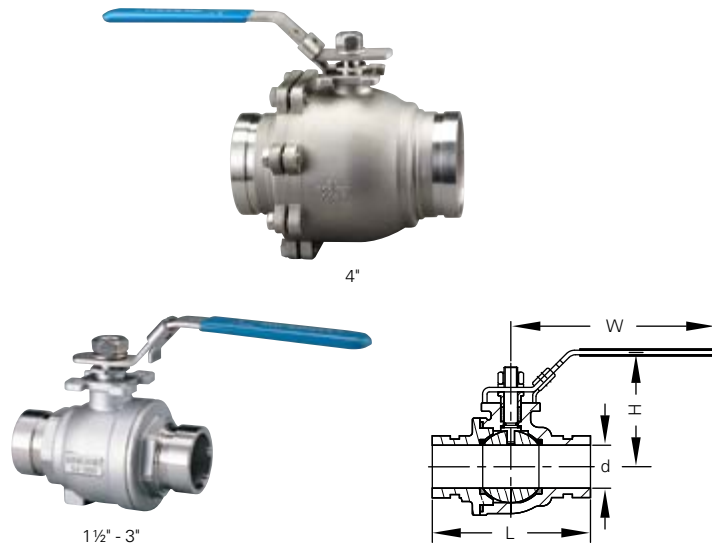

Nominal Size	Pipe O.D.	Max. Working Pressure (CWP)*	Operating Torque‡	Dimensions				Weight [^]
				L	H	W	d	
in	in	PSI	Lbs-in	in	in	in	in	Lbs
mm	mm	Bar	Nm	mm	mm	mm	mm	Kgs
1½	1.900	600	265	5.50	3.70	7.60	1.50	6.6
40	48.3	42	30	140	94	193	38	3.0
2	2.375	600	354	6.15	4.13	7.60	1.97	8.8
50	60.3	42	40	156	105	193	50	4.0
2½	2.875	600	442	7.09	4.33	9.84	2.56	15.4
65	73.0	42	50	180	110	250	65	7.0
76.1 mm	3.000	600	442	7.09	4.33	9.84	2.56	15.4
	76.1	42	50	180	110	250	65	7.0
3	3.500	600	619	8.42	6.00	9.84	3.07	20.7
80	88.9	42	70	214	152	250	78	9.4
4	4.500	600	973	9.45	6.57	11.42	3.94	55.0
100	114.3	42	110	240	167	290	100	25.0

* Working pressure is for connection with cut- or roll-grooved schedule Sch. 40S pipe.

‡ For the first opening or closing of the valve when the valve is not continuously operated, an additional torque of 2.0 – 2.5 times the listed operating torque is normally required.

[^] The weight includes the lever handle.

Model SJ-600W Ball Valve

The Model SJ-600W is supplied with a worm gear operator. The standard gear operator is supplied with a bracket and extension sleeve. Sizes available are 2" (50 mm) through 4" (100 mm).

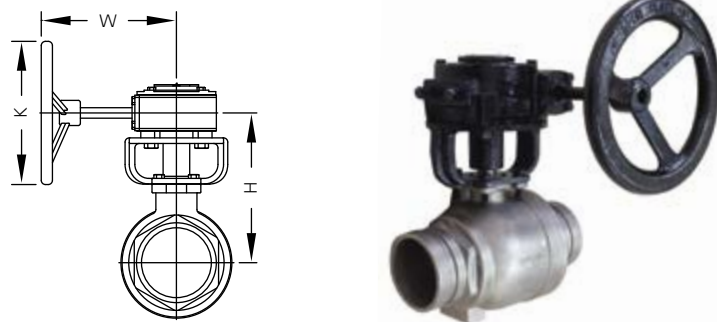

Nominal Size	Pipe O.D.	Dimensions			Weight
		K	H	W	
in	in	in	in	in	Lbs
mm	mm	mm	mm	mm	Kgs
2	2.375	5.98	5.38	8.00	17.82
50	60.3	152	137	203	8.10
2½	2.875	5.98	5.68	8.00	24.42
65	73.0	152	145	203	11.10
76.1 mm	3.000	5.98	5.68	8.00	24.42
	76.1	152	145	203	11.10
3	3.500	5.98	7.16	8.00	29.70
80	88.9	152	182	203	13.50
4	4.500	5.98	8.00	8.00	63.80
100	114.3	152	203	203	29.0

* The weight includes the worm gear operator.

Model SJ-400 Butterfly Valve

The Shurjoint Model SJ-400 Butterfly Valve is a grooved end stainless steel butterfly valve, supplied with a 10 position lever handle (SJ-400L) or worm gear operator (SJ-400W). The end-to-end dimensions conform to MSS SP-67. The body is available in CF8M (316) to

ASTM A743 with integral neck and ISO 5211 mounting pad. It features a dual seal disc encapsulated with Gr. E-pw EPDM for cold and hot water services. The end-to-end dimensions conform to MSS SP-67.



SJ-400-L
2" - 8"



SJ-400-W
2" - 8"

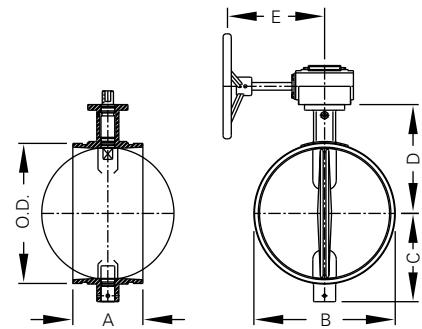
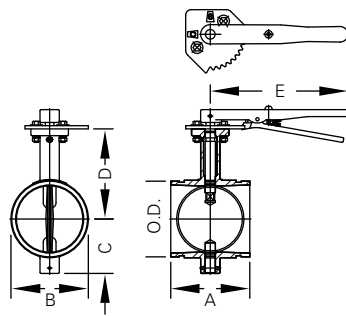

Nominal Size	Pipe O.D.	Max. Working Pressure (CWP)**	Dimensions					Operating Torque	Weight†
			A	B	C	D	E		
in	in	PSI	in	in	in	in	in	Lbs-in	Lbs
mm	mm	Bar	mm	mm	mm	mm	mm	Nm	Kgs
2	2.375	300	3.19	2.520	2.480	4.17	7.56	78	5.0
50	60.3	20	81	64	63	106	192	8.80	2.3
2½	2.875	300	3.81	3.150	2.677	4.28	7.56	84	7.0
65	73.0	20	97	80	68	111	192	9.50	3.2
76.1 mm*	3.000	300	3.81	3.150	2.677	4.28	7.56	84	7.0
	76.1	20	97	80	68	111	192	9.50	3.2
3	3.500	300	3.81	3.622	2.992	4.97	7.56	95	6.6
80	88.9	20	97	92	76	126	192	10.7	3.5
4	4.500	300	4.56	4.646	3.504	5.33	9.92	200	11.0
100	114.3	20	116	118	89	135	252	22.6	5.0
165.1 mm*	6.500	300	5.81	6.772	4.488	6.62	9.92	310	20.2
	165.1	20	148	172	114	168	252	34.9	9.2
6	6.625	300	5.81	6.772	4.488	7.25	13.46	310	20.2
150	168.3	20	148	172	114	184	342	34.9	9.2
200 JIS*	8.516	300	5.24	8.740	5.512	8.20	13.46	400	26.8
	216.3	20	133	222	140	208	342	45.1	12.2
8	8.625	300	5.24	8.740	5.512	8.20	13.46	400	26.8
200	219.1	20	133	222	140	208	342	45.1	12.2
10	10.75	150	6.3	11.181	7.32	9.25	14.02	1500	62.3
250	273	10	160	284	186	235	356	170	28.3
12	12.75	150	6.56	13.150	6.39	10.24	14.02	2000	88.1
300	323.9	10	166	334	213	260	356	226	40

† The weight includes the lever handle.

* Non-standard/stock items may require longer lead time.

** Working pressure is based on connection with roll- or cut-grooved standard wall stainless steel pipe.

Model
SJ-630 Three Port Ball Valve

The Shurjoint Model SJ-630 is a grooved-end three-port ball valve designed to divert media from bottom inlet to either of the two outlets ports. The valve port is a regular port size and the stem features a

blowout proof design to MSS SP-72 and API Standard 608. The valve body and trim materials are in compliance with NACE MR-01-75 requirements.

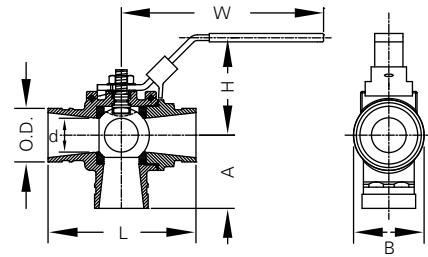

Nominal Size	Pipe O.D.	Max. Working Pressure (CWP)*	Dimensions						Weight
			L	H	W	d	A	B	
in	in	PSI	in	in	in	in	in	in	Lbs
mm	mm	Bar	mm	mm	mm	mm	mm	mm	Kgs
2	2.375	600	6.55	4.32	8.96	1.50	3.25	3.13	7.89
50	60.3	42	167	110	228	38	83	79	3.58

* Working pressure is based on connection with roll- or cut-grooved Sch. 40S stainless steel pipe.

Pressure Performance Data

Stainless Steel Couplings on Stainless Steel Pipe

The following tables show maximum cold working pressures (CWP) of Shurjoint stainless steel couplings used on stainless steel pipes.

In general it is more difficult to achieve defined groove corners on stainless steel pipe than on carbon steel pipe. Always select the correct roll set for the pipe being grooved and process grooves as defined as possible. Contact your roll-groove tool manufacturer for recommendations.

Model SS-7X Rigid Coupling

Nom. Size	Cut-Grooved	Roll-Grooved		
	Sch. 40S	Sch. 40S	Sch. 10S	Sch. 5S
in	psi	psi	psi	psi
mm	Bar	Bar	Bar	Bar
10	600	600	300	200
250	42	42	20	14
12	600	600	300	200
300	42	42	20	14
14	400	400	300	200
350	28	28	20	14
16	400	400	300	200
400	28	28	20	14
18	350	350	300	200
450	24	24	20	14
20	350	350	300	200
500	24	24	20	14
22	300	300	300	200
550	20	20	20	14
24	300	300	300	200
600	20	20	20	14

Model SS-7 Rigid Coupling

Nom. Size	Cut-Grooved	Roll-Grooved		
	Sch. 40S	Sch. 40S	Sch. 10S	Sch. 5S
in	psi	psi	psi	psi
mm	Bar	Bar	Bar	Bar
1 ¼	750	750	500	200
32	52	52	35	14
1 ½	750	750	500	200
40	52	52	35	14
2	600	600	500	200
50	42	42	35	14
2 ½	600	600	500	200
65	42	42	35	14
3	600	600	500	200
80	42	42	35	14
4	600	600	400	200
100	42	42	28	14
5	600	600	350	200
125	42	42	24	14
6	600	400	300	200
150	42	28	20	14
8	600	600	300	200
200	42	42	20	14

Model SS-5 Rigid Coupling

Nom. Size	Cut-Grooved	Roll-Grooved		
	Sch. 40S	Sch. 40S	Sch. 10S	Sch. 5S
in	psi	psi	psi	psi
mm	Bar	Bar	Bar	Bar
1 ¼	600	600	300	200
32	42	42	20	14
1 ½	600	600	300	200
40	42	42	20	14
2	600	600	300	200
50	42	42	20	14
2 ½	600	600	300	200
65	42	42	20	14
3	600	600	300	200
80	42	42	20	14
4	600	600	300	200
100	42	42	20	14
5	600	600	300	200
125	42	42	20	14
6	600	600	300	200
150	42	42	20	14
8	600	600	300	200
200	42	42	20	14

Model SS-8 Flexible Coupling

Nom. Size	Cut-Grooved	Roll-Grooved		
	Sch. 40S	Sch. 40S	Sch. 10S	Sch. 5S
in	psi	psi	psi	psi
mm	Bar	Bar	Bar	Bar
1	500	500	450	225
25	35	35	31	16
1¼	500	500	450	225
32	35	35	31	16
1½	500	500	450	225
40	35	35	31	16
2	500	500	450	225
50	35	35	31	16
2½	500	500	450	225
65	35	35	31	16
3	500	500	450	225
80	35	35	31	16
4	425	425	400	200
100	29	29	28	14
5	425	425	400	125
125	29	29	28	9
6	425	425	400	125
150	29	29	28	9
8	300	300	200	125
200	20	20	14	9

Model SS-1200 High Pressure Flexible Coupling

Nom. Size in / mm	Cut-Grooved	
	Sch. 80S	Sch. 40S
in	psi	psi
mm	Bar	Bar
¾	1200	1200
20	83	83
1	1200	1200
25	83	83
1¼	1200	1200
32	83	83
1½	1200	1200
40	83	83
2	1200	1200
50	83	83
2½	1200	1200
65	83	83
3	1200	1200
80	83	83
4	1200	1200
100	83	83
6	1200	1200
150	83	83
8	1200	1200
200	83	83

Burst pressure: 2 times the listed working pressure.

Model SS-8X Heavy Duty Flexible Coupling

Nom. Size	Cut-Grooved	Roll-Grooved		
	Sch. 40S	Sch. 40S	Sch. 10S	Sch. 5S
in	psi	psi	psi	psi
mm	Bar	Bar	Bar	Bar
¾	750	750	500	200
20	52	52	35	14
1	750	750	500	200
25	52	52	35	14
1¼	750	750	500	200
32	52	52	35	14
1½	750	750	500	200
40	52	52	35	14
2	750	750	500	200
50	52	52	35	14
2½	750	750	500	200
65	52	52	35	14
3	750	750	500	200
80	52	52	35	14
4	750	750	400	200
100	52	52	28	14
5	750	750	400	200
125	52	52	28	14
6	500	500	400	200
150	35	35	28	14
8	425	425	300	200
200	29	29	20	14

Model SS-28 Hinged Lever Coupling

Nom. Size	Cut-Grooved	Roll-Grooved		
	Sch. 40S	Sch. 40S	Sch. 10S	Sch. 5S
in	psi	psi	psi	psi
mm	Bar	Bar	Bar	Bar
1½	300	300	300	200
40	20	20	20	14
2	300	300	300	200
50	20	20	20	14
2½	300	300	300	200
65	20	20	20	14
3	300	300	300	200
80	20	20	20	14
4	300	300	300	200
100	20	20	20	14
5	200	200	200	125
125	14	14	14	9
6	200	200	200	125
150	14	14	14	9

Section 4

Valves & Flow Control Components

Valves & Flow Control Components	106
SJ-200 Low-Profile Butterfly Valve	107
SJ-300N Butterfly Valve	108
SJ-300F Butterfly Valve (for Fire Protection)	110
SJ-500L Ball Valves	111
SJ-500W Ball Valves.....	112
SJ-530 Three Port Ball Valve	112
SJ-900 Swing Check Valve.....	113
SJ-915 Dual Disc Check Valve.....	114
SJ-930 Horizontal Swing Check Valve.....	115
651 Expansion Joint	116
725G Suction Diffuser	117
725F Suction Diffuser (Fabricated)	118
726 Y-Strainer.....	119
728 T-Strainer.....	120
RCV Riser Check Valve (for Fire Protection).....	121
BH-22C Brass Swing Check Valve	121

Valves and Flow Control Components

Shurjoint offers a wide range of grooved-end butterfly valves, ball valves, check valves, suction diffusers, strainers and expansion joints. Grooved-end valves and components can be installed 3 – 4 times faster than comparable flange components. With the removal of just a few bolts one can easily access the system for cleaning, maintenance, changes and or system expansion.

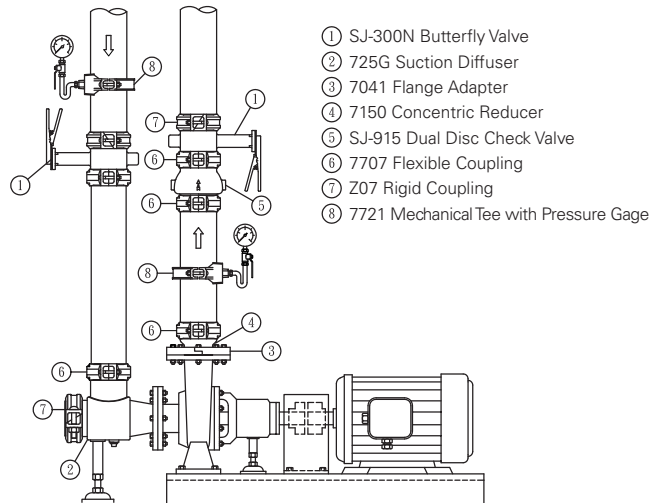
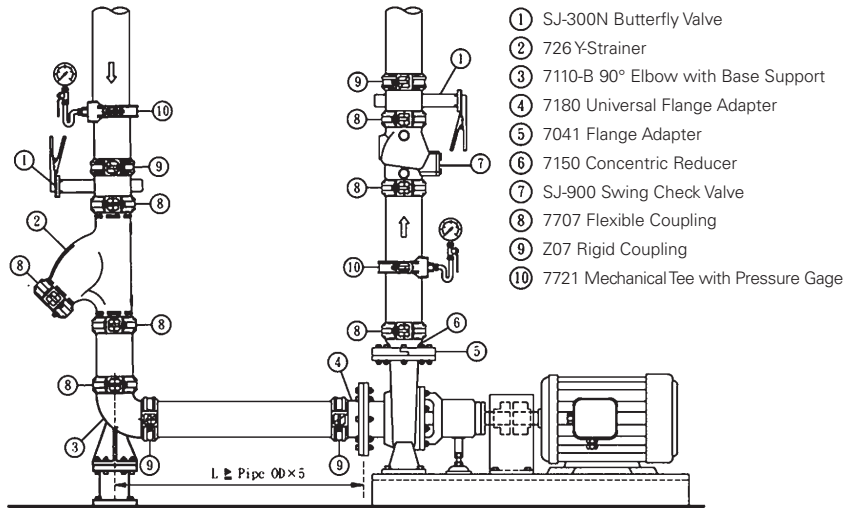

Model
SJ-200 Low-Profile Butterfly Valve

The Shurjoint Model SJ-200 Butterfly Valve is a low profile, grooved-end butterfly valve designed for oil & gas, mining and other service applications. The working pressure is rated up to 232 psi / 1600 kPa and service temperatures are rated to +180°F / +82°C

(Nitrile body liner). The Model SJ-200 features a fully rubber lined body with 316 stainless steel disc. The end to end dimensions conform to MSS SP-67. The lever handle is equipped with a tamper resistant locking device.



Not Recommended for Steam.

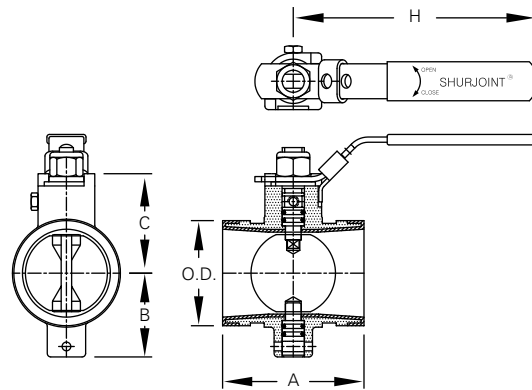

Nominal Size	Pipe O.D.	Max. Working Pressure (CWP)*	Dimensions				Weight
			A	B	C	H	
in	in	PSI	in	in	in	in	Lbs
mm	mm	Bar	mm	mm	mm	mm	Kgs
2	2.375	232	3.19	1.89	2.25	5.51	2.0
50	60.3	16	81	48	57	140	0.9
2½	2.875	232	3.82	2.13	2.65	7.48	3.3
65	73.0	16	97	54	67	190	1.5
3	3.500	232	3.82	2.44	2.94	7.48	4.2
80	88.9	16	97	62	75	190	1.9
4	4.500	232	4.57	3.00	4.19	10.79	8.6
100	114.3	16	116	76	106.3	274	3.9
6	6.625	232	5.83	4.09	5.45	10.79	22.2
150	168.3	16	148	104	138.5	274	10.1
8	8.625	232	5.25	5.50	6.45	10.79	27.9
200	219.1	16	133	140	163.9	274	11.3

* Working pressure is based on connection with roll- or cut-grooved standard wall carbon steel pipe.

Model SJ-300N-L Butterfly Valve

The Shurjoint Model SJ-300N Butterfly Valve is a grooved-end shut-off valve equipped with a 10 position lever handle (SJ-300N-L) or worm gear operator (SJ-300N-W). The valve consists of an epoxy coated ductile iron body and EPDM or Nitrile (NBR) rubber encapsulated dual-seal disc.

The Model SJ-300N is rated up to + 200° F (+93°C) for general service use and is UL classified in accordance with NSF/ANSI 61 and NSF/ANSI 372 for potable water services up to temperature + 180° F (+82°C) with "E-pw" encapsulated disc. The end-to-end dimensions conform to MSS SP-67.



Nominal Size	Pipe O.D.	Max. Working Pressure (CWP)*	Dimensions					Operating Torque	Weight‡
			A	B	C	D	E		
in	in	PSI	in	in	in	in	in	Lbs-in	Lbs
mm	mm	Bar	mm	mm	mm	mm	mm	Nm	Kgs
2	2.375	300	3.19	2.52	2.48	4.17	7.56	80	6.8
50	60.3	20	81	64	63	106	192	9	3.1
2½	2.875	300	3.82	3.11	2.68	4.37	7.56	120	8.2
65	73.0	20	97	79	68	111	192	14	3.7
76.1 mm	3.000	300	3.82	3.11	2.68	4.37	7.56	120	8.4
	76.1	20	97	79	68	111	192	14	3.8
3	3.500	300	3.82	3.62	2.99	4.96	7.56	160	9.0
80	88.9	20	97	92	76	126	192	18	4.1
4	4.500	300	4.57	4.65	3.50	5.32	10.24	450	11.4
100	114.3	20	116	118	89	135	260	51	5.2
139.7 mm	5.500	300	5.83	5.71	4.02	6.61	10.24	700	16.9
	139.7	20	148	145	102	168	260	79	7.7
5	5.563	300	5.83	5.71	4.02	6.61	10.24	700	16.9
125	141.3	20	148	145	102	168	260	79	7.7
165.1 mm	6.500	300	5.83	6.77	4.49	7.24	10.24	900	20.2
	165.1	20	148	172	114	184	260	102	9.2
6	6.625	300	5.83	6.77	4.49	7.24	10.24	900	20.2
150	168.3	20	148	172	114	184	260	102	9.2
200 JIS	8.516	300	5.24	8.74	5.51	8.19	10.24	1200	26.8
	216.3	20	133	222	140	208	260	136	12.2
8	8.625	300	5.24	8.74	5.51	8.19	10.24	1200	26.8
200	219.1	20	133	222	140	208	260	136	12.2
10	10.750	300	6.25	10.86	6.69	9.25	14.02	1800	48.4
250	273.0	20	159	276	170	235	356	204	22.0
12	12.750	300	6.53	12.87	8.07	10.24	14.02	2500	73.7
300	323.9	20	165	327	205	260	356	282	33.5

* Working pressure is based on connection with roll- or cut-grooved standard wall carbon steel pipe.

‡ The weight includes the lever handle.

Notes: The torque values are based on liquid applications. For dry or non-lubricating applications add a 25% service factor to the above values.

Model SJ-300N-W Butterfly Valve

The Model SJ-300N can be equipped with a worm gear operator. The ISO 5211 mounting pad allows for the mounting of power actuators.



SJ-300N-W
w / worm gear

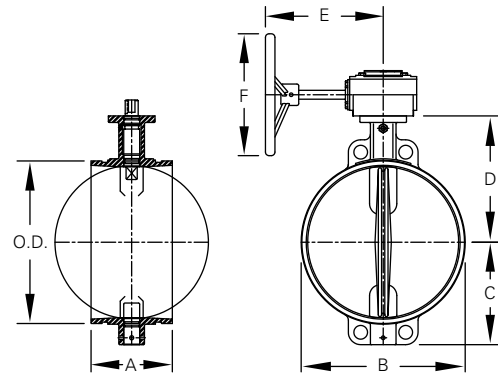

Nominal Size	Pipe O.D.	Max. Working Pressure (CWP)*	Dimensions						Weight‡
			A	B	C	D	E	F	
in	in	PSI	in	in	in	in	in	in	Lbs
mm	mm	Bar	mm	mm	mm	mm	mm	mm	Kgs
2	2.375	300	3.19	2.52	2.48	4.17	6.00	6.00	13.6
50	60.3	20	81	64	63	106	152	152	6.2
2½	2.875	300	3.82	3.11	2.68	4.37	6.00	6.00	14.3
65	73.0	20	97	79	68	111	152	152	6.5
76.1 mm	3.000	300	3.82	3.11	2.68	4.37	6.00	6.00	14.3
	76.1	20	97	79	68	111	152	152	6.5
3	3.500	300	3.82	3.62	2.99	4.96	6.00	6.00	16.0
80	88.9	20	97	92	76	126	152	152	7.3
4	4.500	300	4.57	4.65	3.50	5.32	6.00	6.00	19.1
100	114.3	20	116	118	89	135	152	152	8.7
139.7 mm	5.500	300	5.83	5.71	4.02	6.61	6.00	6.00	21.8
	139.7	20	148	145	102	168	152	152	9.9
5	5.563	300	5.83	5.71	4.02	6.61	6.00	6.00	21.8
125	141.3	20	148	145	102	168	152	152	9.9
165.1 mm	6.500	300	5.83	6.77	4.49	7.24	6.00	6.00	25.0
	165.1	20	148	172	114	184	152	152	11.4
6	6.625	300	5.83	6.77	4.49	7.24	6.00	6.00	25.3
150	168.3	20	148	172	114	184	152	152	11.5
200 JIS	8.516	300	5.24	8.74	5.51	8.19	6.00	6.00	31.9
	216.3	20	133	222	140	208	152	152	14.5
8	8.625	300	5.24	8.74	5.51	8.19	6.00	6.00	32.0
200	219.1	20	133	222	140	208	152	152	14.5
10	10.750	300	6.25	10.86	6.69	9.25	8.00	8.00	59.4
250	273.0	20	159	276	170	235	203	203	27.0
12	12.750	300	6.53	12.87	8.07	10.24	8.00	8.00	73.7
300	323.9	20	165	327	205	260	203	203	33.5
14	14.000	300	7.00	14.37	8.82	10.86	9.50	12.00	130.0
350	355.6	20	178	365	224	276	242	306	59.0
16	16.000	300	7.00	16.38	9.76	11.89	9.50	12.00	147.4
400	406.4	20	178	416	248	302	242	306	67.0
18	18.000	300	8.00	18.50	11.14	13.78	9.50	12.00	189.2
450	457.2	20	203	470	283	350	242	306	86.0
20	20.000	300	8.50	20.75	12.36	15.08	11.50	16.00	292.6
500	508.0	20	216	527	314	383	290	412	133.0
22	22.000	300	9.25	22.75	13.48	16.81	11.50	16.00	324.1
550	559.0	20	235	578	343	427	290	412	147.0
24	24.000	300	10.00	24.76	14.49	17.83	11.50	16.00	352.0
600	609.6	20	254	629	368	453	290	412	160.0

* Working pressure is based on connection with roll- or cut-grooved standard wall carbon steel pipe.

‡ The weight includes the worm gear operator.

Model SJ-300F Butterfly Valve

The Shurjoint Model SJ-300F Butterfly Valve is a grooved-end shut-off valve equipped with a weatherproof worm gear operator and supervisory switch and wiring. The Model SJ-300F is cULus listed and FM approved for 300 psi (20 Bar, 2.0 MPa) WWP (water working pressure) service for indoor and outdoor use. Flow characteristics

satisfy UL Specification 1091 and FM Approval Standard 1112.

When the Model SJ-300F Butterfly Valve is used in a fire protection piping, installation shall conform to NFPA 13 and NFPA 72.

The valve consists of an epoxy powder coated ductile iron body and EPDM rubber encapsulated dual-seal disc.

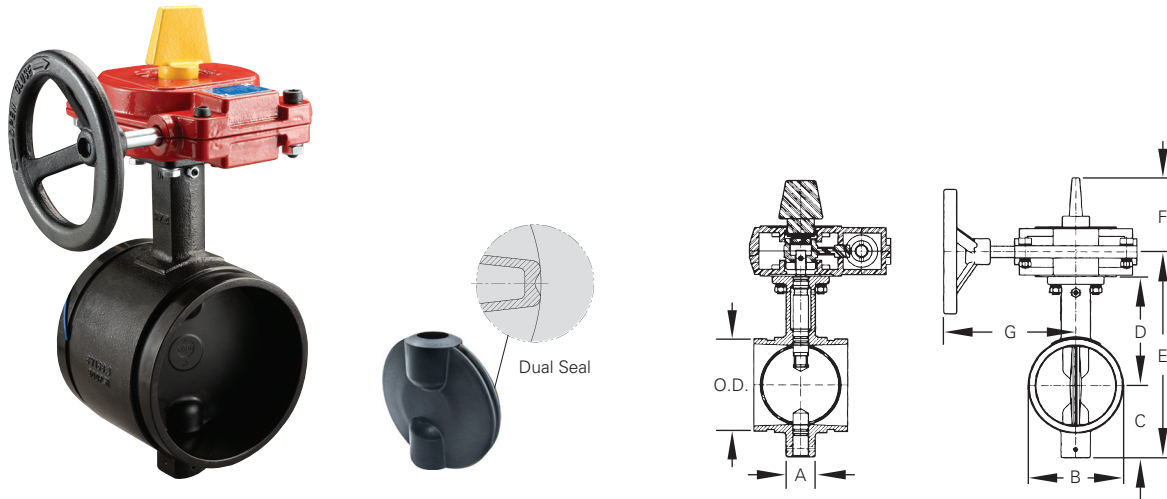

Nominal Size	Pipe O.D.	Max. Working Pressure (CWP)**	Dimensions							Weight ⁽²⁾
			A ⁽¹⁾	B	C	D	E	F	G	
in	in	PSI	in	in	in	in	in	in	in	Lbs
mm	mm	Bar	mm	mm	mm	mm	mm	mm	mm	Kgs
2	2.375	300	3.19	2.56	2.48	4.17	7.87	3.62	6.42	16.70
50	60.3	20	81	65	63	106	200	92	163	7.60
2½	2.875	300	3.81	3.15	2.68	4.37	8.27	3.62	6.42	18.26
65	73.0	20	97	80	68	111	210	92	163	8.30
76.1 mm	3.000	300	3.81	3.15	2.68	4.37	8.27	3.62	6.42	18.41
	76.1	20	97	80	68	111	210	92	163	8.37
3	3.500	300	3.81	3.62	3.00	4.96	9.17	3.62	6.42	18.92
80	88.9	20	97	92	76	126	233	92	163	8.60
4	4.500	300	4.56	4.65	3.50	5.31	10.04	3.62	6.42	21.78
100	114.3	20	116	118	89	135	255	92	163	9.90
139.7 mm	5.500	300	5.81	5.71	4.00	6.61	11.85	3.62	6.42	27.08
	139.7	20	148	145	102	168	301	92	163	12.31
5	5.500	300	5.81	5.71	4.00	6.61	11.85	3.62	6.42	26.84
125	141.3	20	148	145	102	168	301	92	163	12.20
165.1 mm	6.500	300	5.81	6.77	4.50	7.25	12.95	3.62	6.42	30.38
	165.1	20	148	172	114	184	329	92	163	13.81
6	6.625	300	5.81	6.77	4.50	7.25	12.95	3.62	6.42	30.14
150	168.3	20	148	172	114	184	329	92	163	13.70
8	8.625	300	5.24	8.74	5.51	8.19	14.92	3.62	6.42	38.72
200	219.1	20	133	222	140	208	379	92	163	17.60
200 JIS	8.516	300	5.24	8.74	5.51	8.19	14.92	3.62	6.42	38.72
	216.3	20	133	222	140	208	379	92	163	17.60
10	10.750	300	6.25	10.87	6.69	9.25	17.17	3.62	6.42	59.27
250	273.0	20	159	276	170	235	436	92	163	26.88
12	12.750	300	6.50	12.87	8.07	10.24	19.53	3.62	6.42	74.97
300	323.9	20	165	327	205	260	496	92	163	34.00

(1) End to end dimensions conforms to MSS SP-67.

(2) The weight includes the worm gear operator.

* Working pressure is based on connection with roll- or cut-grooved standard wall carbon steel pipe.

‡ For Fire Protection pressure rating, listing, and approval information, please refer to Data Sheet B-42 or visit SHURJOINT website, www.shurjoint.com for details or contact your SHURJOINT Representative.

Model SJ-500L Ball Valve

The Shurjoint Model SJ-500L is a ductile iron, grooved-end, two-piece, regular port ball valve designed and tested in conformance with MSS SP-110 and SP-72. The lever handle is equipped with tamper

resistant locking holes. The SJ-500L is comprised of a ductile iron body and end cap, virgin TFE seats and chrome-plated carbon steel trim. Also available with stainless steel trim as an option.

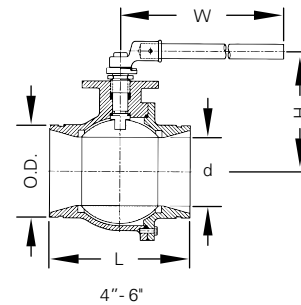
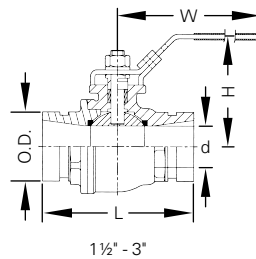

Nominal Size	Pipe O.D.	Max. Working Pressure (CWP)*	Operating Torque‡	Dimensions				Weight
				L	H	W	d	
in	in	PSI	Lbs-in	in	in	in	in	Lbs
mm	mm	Bar	Nm	mm	mm	mm	mm	Kgs
1½	1.900	1000	62	5.12	3.39	7.00	1.25	3.9
40	48.3	69	7	130	86	178	32	1.8
2	2.375	1000	150	5.50	3.75	7.00	1.50	6.4
50	60.3	69	17	140	95	178	38	2.9
2½	2.875	1000	186	6.25	5.20	10.43	2.00	9.7
65	73.0	69	21	159	132	265	50	4.4
76.1 mm	3.000	1000	186	6.25	5.20	10.43	2.00	9.7
	76.1	69	21	159	132	265	50	4.4
3	3.500	1000	248	6.56	5.63	10.43	2.50	17.2
80	88.9	69	28	167	143	265	63	7.8
4	4.500	800	398	9.45	5.31	14.37	3.50	34.5
100	114.3	56	45	240	135	365	90	15.7
165.1 mm	6.500	800	531	10.15	8.70	23.60	4.92	90.2
	165.1	56	60	258	221	600	125	41.1
6	6.625	800	531	10.15	8.70	23.60	4.92	90.2
150	168.3	56	60	258	221	600	125	41.1

* Working pressure is based on connection with roll- or cut-grooved standard wall carbon steel pipe.

‡ For the first opening or closing of the valve when the valve is not continuously operated, an additional torque of 2.0 – 2.5 times the listed operating torque is normally required.

Model

SJ-500W Ball Valve with Gear Operator

The Model SJ-500W can be equipped with a worm gear operator. The standard gear operator is supplied with a bracket and extension sleeve. The ISO 5211 mounting pad allows for the mounting of power actuators.

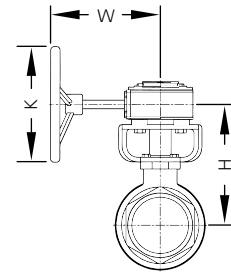

Nominal Size	Pipe O.D.	Max. Working Pressure (CWP)*	Dimensions			Weight
			K	H	W	
in	in	PSI	in	in	in	Lbs
mm	mm	Bar	mm	mm	mm	Kgs
2	2.375	1000	5.98	5.38	5.98	18
50	60.3	69	152	137	152	8
2½	2.875	1000	5.98	5.68	5.98	22
65	73.0	69	152	145	152	10
76.1 mm	3.000	1000	5.98	5.68	5.98	22
	76.1	69	152	145	152	10
3	3.500	1000	5.98	7.16	8.00	168
80	88.9	69	152	182	203	14
4	4.500	800	5.98	8.00	8.00	73
100	114.3	56	152	203	203	33
165.1 mm	6.500	800	12.00	10.89	9.53	123
	165.1	56	305	277	242	56
6	6.625	800	12.00	10.89	9.53	123
150	168.3	56	305	277	242	56

* Working pressure is based on connection with roll- or cut-grooved standard wall carbon steel pipe.

Model

SJ-530 Three Port Ball Valve

The Shurjoint Model SJ-530 is a grooved-end three-port ball valve designed to divert media from bottom inlet to either of the two outlets ports. The valve port is a regular port size and the stem features a

blowout proof design to MSS SP-72 and API Standard 608. The valve body and trim materials are in compliance with NACE MR-01-75 requirements.

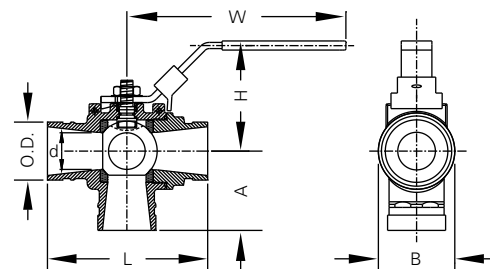

Nominal Size	Pipe O.D.	Max. Working Pressure (CWP)*	Operating Torque‡	Dimensions						Weight
				L	H	W	d	A	B	
in	in	PSI	Lbs-in	in	in	in	in	in	in	Lbs
mm	mm	Bar	Nm	mm	mm	mm	mm	mm	mm	Kgs
2	2.375	600	150	6.55	4.32	8.96	1.50	3.25	3.13	7.89
50	60.3	42	17	167	110	228	38	83	79	3.58

* Working pressure is based on connection with roll- or cut-grooved standard wall carbon steel pipe.

‡ For the first opening or closing of the valve when the valve is not continuously operated, an additional torque of 2.0 - 2.5 times the listed operating torque is normally required.

Model SJ-900 Swing Check Valve

The Shurjoint Model SJ-900 Swing Check Valve is a grooved-end check valve featuring a spring-loaded wide-open clapper and a non-stick leak tight EPDM rubber seal. With

a rated working pressure of 300 psi (20 Bar), the valve can be installed in the horizontal or vertical position (upward flow only). Valves are tested to API 598.

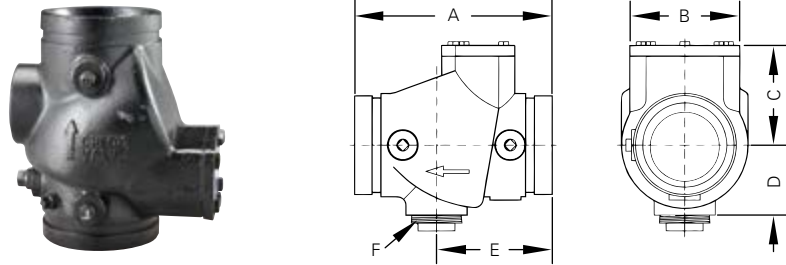

Nominal Size	Pipe O.D.	Max. Working Pressure (CWP)*	Dimensions						Weight
			A	B	C	D	E	F	
in	in	PSI	in	in	in	in	in	in	Lbs
mm	mm	Bar	mm	mm	mm	mm	mm	mm	Kgs
2½	2.875	300	7.48	4.50	3.75	2.50	4.00	1¼"	11.0
65	73.0	20	190	114	95	64	102	NPT	5.0
76.1 mm	3.000	300	7.48	4.50	3.75	2.50	4.00	1¼"	10.8
	76.1	20	190	114	95	64	102	BSP	4.9
3	3.500	300	7.00	4.50	3.75	2.50	4.00	1¼"	10.8
80	88.9	20	178	114	95	64	102	NPT	4.9
4	4.500	300	8.50	5.75	4.60	3.15	5.00	2"	18.3
100	114.3	20	216	146	117	80	127	NPT	8.3
139.7 mm	5.500	300	13.00	8.58	7.00	4.50	7.64	2"	51.7
	139.7	20	330	218	178	114	194	BSP	23.5
5	5.563	300	13.00	8.58	7.00	4.50	7.64	2"	51.7
125	141.3	20	330	218	178	114	194	NPT	23.5
165.1 mm	6.500	300	12.00	8.25	7.00	4.50	7.00	2"	51.7
	165.1	20	305	210	178	114	178	BSP	23.5
6	6.625	300	12.00	8.25	7.05	4.50	7.00	2"	51.7
150	168.3	20	305	210	178	114	178	NPT	23.5
8	8.625	300	14.37	10.47	8.54	5.50	10.00	2"	99.7
200	219.1	20	365	266	217	140	254	NPT	45.3
10	10.750	300	20.00	14.37	10.75	7.25	10.00	2"	217.8
250	273.0	20	508	365	273	184	254	NPT	99.0
12	12.750	300	24.00	15.51	12.87	8.54	12.00	2"	342.3
300	323.9	20	610	394	327	217	305	NPT	155.6
200 JIS	8.516	300	14.37	10.47	8.54	5.50	10.00	2"	99.7
	216.3	20	365	266	217	140	254	BSP	45.3
250 JIS	10.528	300	20.00	14.37	10.75	7.25	10.00	2"	216.7
	267.4	20	508	365	273	184	254	BSP	98.5
300 JIS	12.539	300	24.00	15.51	12.87	8.54	12.00	2"	342.3
	318.5	20	610	394	327	217	305	BSP	155.6

* Working pressure is based on connection with roll- or cut-grooved standard wall carbon steel pipe.

Model SJ-915 Dual Disc Check Valve

The Shurjoint Model SJ-915 is a grooved-end dual-plate (or double-door) check valve designed to provide positive and silent protection against backflow in piping systems. The valve features a ductile iron body with an EPDM or Nitrile (NBR) resilient seat molded to the body and type 304 stainless steel discs loaded with type 313 stainless steel springs.



Size: 2½"~12"

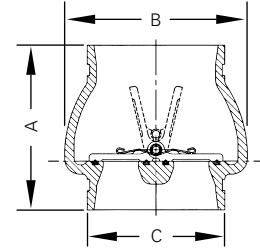

Nominal Size	Pipe O.D.	Max. Working Pressure (CWP)*	Dimensions†			Weight
			A	B	C	
in	in	PSI	in	in	in	Lbs
mm	mm	Bar	mm	mm	mm	Kgs
2½	2.875	300	4.92	4.33	2.87	5.0
65	73.0	20	125	110	73	2.3
3	3.500	300	5.31	4.92	3.50	5.5
80	88.9	20	135	125	89	2.5
4	4.500	300	5.39	5.98	4.50	8.4
100	114.3	20	137	152	114	3.8
6	6.625	300	6.00	8.03	6.62	18.6
150	168.3	20	152	204	168	7.6
8	8.625	300	6.73	10.08	8.62	27.3
200	219.1	20	171	256	219	12.4
10	10.750	300	7.80	12.09	10.75	45.5
250	273.0	20	198	307	273	20.7
12	12.750	300	8.19	14.25	12.75	62.2
300	323.9	20	208	362	324	28.3

* Working pressure is based on connection with roll- or cut-grooved standard wall carbon steel pipe.

† Dimensions are subject to change.

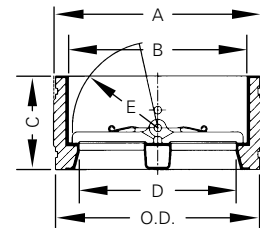
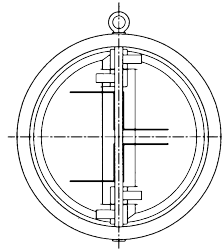

Nominal Size	Pipe O.D.	Max. Working Pressure (CWP)*	Dimensions					Weight
			A	B	C	D	E	
in	in	PSI	in	in	in	in	in	Lbs
mm	mm	Bar	mm	mm	mm	mm	mm	Kgs
14	14.000	300	14.49	12.96	7.13	11.14	6.06	101
350	355.6	20	368	329	181	283	154	46
16	16.000	300	16.14	14.13	7.24	12.20	6.81	119
400	406.4	20	410	359	184	310	173	54
18	18.000	300	18.15	16.42	7.83	14.33	8.00	169
450	457.2	20	461	417	199	364	203	77
20	20.000	300	20.04	18.11	8.46	16.06	8.80	211
500	508.0	20	509	460	215	408	226	96
24	24.000	300	24.00	22.13	9.65	18.00	9.80	288
600	609.6	20	610	562	245	457	249	131

* Working pressure is based on connection with roll- or cut-grooved standard wall carbon steel pipe.

Model

SJ-930 Horizontal Swing Check Valve

The Shurjoint Model SJ-930 horizontal swing check valves are supplied with grooved ends and are designed for general services including mining and oilfield applications. The SJ-930 features a bonnet cap which is drilled, tapped (1/2"

NPT), and plugged and secured using a Shurjoint XH-70EP* coupling. The 316 stainless steel clapper is supplied standard encapsulated with Nitrile. As an option we offer Fluoro-elastomer or Teflon encapsulations to meet your service

requirements.

* SJ-930 in size 4" is equipped with Shurjoint #7771 5" Rigid Coupling.

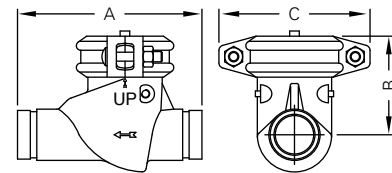

Nominal Size	Pipe O.D.	Max. Working Pressure (CWP)*	Dimensions			Weight
			A	B	C	
in	in	PSI	in	in	in	Lbs
mm	mm	Bar	mm	mm	mm	Kgs
2	2.375	1000	9.00	4.88	5.90	14.5
50	60.3	69	229	124	150	6.6
2½	2.875	1000	9.25	5.50	7.00	22.9
65	73.0	69	235	140	178	10.4
3	3.500	600	10.75	5.75	7.40	26.8
80	88.9	42	273	146	188	12.2
4	4.500	600	12.00	7.63	8.74	38.1
100	114.3	42	305	194	222	17.3
6	6.625	600	16.25	9.15	14.32	103.5
100	168.1	42	413	232.5	363.8	46.9

* Pressure ratings are based on cut-grooved sch. 40 or thicker pipe connected with Shurjoint XH-70EP extra heavy rigid couplings.

Model

651 Expansion Joint

The Model 651 Expansion Joint is a combination of couplings and specially machined pipe nipples that are joined in a series to accommodate the expansion and contraction of a piping system. Standard units are comprised of either Model 7705 or Model 7707 flexible couplings and cut grooved Sch. 40 pipe nipples. Customized

units are also available. The components are epoxy coated (RAL3000 red) for ease of use and longer life. The Model 651 is designed only for use on straight pipe runs and require independent supports and or guides to prevent deflection.

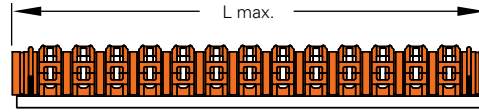
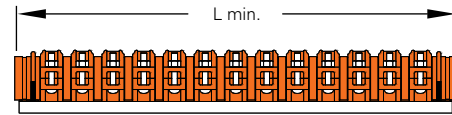
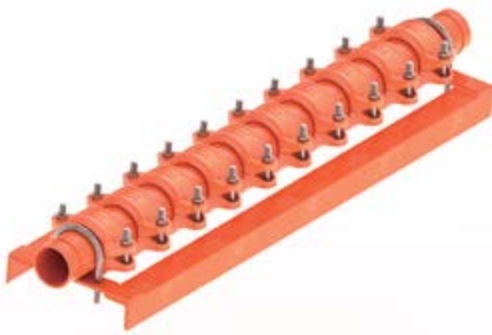

Nominal Size	Pipe O.D.	Couplings (Standard Units †)	Max. Working Pressure (CWP)*	Max. Movement	L - (ref.) §		Weight
					Min. (Compressed)	Max. (Expanded)	
in	in	Model No.	PSI	in	in	in	Lbs
mm	mm	No.	Bar	mm	mm	mm	Kgs
1½	1.900	7705 or 7707	350	2.91	28.25	31.18	24.2
40	48.3	10	24	74	718	792	11.0
2	2.375	7705 or 7707	350	3.11	28.25	31.38	27.0
50	60.3	10	24	79	718	797	12.2
2½	2.875	7705 or 7707	350	3.11	28.25	31.38	36.0
65	73.0	10	24	79	718	797	16.3
76.1 mm	3.000	7705 or 7707	350	3.11	28.25	31.38	36.0
	76.1	10	24	79	718	797	16.3
3	3.500	7705 or 7707	350	3.11	28.25	31.38	46.0
80	88.9	10	24	79	718	797	20.9
4	4.500	7705 or 7707	350	2.09	26.50	28.58	36.5
100	114.3	7	24	53	673	726	16.6
133.0 mm	5.250	7705 or 7707	350	2.09	26.50	28.58	72.0
	133.0	7	24	53	673	726	32.7
165.1 mm	6.500	7705 or 7707	350	2.09	26.26	28.35	58.1
	165.1	7	24	53	667	720	26.4
6	6.625	7705 or 7707	350	2.09	26.26	28.35	91.1
150	168.3	7	24	53	667	720	41.4
8	8.625	7705 or 7707	350	1.93	28.50	30.43	159.7
200	219.1	7	24	49	724	773	72.6
10	10.750	7705 or 7707	350	3.46	33.03	36.46	257.2
250	273.0	7	24	88	839	926	116.9
12	12.750	7705 or 7707	350	3.19	33.31	36.46	373.0
300	323.9	7	24	81	846	926	169.3

* Working pressure is based on connection with roll- or cut-grooved standard wall carbon steel pipe.
 † For Performance Data refer to Data Sheet C-01 for Model 7705 and Data Sheet C-02 for Model 7707.
 Note: Available with greater or less movement by adding or eliminating couplings and nipple units.
 § L - (ref.) Length dimensions may vary slightly due to tolerances.

Model 725G Suction Diffuser

The Shurjoint Model 725G Suction Diffuser features a space saving design, ductile iron body and integral vanes that effectively reduce turbulence and provide optimum flow conditions at the inlet side of the pump.

The suction diffuser's inlet is supplied with a

grooved end to AWWA C606-04. The 725G can be connected directly to grooved end pump or to a flanged end pump if used in combination with a Model 7041 Flange Adapter or a Model 7180 Universal Flange Adapter.

The Model 725G is supplied with a 304

stainless steel running strainer and a disposable fine mesh screen to protect the pump during start-up operation.

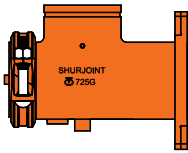
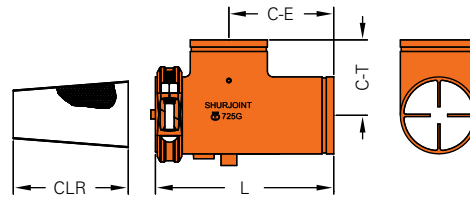

725G + 7041
For Flanged Connection

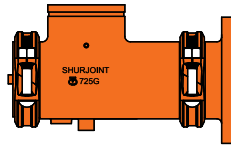

725G + 7180
With a Universal Flange

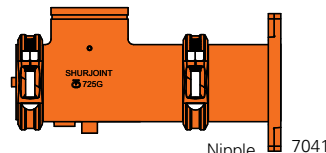

725G + Nipple + 7041
Extension

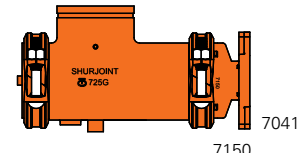

725G + 7150 + 7041
Reduction

Nominal Size		Max. Working Pressure (CWP)*	Dimensions				Drain	Weight
System Side	Pump Side		L	C-E	CLR	C-T		
in	in	PSI	in	in	in	in	in	Lbs
mm	mm	Bar	mm	mm	mm	mm		Kgs
2	2	300	8.82	5.00	5.79	3.75	½	7.9
50	50	20	224	127	147	95	½	3.6
2½	2½	300	8.82	5.00	5.79	3.75	½	8.8
65	65	20	224	127	147	95	½	4.0
3	3	300	10.43	6.30	6.93	5.51	1	13.0
80	80	20	265	160	176	140	1	5.9
4	4	300	12.28	7.36	8.58	5.00	1	20.9
100	100	20	312	187	218	127	1	9.4
5	5	300	13.86	10.24	9.76	9.02	1	38.9
125	125	20	352	260	248	229	1	17.7
6	6	300	15.16	9.02	10.43	6.50	1	43.3
150	150	20	385	229	265	165	1	19.7
8	8	300	18.27	10.24	12.60	9.02	1¼	75.5
200	200	20	464	260	320	229	1¼	34.3
10	10	300	22.11	12.40	16.14	9.02	1¼	123.2
250	250	20	562	315	410	229	1¼	56.0
12	12	300	26.30	15.43	19.29	10.00	1¼	168.1
300	300	20	668	392	490	254	1¼	76.4

* Working pressure is based on connection with roll- or cut-grooved standard wall carbon steel pipe.

Model

725F Suction Diffuser - Fabricated

The Shurjoint Model 725F Suction Diffusers in sizes 14" to 24" (350 mm to 600 mm) are fabricated from carbon steel pipe materials. Flange drilling is available to ANSI Class 150, PN 10/16, BS 10 Table E or JIS 10K.

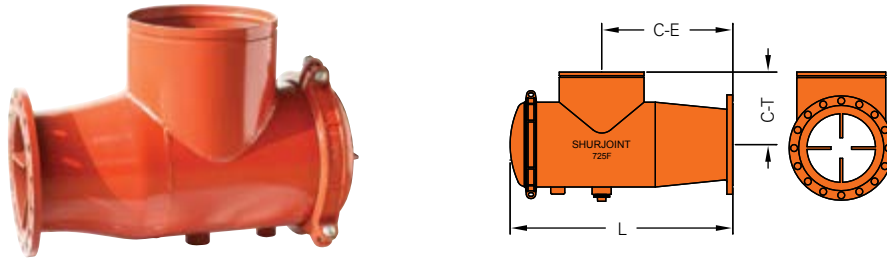

Nominal Size		Max. Working Pressure (CWP)*	Dimensions			Drain	Flange Drilling‡	Weight
Suction Side	Pump Side		L	C-E	C-T			
in	in	PSI	in	in	in	in	Lbs	
mm	mm	Bar	mm	mm	mm		Kgs	
14	10	300	35.00	24.00	14.00	1½" NPT	420	
	250	20	889	610	356		191	
350	12	300	35.00	24.00	14.00		2" NPT	444
	300	20	889	610	356			202
16	14	300	38.00	26.00	16.00	2" NPT		532
	350	20	965	660	406			242
400	12	300	38.00	26.00	16.50		2" NPT	510
	300	20	965	660	419			232
18	14	300	38.00	26.00	16.50	2" NPT		532
	350	20	965	660	419			242
450	16	300	42.00	28.50	17.50		2" NPT	686
	400	20	1067	724	445			312
20	14	300	42.00	28.50	17.50	2" NPT		673
	350	20	1067	724	445			306
500	16	300	42.00	28.50	17.50		2" NPT	686
	400	20	1067	724	445			312
24	18	300	50.00	35.00	20.00	2" NPT		893
	450	20	1270	889	508			406
600	16	300	50.00	35.00	20.00		2" NPT	862
	400	20	1270	889	508			392
550	18	300	54.00	37.00	20.50	2" NPT		893
	450	20	1372	940	521			406
550	20	300	53.00	36.50	23.50		2" NPT	1195
	500	20	1346	927	597			543
550	18	300	54.00	37.00	20.50	2" NPT		1217
	450	20	1372	940	521			553
550	20	300	54.00	37.00	20.50		2" NPT	1256
	500	20	1372	940	521			571
550	22	300	63.00	43.50	23.88	2" NPT		1494
	550	20	1600	1105	606			679

* Working pressure is based on connection with roll- or cut-grooved standard wall carbon steel pipe.

‡ When ordering, specify the desired flange drilling.

Model 726 Y-Strainer

The Shurjoint Model 726 Grooved-end Y-Strainers are designed to strain foreign matter and debris from piping systems and provide inexpensive protection for costly pumps, meters and other pipeline

components. The Model 726 features a low pressure drop, fast installation, easy maintenance and is suitable for either vertical or horizontal installation.

Standard Screen: 1/16" (1.6 mm) perforated

for 2" – 3" sizes and 1/8" (3.2 mm) perforated for 4" – 16". Other customized screen perforations are also available upon request.

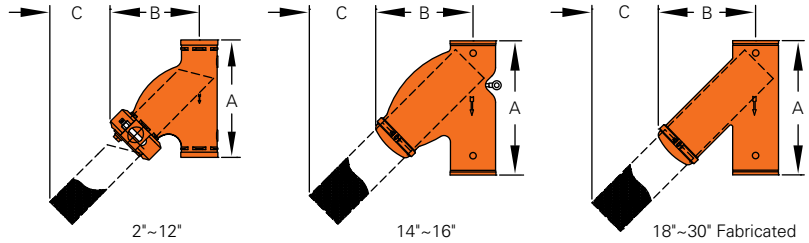

Nominal Size	Pipe O.D.	Max. Working Pressure (CWP)**	Dimensions			Drain Plug Size	Weight
			A	B	C		
in	in	PSI	in	in	in	in	Lbs
mm	mm	Bar	mm	mm	mm	mm	Kgs
2	2.375	300	9.75	7.13	4.56	½	9.3
50	60.3	20	248	181	116	15	4.2
2½	2.875	300	10.75	7.83	4.80	½	13.2
65	73.0	20	273	199	122	15	6.0
76.1 mm	3.000	300	10.75	7.83	4.80	½	13.2
	76.1	20	273	199	122	15	6.0
3	3.500	300	11.75	8.70	5.08	1	16.2
80	88.9	20	299	221	129	25	7.6
4	4.500	300	14.25	10.59	6.61	1	26.4
100	114.3	20	362	269	168	25	12.0
139.7 mm	5.500	300	16.50	13.00	10.16	1	48.4
	139.7	20	419	330	258	25	22.0
5	5.563	300	16.50	13.00	10.16	1	48.4
125	141.3	20	419	330	258	25	22.0
6	6.625	300	18.50	14.05	8.62	1	65.4
150	168.3	20	470	357	219	25	29.7
165.1 mm	6.500	300	18.50	14.05	8.62	1	65.0
	165.1	20	470	357	219	25	29.5
8	8.625	232	24.00	17.87	11.18	1½	121.0
200	219.1	16	610	454	284	40	55.0
10	10.750	175	27.00	20.55	12.60	1½	182.6
250	273.0	12	686	522	320	40	83.0
12	12.750	175	30.00	24.00	14.40	1½	277.2
300	323.9	12	762	609	366	40	126.0
200 JIS	8.516	232	24.00	17.87	11.18	1½	121.0
	216.3	16	610	454	284	40	55.0
250 JIS	10.528	175	27.00	20.55	12.60	1½	182.6
	267.4	12	686	522	320	40	83.0
300 JIS	12.539	175	30.00	24.00	14.40	1½	277.2
	318.5	12	762	609	366	40	126.0
14	14.000	175	40.00	29.92	18.90	1¼	418.0
350	355.6	12	1016	760	480	32	190.0
16	16.000	175	42.00	30.60	19.00	1¼	495.0
400	406.4	12	1067	777	483	32	225.0

** Working pressure is based on connection with roll- or cut-grooved standard wall carbon steel pipe.

Model 728 T-Strainer

The Shurjoint Model 728 Grooved-end T-Strainers are designed to strain foreign matter and debris from piping systems and provide inexpensive protection for costly pumps, meters and other pipeline components. The Model 728 features a low pressure drop, fast installation, easy maintenance and is suitable for either

vertical or horizontal installation. The Model 728 installs with two Shurjoint couplings, and is rated up to 750 psi (52 Bar) depending upon the installed coupling's pressure rating and size. Standard Screen: Mesh 12 for sizes 2" – 3" and mesh 6 for sizes 4" – 14".

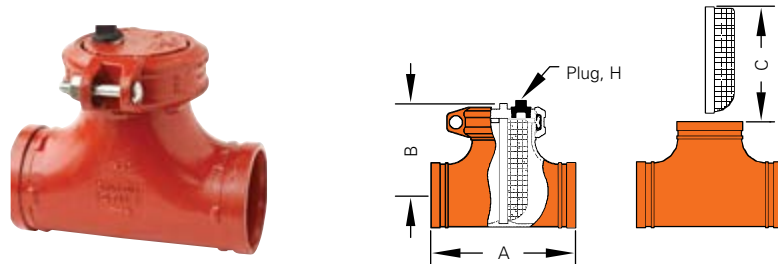

Nominal Size	Pipe O.D.	Max. Working Pressure (CWP)*	Dimensions			H (Drain Plug)	Weight
			A	B	C		
in	in	PSI	in	in	in	in	Lbs
mm	mm	Bar	mm	mm	mm	mm	Kgs
2	2.375	750	6.54	4.72	4.92	½	6.6
50	60.3	52	166	120	125	15	3.0
2½	2.875	750	7.50	5.19	5.59	½	8.8
65	73.0	52	191	132	142	15	4.0
3	3.500	750	8.50	5.74	6.45	½	13.2
80	88.9	52	216	146	164	15	6.0
4	4.500	750	10.00	6.49	7.48	1	17.7
100	114.3	52	254	165	190	25	8.0
5**	5.563	750	11.00	7.48	8.58	1	28.6
125	141.3	52	279	190	218	25	13.0
6	6.625	700	13.00	8.34	10.23	1	44.0
150	168.3	48	330	212	260	25	20.0
8	8.625	600	15.50	9.96	12.60	1½	77.0
200	219.1	42	394	253	320	40	35.0
10	10.750	500	18.00	11.18	14.96	1½	114.6
250	273.0	35	457	284	380	40	52.0
12	12.750	400	20.00	12.16	16.92	1½	160.3
300	323.9	28	508	309	430	40	72.7
14	14.000	250	22.00	17.75	21.25	1½	186.3
350	355.6	17	559	451	540	40	84.5

* 1) Working pressure is based on connection with roll- or cut-grooved standard wall carbon steel pipe.

2) Working pressure is maximum based on Shurjoint Model Z07 access coupling and will be governed by couplings used for installation and related system components. Maximum differential pressure from inlet to outlet must not exceed 10 psi (0.69 Bar).

3) Working pressure is dependent upon the Shurjoint coupling used to join Model 728 to the piping system.

** Non-standard/stock items may require longer lead time.



The T-strainer shall be cleaned periodically or before the differential pressure reaches 10 psi.

Model RCV Riser Check Valve

The **Shurjoint** Model RCV is a grooved-end ductile iron body check valve, designed for use in the risers of wet type fire protection systems. The single clapper design features dual springs for non-slamming operation and the streamlined body provides for low friction loss. The valve can be installed in the vertical or horizontal position. Valves are tested to UL 312.

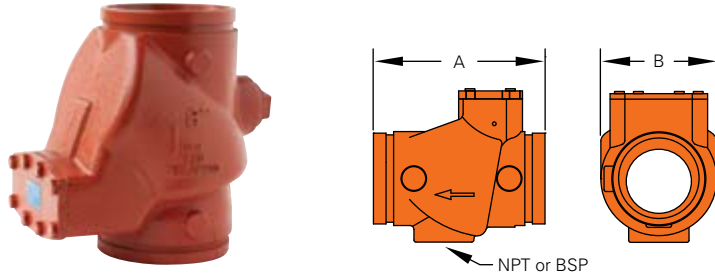

Nominal Size	Pipe O.D.	Max. Working Pressure (CWP)**	Dimensions			Weight
			A	B	Drain (NPT or BSP)	
in	in	PSI	in	in	in	Lbs
mm	mm	Bar	mm	mm		Kgs
2½	2.875	300	7.48	4.50	1¼	10.96
65	73.0	20	190	114	1¼	4.98
76.1 mm	3.000	300	7.48	4.50	1¼	11.29
	76.1	20	190	114	1¼	5.13
3	3.500	300	7.00	4.50	1¼	10.98
80	88.9	20	178	114	1¼	4.99
4	4.500	300	8.50	5.75	2	18.68
100	114.3	20	216	146	2	8.49
	5.500	300	13.00	8.25	2	51.35
139.7 mm	139.7	20	330	210	2	23.34
	5.563	300	13.00	8.25	2	52.36
125	141.3	20	330	210	2	23.80
165.1 mm	6.500	300	12.00	8.25	2	50.23
	165.1	20	305	210	2	22.83
6	6.625	300	12.00	8.25	2	50.82
	168.3	20	305	210	2	23.10

* Working pressure is based on connection with roll- or cut-grooved standard wall carbon steel pipe.

† For Fire Protection pressure rating, listing, and approval information, please refer to Data Sheet B-42 or visit SHURJOINT website, www.shurjoint.com for details or contact your SHURJOINT Representative.

Model BH-22C Brass Swing Check Valve

Grooved-end, Spring Loaded Clapper

The **Shurjoint** Model BH-22C swing check valve is designed for grooved inlet and outlet connections, featuring a brass body with spring-loaded clapper with rubber seat, rated 250 psi (17 bar) working water pressure and suitable for installation in the horizontal or vertical position (upward flow only). The valve body, end piece and clapper are made of brass castings per ASTM A-584 copper alloy C85700.

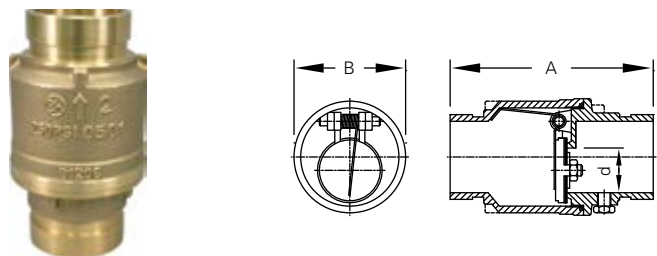

Nominal Size	Pipe O.D.	Max. Working Pressure (CWP)*	Dimensions			Weight
			A	B	d	
in	in	PSI	in	in	in	Lbs
mm	mm	Bar	mm	mm	mm	Kgs
2	2.375	250	5.70	3.25	1.38	3.5
50	60.3	17	145	83	35	1.6
2½	2.875	250	6.50	4.21	1.88	6.8
65	73.0	17	165	107	48	3.1
3	3.500	250	7.64	4.88	2.44	9.9
80	88.9	17	194	124	62	4.5
4	4.500	250	7.95	5.59	3.31	11.9
100	114.3	17	202	142	84	5.4

*Working pressure is based on connection with roll- or cut-grooved standard wall carbon steel pipe.

Section 5

Threaded Fittings & Welding Outlets

Threaded Fittings & Welding Outlets	126
Threaded Fittings	
811 / 812 / 813 / 814 Elbows & Tee	127
815 Tee	128
816 / 817 / 818 Cross & Coupling.....	129
819 / 820 / 825 / 827 / 831 / 832 Plug, Cap, Extension Piece, Hex Bushing, Elbow & Tee	130
830 / 841 Union & Companion Flange.....	131
Top Beam Clamp	
B20 / B24 Beam Clamps	132
Welding Outlets	
71 Threaded Outlet	133
72C / 72R Welding Outlet	134

Threaded Fittings & Welding Outlets

Shurjoint offers a complete range of ductile iron Class 300 threaded fittings in sizes from 1/2" to 2 1/2" (15 mm to 65 mm). **Shurjoint** ductile iron threaded fittings are 100% air tested underwater to ensure leak-free performance. The **Shurjoint** ductile iron fitting series is UL listed and FM approved, making them the right choice for fire protection and other general application services.



Ductile Iron Class 300 threaded fittings are designed to the same basic dimensions as that of Class 150 malleable iron fittings. Though due to the superior strength characteristics, ductile iron fittings carry a much higher pressure rating. Laboratory tests confirm **Shurjoint** ductile iron fittings have passed hydrostatic test pressures exceeding 6,000 psi (414 Bar), which is equal to four times the 1,500 psi (103 Bar) as specified by ANSI B16.3 for 1 1/4" – 2" (32 mm – 50 mm) sizes.

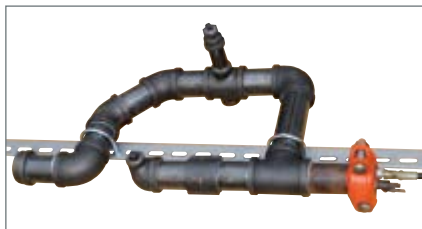

Burst pressure testing of DI threaded fittings (2')

Pressure-Temperature Rating (ANSI B16.3 & B16.14)

Nom. Rating	Working Pressure (W.O.G.) @ 150°F / @ 65°C	Working Pressure Saturated Steam
Class 300	1/2" – 1" : 2000 psi / 140 Bar 1 1/4" – 2" : 1500 psi / 105 Bar 2 1/2" : 1000 psi / 70 Bar	300 psi (20 Bar)

*Proof test pressure: 1.5 times the working pressure, non-shock cold water.

Pressure-Temperature Rating Unions, Brass to Iron Seat (ANSI B16.39)

Nom. Rating	Working Pressure (W.O.G.) @ 150°F / @ 65°C	Working Pressure Saturated Steam
Class 300	600 psi / 42 Bar	300 psi (20 Bar)

*Proof test pressure: 1.5 times the working pressure, non-shock cold water.

*Max. Temperature: 450°F (ASME Boiler Code)

Pressure-Temperature Rating Companion Flanges (ANSI B16.42)

Nom. Rating	Working Pressure (W.O.G.) @ 150°F / @ 65°C	Working Pressure Saturated Steam
Class 150	250 psi / 17 Bar	150 psi (10 Bar)

*Proof test pressure: 1.5 times the working pressure, non-shock cold water.

Material: Ductile iron ASTM A536 Gr. 65-45-12

Dimensions: ANSI B16.3 Class 150 except bushings and plugs (B16.14), unions (B16.39) and companion flanges (B16.42) Please note wall thickness dimensions are subordinate to **Shurjoint** UL and FM pressure rating listings and approvals.

Threads: ANSI B1.20.1 NPT or ISO 7 (BSPT)

Finish: Black or hot-dip galv

Welding Outlets

Shurjoint welding outlets provide an easy branch outlet at any desired location along the header pipe. Available in a variety of size and configurations including threaded, cut grooved and roll grooved ends. Welding outlets are UL listed and FM approved for fire protection applications.

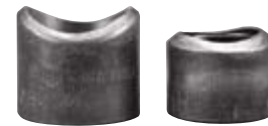

Pressure-Temperature Rating

Nom. Rating	Working Pressure (W.O.G.) @ 150°F / @ 65°C	Working Pressure Saturated Steam
Class 300	600 psi / 42 Bar	300 psi (20 Bar)

*Proof test pressure: 1.5 times the working pressure, non-shock cold water.

*Burst test pressure: Minimum 3 times the working pressure.

General Dimensions

These dimensions apply to all standard fittings, both straight and reducing. For center-to-face dimensions(*), see fitting tables.

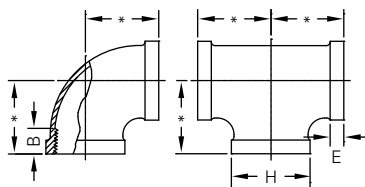

Pipe Size	H Band O.D.	E Band Width	B Thread Length (min)
in	in	in	in
mm	mm	mm	mm
1/2	1.02	0.25	0.43
15	26	6	11
3/4	1.46	0.27	0.5
20	37	7	13
1	1.77	0.3	0.58
25	45	8	15
1 1/4	2.15	0.34	0.67
32	55	9	17
1 1/2	2.43	0.37	0.7
40	62	9	18
2	2.96	0.42	0.75
50	75	11	19
2 1/2	3.59	0.48	0.92
65	91	12	23

Model 811 90° Elbow

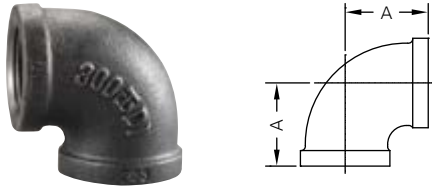

Size	Pipe O.D.	A	Weight	Box Q'ty
in	in	in	Lbs	
mm	mm	mm	Kgs	Pcs
½	0.840	1.12	0.25	240
15	21.3	28	0.1	
¾	1.050	1.31	0.35	120
20	26.7	33	0.2	
1	1.315	1.50	0.57	70
25	33.4	38	0.3	
1¼	1.660	1.75	0.97	40
32	42.2	44	0.4	
1½	1.900	1.94	1.17	30
40	48.3	49	0.5	
2	2.375	2.25	1.83	20
50	60.3	57	0.8	
2½	2.875	2.70	3.34	10
65	73.0	69	1.5	

Model 813 45° Elbow

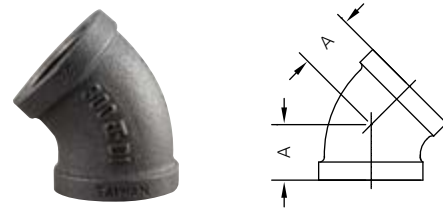

Size	Pipe O.D.	A	Weight	Box Q'ty
in	in	in	Lbs	
mm	mm	mm	Kgs	Pcs
½	0.840	0.88	0.22	250
15	21.3	22	0.1	
¾	1.050	0.98	0.33	150
20	26.7	25	0.1	
1	1.315	1.12	0.55	90
25	33.4	28	0.2	
1¼	1.660	1.29	0.84	50
32	42.2	33	0.4	
1½	1.900	1.43	0.92	35
40	48.3	36	0.4	
2	2.375	1.68	1.63	18
50	60.3	43	0.7	
2½	2.875	1.95	2.42	12
65	73.0	50	1.1	

Model 812 Reducing 90° Elbow

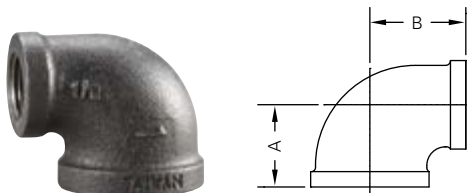

Size	Pipe O.D.	A	B	Weight	Box Q'ty
in	in	in	in	Lbs	
mm	mm	mm	mm	Kgs	Pcs
¾ x ½	1.050 x 0.840	1.20	1.22	0.35	160
20 x 15	26.7 x 21.3	30	31	0.2	
1 x ½	1.315 x 0.840	1.26	1.36	0.46	110
25 x 15	33.4 x 21.3	32	35	0.2	
1 x ¾	1.315 x 1.050	1.18	1.45	0.57	90
25 x 20	33.4 x 26.7	30	37	0.3	
1¼ x ½	1.660 x 0.840	1.34	1.53	0.64	75
32 x 15	42.2 x 21.3	34	39	0.3	
1¼ x ¾	1.660 x 1.050	1.45	1.62	0.68	60
32 x 20	42.2 x 26.7	37	41	0.3	
1¼ x 1	1.660 x 1.315	1.58	1.67	0.81	55
32 x 25	42.2 x 33.4	40	42	0.4	
1½ x ½	1.900 x 0.840	1.41	1.66	0.84	45
40 x 15	48.3 x 21.3	36	42	0.4	
1½ x ¾	1.900 x 1.050	1.52	1.75	0.90	45
40 x 20	48.3 x 26.7	39	44	0.4	
1½ x 1	1.900 x 1.315	1.65	1.80	0.95	40
40 x 25	48.3 x 33.4	42	46	0.4	
1½ x 1¼	1.900 x 1.660	1.82	1.88	1.10	35
40 x 32	48.3 x 42.2	46	48	0.5	
2 x ¾	2.375 x 1.050	1.60	1.97	1.19	30
50 x 20	60.3 x 26.7	41	50	0.5	
2 x 1	2.375 x 1.315	1.73	2.02	1.47	25
50 x 25	60.3 x 33.4	44	51	0.7	
2 x 1½	2.375 x 1.900	2.02	2.16	1.61	20
50 x 40	60.3 x 48.3	51	55	0.7	
2½ x 2	2.875 x 2.375	2.39	2.60	2.93	15
65 x 50	73.0 x 60.3	61	66	1.3	

Model 814 Tee

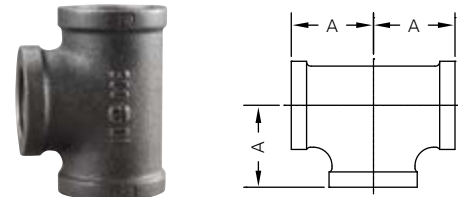

Size	Pipe O.D.	A	Weight	Box Q'ty
in	in	in	Lbs	
mm	mm	mm	Kgs	Pcs
½	0.840	1.12	0.31	150
15	21.3	28	0.1	
¾	1.050	1.31	0.48	90
20	26.7	33	0.2	
1	1.315	1.50	0.81	60
25	33.4	38	0.4	
1¼	1.660	1.75	1.28	35
32	42.2	44	0.6	
1½	1.900	1.94	1.72	24
40	48.3	49	0.8	
2	2.375	2.25	2.57	12
50	60.3	57	1.2	
2½	2.875	2.70	4.44	8
65	73.0	69	2.0	

Model

815 Reducing Tee

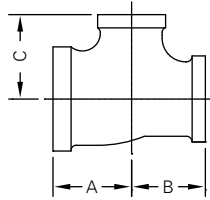

Size			A	B	C	Weight	Box Qty
in mm			in mm	in mm	in mm	Lbs Kgs	Pcs
3/4	20	3/4	1.20	1.20	1.22	0.46	95
		1/2	1.20	1.20	1.22	0.46	
1	25	1/2	1.50	1.36	1.50	0.71	55
		3/4	1.50	1.36	1.50	0.71	
1	25	15	38	35	38	0.3	80
		20	32	30	35	0.3	
1	25	3/4	1.37	1.31	1.45	0.66	65
		1	1.50	1.45	1.50	0.77	
1	25	25	38	37	38	0.3	55
		32	44	42	44	0.6	
1	25	1/2	1.26	1.26	1.36	0.64	65
		3/4	1.37	1.37	1.45	0.75	
1	25	15	32	32	35	0.3	60
		20	35	35	37	0.3	
1 1/4	32	1/2	1.34	1.26	1.53	0.79	50
		3/4	1.45	1.37	1.62	0.88	
1 1/4	32	15	34	32	39	0.4	50
		20	37	35	41	0.4	
1 1/4	32	1	1.58	1.50	1.67	1.01	45
		25	40	38	42	0.2	
1 1/4	32	1 1/4	1.75	1.67	1.75	1.25	40
		20	37	35	41	0.4	
1 1/4	32	1/2	1.34	1.34	1.53	0.84	45
		3/4	1.45	1.45	1.62	0.99	
1 1/4	32	15	34	34	39	0.4	45
		20	37	37	41	0.4	
1 1/4	32	1	1.58	1.58	1.67	1.12	40
		25	40	40	42	0.5	
1 1/4	32	1/2	1.44	1.31	1.69	0.92	40
		3/4	1.50	1.37	1.75	1.01	
1 1/4	32	20	38	35	44	0.5	40
		25	42	38	46	0.5	
1 1/4	32	1 1/4*	1.82	1.67	1.88	1.54	30
		32	46	42	48	0.7	
1 1/4	32	1 1/2	1.94	1.80	1.94	1.54	30
		40	49	46	49	0.7	
1 1/2	40	1/2	1.41	1.34	1.66	1.08	40
		3/4	1.52	1.45	1.75	1.14	
1 1/2	40	15	36	34	42	0.5	40
		20	39	37	44	0.5	
1 1/2	40	1	1.65	1.58	1.80	1.39	30
		25	42	40	46	0.6	
1 1/2	40	1/2	1.41	1.41	1.66	1.10	35
		3/4	1.52	1.45	1.75	1.17	
1 1/2	40	15	36	36	42	0.5	35
		20	39	39	44	0.5	
1 1/2	40	1	1.65	1.65	1.80	1.36	30
		25	42	42	46	0.6	
1 1/2	40	1 1/4	1.82	1.82	1.88	1.56	30
		32	46	46	48	0.7	

Size			A	B	C	Weight	Box Qty
in mm			in mm	in mm	in mm	Lbs Kgs	Pcs
1	25	1	2.25	2.02	2.25	2.13	15
		2	2.25	2.10	2.25	2.22	
1 1/4	32	1 1/4	2.25	2.10	2.25	2.22	15
		2	2.25	2.10	2.25	2.22	
1 1/2	40	1/2	1.49	1.41	1.88	1.52	30
		3/4	1.60	1.52	1.97	1.47	
1 1/2	40	15	38	36	48	0.7	25
		20	41	39	50	0.7	
1 1/2	40	1	1.73	1.65	2.02	1.63	20
		25	44	42	51	0.7	
1 1/2	40	1 1/2	2.02	1.94	2.16	2.09	20
		2	2.25	2.16	2.25	2.33	
1 1/2	40	15	38	38	48	0.7	20
		20	41	41	50	0.7	
1 1/2	40	1	1.73	1.73	2.02	1.80	20
		25	44	44	51	0.8	
1 1/2	40	1 1/4	1.90	1.90	2.10	2.09	20
		32	48	48	53	0.9	
1 1/2	40	1 1/2	2.02	2.02	2.16	2.24	15
		2	2.25	2.16	2.25	2.33	
2 1/2	65	2	1.74	1.60	2.32	2.35	15
		20	44	41	59	1.1	

*Non-standard/stock items may require longer lead time.

Model

815 Bullhead Tee

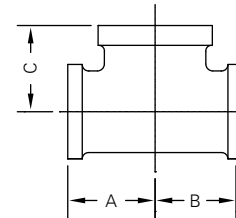

Size			A	B	C	Weight	Box Qty
in mm			in mm	in mm	in mm	Lbs Kgs	Pcs
3/4	20	3/4	1.45	1.45	1.37	0.66	65
		1	1.58	1.58	1.58	0.97	
1	25	1/2	1.81	1.81	1.65	1.15	35
		3/4	1.81	1.81	1.65	1.15	
1	25	1	1.88	1.81	1.82	1.43	30
		25	48	46	46	0.6	
1 1/4	32	1/2	1.88	1.88	1.82	1.52	30
		3/4	1.88	1.88	1.82	1.52	
1 1/4	32	1 1/4	1.88	1.88	1.82	1.52	30
		2	2.10	2.10	1.90	1.80	
1 1/2	40	1/2	1.88	1.81	1.82	1.43	24
		3/4	1.88	1.81	1.82	1.43	
1 1/2	40	1	2.10	2.10	1.90	1.80	20
		25	53	53	48	0.8	
1 1/2	40	1 1/4	2.10	2.10	2.02	1.94	20
		2	2.16	2.16	2.02	2.00	
2	50	1 1/2	2.16	2.16	2.02	2.00	20
		2 1/2	2.60	2.60	2.39	3.61	
2	50	2	2.60	2.60	2.39	3.61	10
		2 1/2	2.60	2.60	2.39	3.61	

Model 816 Reducing Coupling

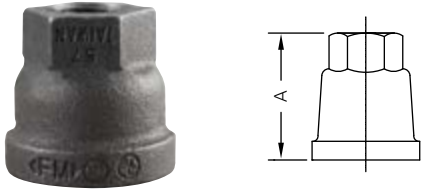

Size	Pipe O.D.	A	Wrench Size	Weight	Box Qty
in mm	in mm	in mm	in mm	Lbs Kgs	Pcs
¾ x ½	1.050 x 0.840	1.63	1¼	0.37	150
20 x 15	26.7 x 21.3	41	32	0.2	
1 x ½	1.315 x 0.840	1.69	1¼	0.37	140
25 x 15	33.4 x 21.3	43	32	0.2	
1 x ¾	1.315 x 1.050	1.37	1½	0.48	120
25 x 20	33.4 x 26.7	35	38	0.2	
1¼ x ¾	1.660 x 1.050	2.06	1½	0.59	80
32 x 20	42.2 x 26.7	52	38	0.3	
1¼ x 1	1.660 x 1.315	2.06	-	0.66	60
32 x 25	42.2 x 33.4	52	-	0.3	
1½ x 1	1.900 x 1.315	2.31	-	0.84	50
40 x 25	48.3 x 33.4	59	-	0.4	
1½ x 1¼	1.900 x 1.660	2.31	-	0.92	45
40 x 32	48.3 x 42.2	59	-	0.4	
2 x 1	2.375 x 1.315	2.81	-	1.23	35
50 x 25	60.3 x 33.4	71	-	0.6	
2 x 1¼	2.375 x 1.660	2.81	-	1.28	30
50 x 32	60.3 x 42.2	71	-	0.6	
2 x 1½	2.375 x 1.900	2.81	-	1.66	30
50 x 40	60.3 x 48.3	71	-	0.8	
2½ x 2	2.875 x 2.375	3.25	-	2.24	18
65 x 50	73.0 x 60.3	83	-	1.0	

Model 818 Straight Coupling

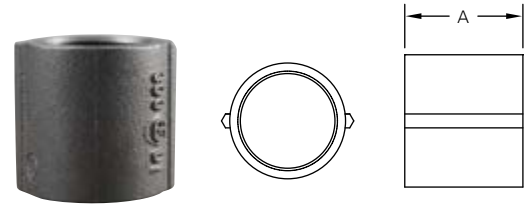

Size	Pipe O.D.	A	Wrench Size	Weight	Box Qty
in mm	in mm	in mm	in mm	Lbs Kgs	Pcs
½	0.840	1.38	1½	0.18	360
15	21.3	35	29	0.1	
¾	1.050	1.61	1¾	0.26	200
20	26.7	41	35	0.2	
1	1.315	1.77	1 ¹¹ / ₁₆	0.42	110
25	33.4	45	43	0.2	
1¼	1.660	2.00	2	0.57	75
32	42.2	51	51	0.3	
1½	1.900	2.20	2¼	0.77	60
40	48.3	56	57	0.3	
2	2.375	2.60	2¾	1.17	30
50	60.3	66	70	0.5	
2½	2.875	3.00	3¾	2.11	18
65	73.0	76	86	1.0	

Model 817 Cross / Reducing Cross

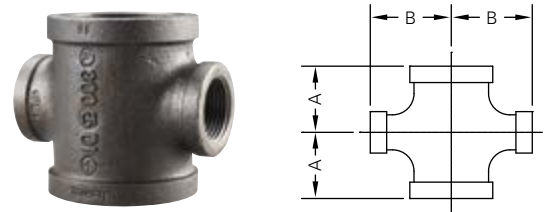
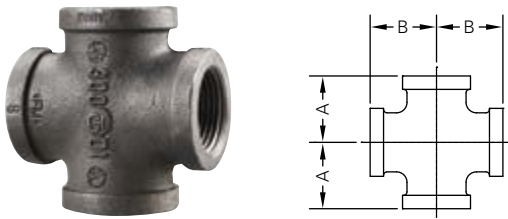

Model 817 Cross

Size	Pipe O.D.	A	B	Weight	Box Qty
in mm	in mm	in mm	in mm	Lbs Kgs	Pcs
½	0.840	1.12	1.12	0.48	90
15	21.3	28	28	0.2	
¾	1.050	1.31	1.31	0.77	60
20	26.7	33	33	0.3	
1	1.315	1.50	1.50	0.95	45
25	33.4	38	38	0.4	
1¼	1.660	1.75	1.75	1.43	25
32	42.2	44	44	0.6	
1½	1.900	1.94	1.94	1.87	20
40	48.3	49	49	0.8	
2	2.375	2.25	2.25	2.86	10
50	60.3	57	57	1.3	

Model 817 Reducing Cross

Size	A	B	Weight	Box Qty
in mm	in mm	in mm	Lbs Kgs	Pcs
1¼ x 1¼ x 1 x 1	1.58	1.67	1.25	30
32 x 32 x 25 x 25	40	42	0.6	
1½ x 1½ x 1 x 1	1.65	1.80	1.47	24
40 x 40 x 25 x 25	42	46	0.7	
2 x 2 x 1 x 1	1.73	2.02	1.94	16
50 x 50 x 25 x 25	44	51	0.9	

Model 819 Plug

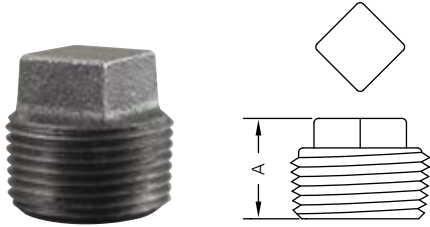

Size	Pipe O.D.	A	Weight	Box Q'ty
in	in	in	Lbs	Pcs
mm	mm	mm	Kgs	
½	0.840	0.93	0.09	500
15	21.3	24	0.0	
¾	1.050	1.13	0.18	300
20	26.7	29	0.1	
1	1.315	1.25	0.25	200
25	33.4	32	0.1	
1½	1.660	1.36	0.42	110
32	42.2	35	0.2	
1½	1.900	1.45	0.59	80
40	48.3	37	0.3	
2	2.375	1.50	0.95	45
50	60.3	38	0.4	

Model 820 Cap

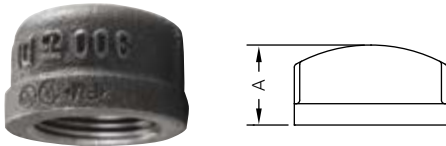

Size	Pipe O.D.	A	Weight	Box Q'ty
in	in	in	Lbs	Pcs
mm	mm	mm	Kgs	
½	0.840	0.89	0.14	500
15	21.3	23	0.1	
¾	1.050	1.00	0.20	300
20	26.7	25	0.1	
1	1.315	1.18	0.33	180
25	33.4	30	0.1	
1½	1.660	1.32	0.46	110
32	42.2	34	0.2	
1½	1.900	1.38	0.57	80
40	48.3	35	0.3	
2	2.375	1.48	0.88	45
50	60.3	38	0.4	
2½	2.875	1.77	1.54	25
65	73.0	45	0.7	

Model 825 Extension Piece

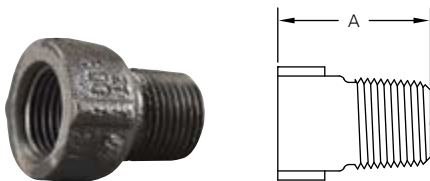

Size	Pipe O.D.	A	Weight	Box Q'ty
in	in	in	Lbs	Pcs
mm	mm	mm	Kgs	
½ x 1½L	0.840 x 1.900	1.50	0.18	300
15 x 40L	21.3 x 48.3	38	0.1	
½ x 2L	1.900 x 2.375	2.00	0.22	250
15 x 50L	21.3 x 60.3	51	0.1	
¾ x 1½L	1.050 x 1.900	1.50	0.22	250
20 x 40L	26.7 x 48.3	38	0.1	
¾ x 2L	1.050 x 2.375	2.00	0.26	200
20 x 50L	26.7 x 60.3	51	0.1	

Model 827 Hex Bushing

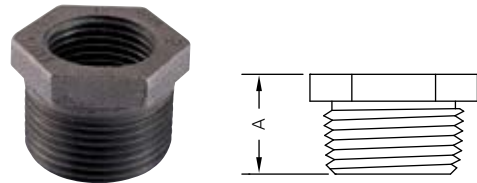

Size	Pipe O.D.	A	Weight	Box Q'ty
in	in	in	Lbs	Pcs
mm	mm	mm	Kgs	
1 x ½	1.315 x 0.840	1.06	0.20	280
25 x 15	33.4 x 21.3	27	0.1	
1 x ¾	1.315 x 1.050	1.06	0.18	280
25 x 20	33.4 x 26.7	27	0.1	
1½ x 1	1.660 x 1.315	1.18	0.29	150
32 x 25	42.2 x 33.4	30	0.1	
1½ x 1	1.900 x 1.315	1.26	0.53	100
40 x 25	48.3 x 21.3	32	0.2	
1½ x 1¼	1.900 x 1.660	1.26	0.37	100
40 x 32	48.3 x 42.2	32	0.2	
2 x 1	2.375 x 1.315	1.34	0.75	80
50 x 25	60.3 x 33.4	34	0.3	
2 x 1¼	2.375 x 1.660	1.34	0.75	80
50 x 32	60.3 x 42.2	34	0.3	
2 x 1½	2.375 x 1.900	1.34	0.64	80
50 x 40	60.3 x 48.3	34	0.3	

Model 831 Long Street 90° Elbow

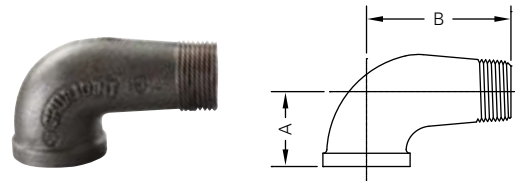

Size	Pipe O.D.	A	B	Weight	Box Q'ty
in	in	in	in	Lbs	Pcs
mm	mm	mm	mm	Kgs	
1 x ½M	1.315 x 0.840	1.50	3.00	0.66	80
25 x 15M	33.4 x 21.3	38	76	0.3	
1 x 1M	1.315 x 1.315	1.50	3.00	0.81	60
25 x 25M	33.4 x 33.4	38	76	0.4	

Model 832 Long Street Tee

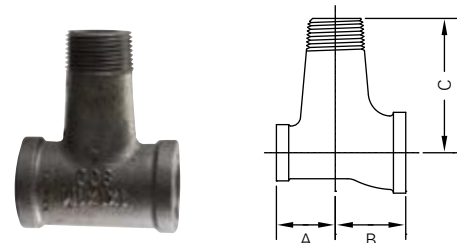

Size	A	B	C	Weight	Box Q'ty
in	in	in	in	Lbs	Pcs
mm	mm	mm	mm	Kgs	
1 x ½ x 1M	1.50	1.40	3.00	0.91	50
25 x 15 x 25M	38	36	76	0.4	
1 x 1 x 1M	1.50	1.50	3.00	1.03	45
25 x 25 x 25M	38	38	76	0.5	

Model 830 Brass Seat Union

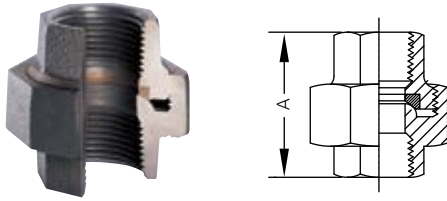

Size	Pipe O.D.	A	Weight	Box Q'ty
in	in	in	Lbs	Pcs
mm	mm	mm	Kgs	
½	0.840	1.81	0.46	110
15	21.3	46	0.2	
¾	1.050	1.99	0.64	80
20	26.7	51	0.3	
1	1.315	2.17	1.01	50
25	33.4	55	0.5	
1¼	1.660	2.52	1.45	35
32	42.2	64	0.7	
1½	1.900	2.64	1.85	25
40	48.3	67	0.8	
2	2.375	3.15	2.86	18
50	60.3	80	1.3	

Model 841 Companion Flange

The Model 841 is a traditional companion flange used for transition from a flanged to a threaded piping system.

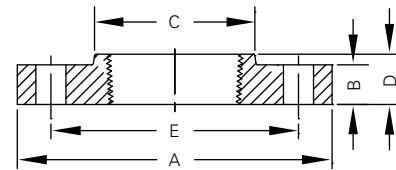

Nominal Pipe Size	Pipe O. D.	Diameter of flange "A"	Thickness of flange "B"	Diameter of hub "C"	Length of hub "D"	Bolt Circle dia. "E"	Bolt No.	Bolt Size	Weight
in	in	in	in	in	in	in		in	Lbs
mm	mm	mm	mm	mm	mm	mm			Kgs
1	1.315	4.25	0.56	1.94	0.69	3.12	4	½ x 2.25	1.54
25	33.4	108	14	49	18	79		—	0.7
1¼	1.660	4.62	0.62	2.31	0.81	3.50	4	½ x 2.50	1.94
32	42.2	117	16	59	21	89		—	0.9
1½	1.900	5.00	0.69	2.56	0.88	3.88	4	½ x 2.50	2.29
40	48.3	127	18	65	22	99		—	1.0
2	2.375	6.00	0.75	3.06	1.00	4.75	4	¾ x 2.75	4.18
50	60.3	152	19	78	25	121		—	1.9
2½	2.875	7.00	0.88	3.56	1.12	5.50	4	¾ x 3.00	5.83
65	73.0	178	22	90	28	140		—	2.6
3	3.500	7.50	0.94	4.25	1.19	6.00	4	¾ x 3.25	6.60
80	88.9	191	24	108	30	152		—	3.0
4	4.500	9.00	0.94	5.31	1.31	7.50	4	¾ x 3.25	11.75
100	114.3	229	24	135	33	191		—	5.3
6	6.625	11.00	1.00	7.56	1.56	9.50	4	¾ x 3.50	16.50
150	168.3	279	25	192	40	241		—	7.5
8	8.625	13.50	1.12	9.69	1.75	11.75	4	¾ x 3.75	25.98
200	219.1	343	28	246	44	298		—	11.8

Model

B20 Standard Top Beam Clamp

B24 Wide Mouth Top Beam Clamp

Size Range: 3/8" and 1/2" rod.

Material: Ductile iron casting with a hardened steel cup-point set screw and lock nut.

Application: Designed for structural attachment to the top of metal beams, channel or other structural shapes to support hanger rod. The universal design allows clamps to be installed in the top or bottom

beam position.

Conforms to: Federal Specification WW-H-171 (Type 23), Manufacturers Standardization Society ANSI/MSS SP-58 (Type 19 & 23), install in accordance with ANSI/MSS SP-69.

Exceeds requirements of NFPA 13.

Finish: Black or electro zinc plated.

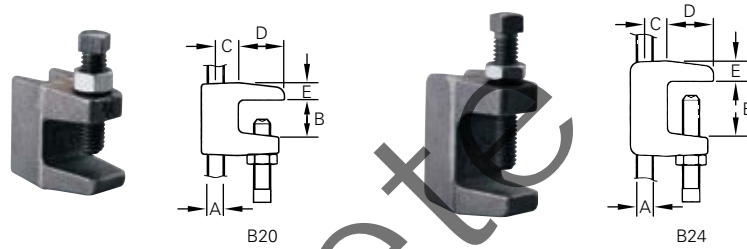

Model No.	Rod Size	Dimensions					Pipe Size	Max. Recom. Load		Weight Per 100 pcs.
		A	B	C	D	E		Top	Bottom	
	in	in	in	in	in	in	Lbs	Lbs	Lbs	
	mm	mm	mm	mm	mm	mm	Kgs	Kgs	Kgs	
B20-3	3/8	3/4	0.49	1	3/8	3/4 - 4	500	250	35.7	
	M10	19.1	12.5	25.4	9.5	20 - 100	227	114	16.2	
B20-4	1/2	3/4	0.49	1	3/8	5, 6, 8	950	750	35.7	
	M12	19.1	12.5	25.4	9.5	125, 150, 200	432	340	16.2	
B24-3	3/8	1 1/8	0.49	1	7/16	3/4 - 4	500	250	43.2	
	M10	28.6	12.5	25.4	11.1	20 - 100	227	114	19.6	
B24-4	1/2	1 1/8	0.49	1	7/16	5, 6, 8	950	750	43.2	
	M12	28.6	12.5	25.4	11.1	125, 150, 200	432	340	19.6	

Model 71 Female Threaded Outlet Fitting

The Shurjoint Model 71 Female Threaded Outlet Fittings are designed to provide a threaded outlet at any desired location along the header. Made of highly weldable SAE J403 forged steel the Model 71 is designed for single pass welding. The Model 71 features a counter bore and a 1.6 mm land around the full circumference of the mouth, which helps ensure full penetration welds and minimize the likelihood of any burn through or distortion that might be caused by excessive heat. The Model 71 is UL / cUL listed and FM approved for services up to 300 psi (20 Bar).

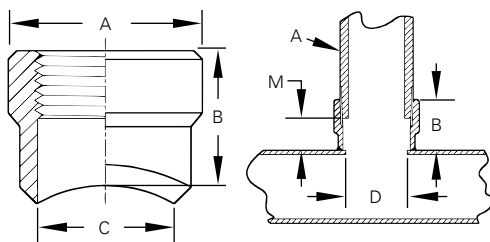
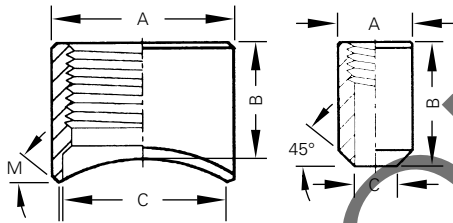
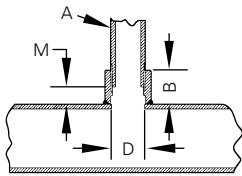

Outlet Size	Header Size Range	Outlet O.D. A	Outlet Length B	Counter-bore C	Make-Up M	Hole Saw Dia. (Ref.) D	Max. Hole Dia. (Ref.) D	Weight	
		in mm	in mm	in mm	in mm	in mm	in mm	Lbs	Kgs
1/4	1 1/4 - 8	0.75	1.25	0.42	0.81	3/8	19/32	0.09	0.04
		19.1	31.8	10.7	20.5	9.5	10.3		
1/2	1 1/2 - 2	1.13	1.00	0.81	0.50	11/16	19/16	0.15	0.07
	2 - 2 1/2	28.6	25.4	20.6	12.7	17.5	20.6	0.15	0.07
	2 1/2 - 8							0.13	0.06
3/4	1 1/4 - 1 1/2							0.11	0.05
	1 1/2 - 2	1.37	1.00	1.06	0.50	7/8	1	0.22	0.10
	2 - 2 1/2	34.9	25.4	26.9	12.7	22.2	25.4	0.20	0.09
1	2 1/2 - 8							0.20	0.09
	1 1/4 - 1 1/2							0.18	0.08
	1 1/2 - 2	1.57	1.13	1.25	0.50	1 1/8	1 1/4	0.24	0.11
15	2 - 2 1/2	40.0	28.6	31.8	12.7	28.6	31.8	0.24	0.11
	2 1/2 - 3							0.24	0.11
	3 - 4							0.24	0.11
3/8	1 1/2 - 2							0.22	0.10
	1 1/2 - 2	1.37	1.00	1.06	0.50	7/8	1	0.20	0.09
	2 - 2 1/2	34.9	25.4	26.9	12.7	22.2	25.4	0.20	0.09
1 1/4	2 1/2 - 8							0.18	0.08
	1 1/4 - 1 1/2							0.24	0.11
	1 1/2 - 2	1.57	1.13	1.25	0.50	1 1/8	1 1/4	0.24	0.11
25	2 - 2 1/2	40.0	28.6	31.8	12.7	28.6	31.8	0.24	0.11
	2 1/2 - 3							0.24	0.11
	3 - 4							0.24	0.11
1/2	1 1/2 - 2							0.22	0.10
	1 1/2 - 2	1.37	1.00	1.06	0.50	7/8	1	0.20	0.09
	2 - 2 1/2	34.9	25.4	26.9	12.7	22.2	25.4	0.20	0.09
32	2 1/2 - 8							0.18	0.08
	1 1/4 - 1 1/2							0.24	0.11
	1 1/2 - 2	1.57	1.13	1.25	0.50	1 1/8	1 1/4	0.24	0.11
1 1/2	2 - 2 1/2	40.0	28.6	31.8	12.7	28.6	31.8	0.24	0.11
	2 1/2 - 3							0.24	0.11
	3 - 4							0.24	0.11
1 1/2	1 1/2 - 2							0.22	0.10
	1 1/2 - 2	1.37	1.00	1.06	0.50	7/8	1	0.20	0.09
	2 - 2 1/2	34.9	25.4	26.9	12.7	22.2	25.4	0.20	0.09
40	2 1/2 - 8							0.18	0.08
	1 1/4 - 1 1/2							0.24	0.11
	1 1/2 - 2	1.57	1.13	1.25	0.50	1 1/8	1 1/4	0.24	0.11
1 1/2	2 - 2 1/2	40.0	28.6	31.8	12.7	28.6	31.8	0.24	0.11
	2 1/2 - 3							0.24	0.11
	3 - 4							0.24	0.11
1 1/2	1 1/2 - 2							0.22	0.10
	1 1/2 - 2	1.37	1.00	1.06	0.50	7/8	1	0.20	0.09
	2 - 2 1/2	34.9	25.4	26.9	12.7	22.2	25.4	0.20	0.09
2	2 1/2 - 8							0.18	0.08
	1 1/4 - 1 1/2							0.24	0.11
	1 1/2 - 2	1.57	1.13	1.25	0.50	1 1/8	1 1/4	0.24	0.11
50	2 - 2 1/2	40.0	28.6	31.8	12.7	28.6	31.8	0.24	0.11
	2 1/2 - 3							0.24	0.11
	3 - 4							0.24	0.11
2	1 1/2 - 2							0.22	0.10
	1 1/2 - 2	1.37	1.00	1.06	0.50	7/8	1	0.20	0.09
	2 - 2 1/2	34.9	25.4	26.9	12.7	22.2	25.4	0.20	0.09
2	2 1/2 - 8							0.18	0.08
	1 1/4 - 1 1/2							0.24	0.11
	1 1/2 - 2	1.57	1.13	1.25	0.50	1 1/8	1 1/4	0.24	0.11
2	2 - 2 1/2	40.0	28.6	31.8	12.7	28.6	31.8	0.24	0.11
	2 1/2 - 3							0.24	0.11
	3 - 4							0.24	0.11
2	1 1/2 - 2							0.22	0.10
	1 1/2 - 2	1.37	1.00	1.06	0.50	7/8	1	0.20	0.09
	2 - 2 1/2	34.9	25.4	26.9	12.7	22.2	25.4	0.20	0.09
2	2 1/2 - 8							0.18	0.08
	1 1/4 - 1 1/2							0.24	0.11
	1 1/2 - 2	1.57	1.13	1.25	0.50	1 1/8	1 1/4	0.24	0.11
2	2 - 2 1/2	40.0	28.6	31.8	12.7	28.6	31.8	0.24	0.11
	2 1/2 - 3							0.24	0.11
	3 - 4							0.24	0.11
2	1 1/2 - 2							0.22	0.10
	1 1/2 - 2	1.37	1.00	1.06	0.50	7/8	1	0.20	0.09
	2 - 2 1/2	34.9	25.4	26.9	12.7	22.2	25.4	0.20	0.09
2	2 1/2 - 8							0.18	0.08
	1 1/4 - 1 1/2							0.24	0.11
	1 1/2 - 2	1.57	1.13	1.25	0.50	1 1/8	1 1/4	0.24	0.11
2	2 - 2 1/2	40.0	28.6	31.8	12.7	28.6	31.8	0.24	0.11
	2 1/2 - 3							0.24	0.11
	3 - 4							0.24	0.11
2	1 1/2 - 2							0.22	0.10
	1 1/2 - 2	1.37	1.00	1.06	0.50	7/8	1	0.20	0.09
	2 - 2 1/2	34.9	25.4	26.9	12.7	22.2	25.4	0.20	0.09
2	2 1/2 - 8							0.18	0.08
	1 1/4 - 1 1/2							0.24	0.11
	1 1/2 - 2	1.57	1.13	1.25	0.50	1 1/8	1 1/4	0.24	0.11
2	2 - 2 1/2	40.0	28.6	31.8	12.7	28.6	31.8	0.24	0.11
	2 1/2 - 3							0.24	0.11
	3 - 4							0.24	0.11
2	1 1/2 - 2							0.22	0.10
	1 1/2 - 2	1.37	1.00	1.06	0.50	7/8	1	0.20	0.09
	2 - 2 1/2	34.9	25.4	26.9	12.7	22.2	25.4	0.20	0.09
2	2 1/2 - 8							0.18	0.08
	1 1/4 - 1 1/2							0.24	0.11
	1 1/2 - 2	1.57	1.13	1.25	0.50	1 1/8	1 1/4	0.24	0.11
2	2 - 2 1/2	40.0	28.6	31.8	12.7	28.6	31.8	0.24	0.11
	2 1/2 - 3							0.24	0.11
	3 - 4							0.24	0.11
2	1 1/2 - 2							0.22	0.10
	1 1/2 - 2	1.37	1.00	1.06	0.50	7/8	1	0.20	0.09
	2 - 2 1/2	34.9	25.4	26.9	12.7	22.2	25.4	0.20	0.09
2	2 1/2 - 8							0.18	0.08
	1 1/4 - 1 1/2							0.24	0.11
	1 1/2 - 2	1.57	1.13	1.25	0.50	1 1/8	1 1/4	0.24	0.11
2	2 - 2 1/2	40.0	28.6	31.8	12.7	28.6	31.8	0.24	0.11
	2 1/2 - 3							0.24	0.11
	3 - 4							0.24	0.11
2	1 1/2 - 2							0.22	0.10
	1 1/2 - 2	1.37	1.00	1.06	0.50	7/8	1	0.20	0.09
	2 - 2 1/2	34.9	25.4	26.9	12.7	22.2	25.4	0.20	0.09
2	2 1/2 - 8							0.18	0.08
	1 1/4 - 1 1/2							0.24	0.11
	1 1/2 - 2	1.57	1.13	1.25	0.50	1 1/8	1 1/4	0.24	0.11
2	2 - 2 1/2	40.0	28.6	31.8	12.7	28.6	31.8	0.24	0.11
	2 1/2 - 3							0.24	0.11
	3 - 4							0.24	0.11
2	1 1/2 - 2							0.22	0.10
	1 1/2 - 2	1.37	1.00	1.06	0.50	7/8	1	0.20	0.09
	2 - 2 1/2	34.9	25.4	26.9	12.7	22.2	25.4	0.20	0.09
2	2 1/2 - 8							0.18	0.08
	1 1/4 - 1 1/2							0.24	0.11
	1 1/2 - 2	1.57	1.13	1.25	0.50	1 1/8	1 1/4	0.24	0.11
2	2 - 2 1/2	40.0	28.6	31.8	12.7	28.6	31.8	0.24	0.11
	2 1/2 - 3							0.24	0.11
	3 - 4							0.24	0.11
2	1 1/2 - 2							0.22	0.10
	1 1/2 - 2	1.37	1.00	1.06	0.50	7/8	1	0.20	0.09
	2 - 2 1/2	34.9	25.4	26.9	12.7	22.2	25.4	0.20	0.09
2	2 1/2 - 8							0.18	0.08
	1 1/4 - 1 1/2							0.24	0.11
	1 1/2 - 2	1.57	1.13	1.25	0.50	1 1/8	1 1/4	0.24	0.11
2	2 - 2 1/2	40.0	28.6	31.8	12.7	28.6	31.8	0.24	0.11
	2 1/2 - 3							0.24	0.11
	3 - 4							0.24	0.11
2	1 1/2 - 2							0.22	0.10
	1 1/2 - 2	1.37	1.00	1.06					

Model 72C Cut Grooved Welding Outlet

Model 72C Cut Grooved Outlet Fittings are designed to provide a cut grooved outlet at any desired location along the header. Made of standard wall (Sch.40) pipe, the Model 72C is recommended for use with Sch. 40 header pipes. The weld end is provided with a 1.6 mm land around the full circumference to assure a one-pass full penetration weld. The 72C fittings are recommended for services up to 300 psi (20 Bar).

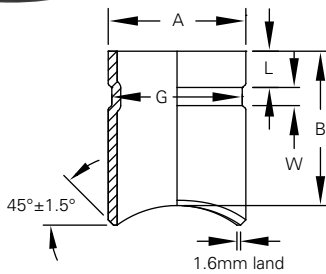

Model 72R Roll Grooved Welding Outlet

Model 72R Roll Grooved Outlet Fittings are designed to provide a roll grooved outlet at any desired location along the header. Made of Sch. 10 pipe, the 72R R-Let is recommended for use with light wall pipes to minimize the likelihood of burn-through and or distortion of the header pipe. The 72R fittings are recommended for services up to 300 psi (20 Bar).

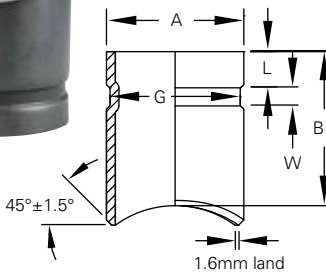

Outlet Size	Run Pipe	Dimensions					Weight
		A	B	L	W	G	
in	in	in	in	in	in	in	Lbs
mm		mm	mm	mm	mm	mm	Kgs
2 50	2	2.375 60.3	3.000 76.2	0.625 15.88	0.312 7.95	2.250 57.15	0.88 0.40
	2½						
	3						
	4						
	5						
2½ 65	6	2.875 73.0	3.000 76.2	0.625 15.88	0.312 7.95	2.722 69.09	1.10 0.50
	8						
	2½						
	4						
	5						
3 80	6	3.500 88.9	3.000 76.2	0.625 15.88	0.312 7.95	3.346 84.94	2.00 0.91
	8						
	4						
	5						
	6						
4 100	8	4.500 114.3	4.000 101.6	0.625 15.88	0.375 9.53	4.337 110.08	3.80 1.73
	6						
	8						
6 150	4	6.625 168.3	4.000 101.6	0.625 15.88	0.375 9.53	6.460 163.96	7.00 3.18
	6						
	8						
8 200	6	8.625 219.1	4.000 101.6	0.750 19.05	0.438 11.13	8.440 214.40	9.50 4.32
	8						

Outlet Size	Run Pipe	Dimensions					Weight
		A	B	L	W	G	
in	in	in	in	in	in	in	Lbs
mm		mm	mm	mm	mm	mm	Kgs
1¼ 32	1¼	1.660 42.2	3.000 76.2	0.625 15.88	0.281 7.14	1.535 38.99	0.33 0.15
	1½						
	2						
	2½						
	3						
1½ 40	4	1.900 48.3	3.000 76.2	0.625 15.88	0.281 7.14	1.775 45.09	0.40 0.18
	5-8						
	1½						
	2						
	2½						
2 50	3	2.375 60.3	3.000 76.2	0.625 15.88	0.344 8.74	2.250 57.15	0.64 0.29
	4						
	5						
	6						
	8						
2½ 65	2½	2.875 73.0	3.000 76.2	0.625 15.88	0.344 8.74	2.720 69.09	1.12 0.51
	3						
	4						
	5						
	6						
76.1 mm	8	3.000 76.1	3.000 76.2	0.625 15.88	0.344 8.74	2.845 72.26	1.12 0.51
	2½						
	3						
	4						
	5						
3 80	6	3.500 88.9	3.000 76.2	0.625 15.88	0.344 8.74	3.440 84.94	1.23 0.56
	8						
	4						
	5						
	6						
4 100	8	4.500 114.3	4.500 114.3	0.625 15.88	0.344 8.74	4.314 110.08	2.07 0.94
	6						
	8						

Section 6

Ring Joint, Shouldered & Plain-End Couplings

Ring Joint, Shouldered & Plain-End Couplings	138
Ring Joint Couplings	
R-88 Ring Joint Coupling	139
R-88 8" ~ 12" Ring Joint Coupling.....	140
R-88N 14" ~ 26" Ring Joint Coupling	141
R-88 28" ~ 96" Large Diameter Ring Joint Coupling.....	142
RH-1000 1000 psi Ring Joint Coupling.....	144
RX-3000 3000 psi Ring Joint Coupling	144
RX-3770 3770 psi Ring Joint Coupling	145
Ring Joint Fittings	
RJ-10 / RJ-11 / RJ-20 / RJ-60 Elbows, Tee & Cap	146
RJ-21 / RJ-50 / RJ-51 / RJ-70 Reducing Tee, Concentric Reducer, Eccentric Reducer & Flange Adapter.....	147
Pressure Performance Data	148
Shouldered Couplings	
S35 Shouldered Flexible Coupling.....	150
SD-28A Shouldered Toggle Coupling	150
Plain-End Coupling	
79 Wildcat Coupling	151

Ring Joint, Shouldered and Plain End Couplings

Shurjoint ring joint, shouldered and plain end couplings are non-grooved mechanical pipe joining components and excellent alternatives where pipe is difficult to groove or when grooving is not the preferred method. The processing of a roll groove

on pipe becomes more difficult as the pipe O.D. and or wall thickness increases. Roll grooving pipe larger than 14" (350 mm) requires proper tools and equipment. Pipe having a wall thickness greater than 0.375" (9.5 mm) may not be practical to roll groove.

Ring Joint Coupling The Shurjoint ring joint coupling provides a much more secure joint than a comparable roll-grooved system, simply because the contact area of the rings is much greater than that of the roll-groove profile. In addition, the welded rings are able to withstand 2 - 3 times the shearing forces of roll grooves. High pressure couplings up to 3770 psi (260 Bar) are available.

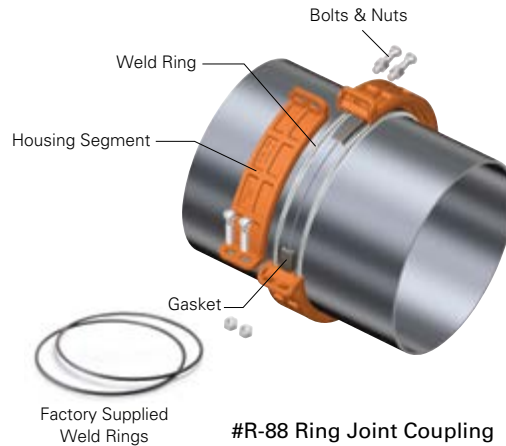

Shouldered Coupling The Shurjoint shouldered piping system is a classic and versatile pipe joining method which utilizes Type A weld-on rings. Shurjoint shouldered couplings are widely used in irrigation, dewatering on construction sites, and other installations.

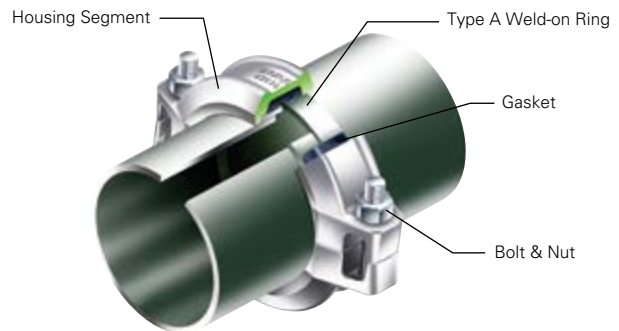

Plain-End Coupling The Shurjoint plain-end coupling securely grips the pipe with its built-in case hardened jaws incorporated within heavy duty housing segments and heavy duty bolts and nuts. The Shurjoint Model 79 Wildcat coupling is designed to join plain-end or beveled-end carbon steel pipe without roll-grooving, welding or threading. The Model 79 plain-end coupling can be used for mining, process piping, manifold piping, and oil field services.

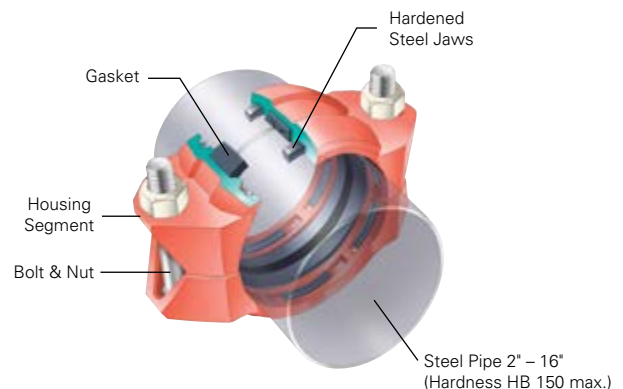

Model R-88 Ring Joint Coupling

The Shurjoint Model R-88 Ring Joint Coupling is supplied with a pair of factory supplied weld rings. For installation weld a factory-supplied weld ring on each pipe end to be connected, next mount the rubber gasket over the pipe ends, place coupling segments over the gasket and fasten the bolts and nuts.

The Shurjoint R-88 Ring Joint Coupling is considered a shoulder coupling with the factory supplied weld rings serving as the joint shoulders. The R-88's performance standards meet and or exceed the requirements of ASTM F1476 and AWWA C606. The factory supplied weld rings offer a much more economical and convenient alternative to traditional shoulder rings, such as Type A, B, C, D, E, and G rings.

The R-88 Coupling can also be used on stainless steel pipe with optional weld rings available in compatible stainless steel grades. Check with Shurjoint for details and availability.

Typical applications

- Water & Waste Water Treatment Plants
- Mining & Tunnel Boring
- Pulp & Paper
- Hydroelectric Plants
- Co-Gen Electric Plants
- Food & Beverage
- Compressed Air
- HVAC



Max. Internal Service Pressures of Carbon Steel Pipe ASTM A53 Gr. B

When designing a piping system you must select pipe with the appropriate wall thickness to correspond with the intended working pressure of the system. The table lists design working pressure by the pipe wall schedule, XS, STD and LW, of representative ASTM A53 Gr. B carbon steel pipe calculated in accordance with the formula stipulated in ASME B31.1 Power Piping 104.1.

$$P = \frac{2SE (tm-A)}{Do - 2y (tm - A)}$$

Where:

- P = Maximum internal service pressure (psi)
- SE = Allowable stress (psi)
(ASTM A53 Gr. B = 15,000 psi)
- tm = Minimum pipe wall thickness (inch)
(87.5% of nominal wall thickness)
- Do = Outside diameter of pipe (inch)
- y = A coefficient (For ferritic steels 600°F or below = 0.4)
- A = Additional thickness (inch) (A = 0)

Max. Internal Service Pressure of Carbon Steel Pipe, ASTM A53 Gr. B

Unit: psi

Nom. Size in / mm	XS 0.5"	STD 0.375**	LW 0.25" / 0.312" ^
8 / 200	1586	1006	777
10 / 250	1262	913	621
12 / 300	1058	788	522
14 / 350	962	717	475
16 / 400	839	625	415
18 / 450	744	555	368
20 / 500	668	499	331
24 / 600	555	415	275
26 / 650	512	382	318
28 / 700	475	355	295
30 / 750	443	331	275
32 / 800	415	310	258
36 / 900	368	275	229
38 / 950	349	261	217
40 / 1000	331	248	206
42 / 1050	315	236	187
44 / 1100	301	225	
48 / 1200	275	206	
52 / 1300	254	190	
54 / 1350	245	183	
56 / 1400	236	177	
60 / 1500	220	165	
66 / 1650	200	150	
68 / 1700	194	145	
72 / 1800	183	137	
84 / 2100	157	118	
96 / 2400	137	103	

Except *8": 0.322", ^ 8" ~ 24": 0.25", 26" ~ 42": 0.312"

Model R-88 Ring Joint Coupling

The Shurjoint Model R-88 Ring Joint Coupling is an ideal pipe joining method when pipe is difficult to groove or when grooving is not the preferred joining method. Available in sizes 8" to 96" the R-88 offers ease of use and excellent performance.



R-88
Size: 12"

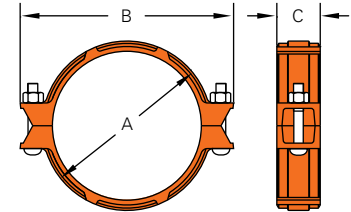
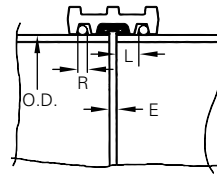
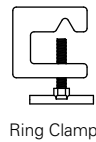

8" ~ 12"

Nominal Size	Pipe O.D.	Rings both sides fully welded*		Axial Displacement † E	Angular Movement / Deflection †	Dimensions				Bolts		Sealing Surface L	Ring Size R	No. of Clamps‡	Weight
		Max. Working Pressure (CWP)#	Max. End Load (CWP)#			Per Cplg	Per Pipe	A	B	C	No.				
		PSI	Lbs									in	in / ft	in	in
8	8.625	400	23350	0-0.340	2.14	0.45	10.08	13.00	3.11	2	¾ x 4¾	0.91	¼	3	16.8
200	219.1	28	105.51	0-8.7		37	256	330	79		M20x120	23	6.0		7.6
10	10.750	400	36280	0-0.340	1.95	0.41	12.29	15.20	3.25	2	¾ x 4¾	0.91	¼	3	22.2
250	273.0	28	163.81	0-8.7		34	312	386	83		M20 x 120	23	6.0		10.1
12	12.750	400	51040	0-0.190	0.82	0.17	14.72	17.90	3.39	2	7/8 x 6½	1.02	5/16	3	30.8
300	323.9	28	230.59	0-4.8		14	374	455	86		—	26	8.0		14.0
200 JIS	8.516	400	22770	0-0.340	1.50	0.31	9.96	12.87	3.11	2	—	0.91	¼	3	17.6
	216.3	28	102.83	0-8.7		26	253	327	79		M20 x 120	23	6.0		8.0
250 JIS	10.528	400	34800	0-0.340	1.50	0.31	12.05	14.96	3.25	2	—	0.91	¼	3	22.0
	267.4	28	157.16	0-8.7		26	306	380	83		M20 x 120	23	6.0		10.0
300 JIS	12.539	400	49360	0-0.190	1.50	0.31	14.53	17.72	3.39	2	—	1.02	5/16	3	32.6
	318.5	28	222.97	0-4.8		26	369	450	86		M20 x 120	26	8.0		14.8

1) Dimensions are subject to change without notice. Other sizes are available on request.

* Working Pressure is based on rings both sides fully welded standard wall carbon steel pipe.

Working Pressure and End Load are the total from all internal and external loads based on the applicable pipe wall thickness.

† Allowable Axial Displacement and Angular Movement (Deflection) figures shown are the maximum nominal range of movement at each R-88 coupling joint when rings are welded in the standard position. For design and installation purposes these figures should be reduced by 25%.

‡ The number of ring clamps listed is the minimum required to correctly position the weld ring around the circumference of the pipe end.

Model R-88N Ring Joint Coupling

The Shurjoint Model R-88N is a two segment Ring Joint Coupling. Available in sizes 14" to 26" (350 mm to 650 mm). The two-segment style offers an easier and faster installation.



R-88N
Size: 24"

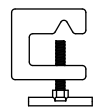

Ring Clamp

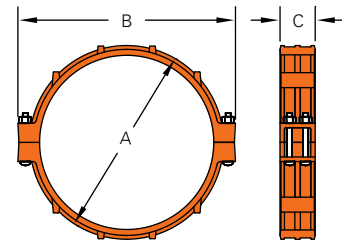
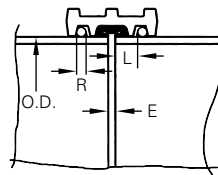

14" ~ 26"

Nominal Size	Pipe O.D.	Rings both sides fully welded*		Axial Displacement † E	Angular Movement / Deflection †	Dimensions				Bolts		Sealing Surface L	Ring Size R	No. of Clamps ‡	Weight	
		Max. Working Pressure (CWP)#	Max. End Load (CWP)#			Per Cplg	Per Pipe	A	B	C	No.					Size
14	14.000	400	61540	0-0.250	1.20	0.25	15.93	19.40	3.65	2	7/8 x 5 1/2	1.02	5/16	4	38.3	
350	355.6	28	277.94	0-6.4		21	405	493	93		—	26	8.0		17.4	
16	16.000	400	80380	0-0.250	0.90	0.19	17.92	21.52	3.65	2	7/8 x 5 1/2	1.02	5/16	4	35.0	
400	406.4	28	363.02	0-6.4		16	455	547	93		—	26	8.0		15.9	
18	18.000	400	101730	0-0.375	1.20	0.25	20.37	24.17	4.23	2	1 x 5 1/2	1.18	5/16	4	50.6	
450	457.2	28	459.45	0-9.5		21	517	614	107		—	30	8.0 †		23.0	
20	20.000	400	125600	0-0.375	1.08	0.23	22.46	25.99	4.35	2	1 x 5 1/2	1.18	3/8	4	68.7	
500	508.0	28	567.22	0-9.5		19	570	660	110		—	30	9.5		31.2	
24	24.000	400	180860	0-0.375	0.80	0.17	27.17	30.00	4.84	4	7/8 x 6 1/2	1.18	1/2	4	104.7	
600	609.6	28	816.80	0-9.5		14	690	762	123		—	30	12.7		47.5	
26	26.000	300	159190	0-0.500	1.06	0.22	29.58	32.78	6.69	4	1 x 10	1.97	1/2	4	173.5	
650	660.4	20	684.72	0-12.7		18	751	832	170		—	50	12.7		78.7	

1) Dimensions are subject to change without notice. Other sizes are available on request.

* Working Pressure is based on rings both sides fully welded standard wall carbon steel pipe.

Working Pressure and End Load are the total from all internal and external loads based on the applicable pipe wall thickness.

† Allowable Axial Displacement and Angular Movement (Deflection) figures shown are the maximum nominal range of movement at each R-88 coupling joint when rings are welded in the standard position. For design and installation purposes these figures should be reduced by 25%.

‡ The number of ring clamps listed is the minimum required to correctly position the weld ring around the circumference of the pipe end.

Model

R-88 Ring Joint Coupling

Large diameter

The Shurjoint Model R-88 Ring Joint Coupling is available in sizes 28" to 96" (700 mm to 2400 mm). The larger diameter couplings are comprised of 4 to 8 housing segments depending on the size and feature two bolts at each joint segment to ensure a positive connection.

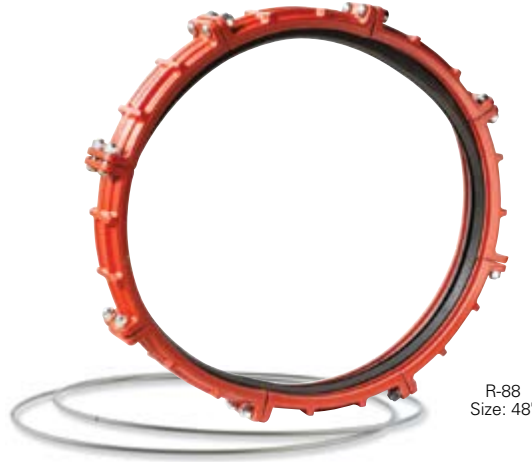

R-88
Size: 48"

Nominal Size	Pipe O.D.	Rings both sides fully welded*		Axial Displacement † E	Angular Movement / Deflection †	Dimensions			Bolts	Sealing Surface	Ring Size	No. of Clamps†	Weight		
		Max. Working Pressure (CWP)#	Max. End Load (CWP)#			Per Cplg	Per Pipe	A						B	C
		PSI	Lbs												
in	in	Bar	kN	mm	Deg.(°)	mm / m	mm	mm	mm	No.	Size	L	R	Lbs	
mm	mm	Bar	kN	mm	Deg.(°)	mm / m	mm	mm	mm		in	in	in	Kgs	
28	28.0	300	184630	0-0.500	0.90	0.19	31.75	35.47	6.69	12	7/8 x 4	2.00	1/2	222.2	
700	711.2	20	794.11	0-12.7		16	806	901	170			50	12.7	101.0	
30	30.0	300	211950	0-0.500	0.86	0.18	33.75	37.60	6.69	12	1 x 3 1/2	2.00	1/2	218.9	
750	762.0	20	911.61	0-12.7		15	857	955	170			50	12.7	99.5	
32	32.0	300	241150	0-0.500	0.84	0.18	35.75	39.45	6.69	12	1 x 3 1/2	2.00	1/2	225.4	
800	812.8	20	1037.21	0-12.7		15	908	1002	170			50	12.7	102.2	
34**	34.0	300	272230	0-0.500	0.84	0.18	37.75	41.50	7.87	12	1 x 3 1/2	2.00	1/2	253.0	
850	863.4	20	1170.37	0-12.7		15	959	1054	200			50	12.7	115.0	
36	36.0	300	305200	0-0.500	0.76	0.16	39.75	43.50	7.87	12	1 x 3 1/2	2.00	1/2	246.0	
900	914.4	20	1312.72	0-12.7		13	1010	1103	200			50	12.7	111.6	
38**	38.0	232	262980	0-0.500	0.76	0.16	41.75	45.50	7.87	12	1 x 3 1/2	2.00	1/2	275.0	
950	965.2	16	1170.10	0-12.7		13	1060	1156	200			50	12.7	125.0	
40	40.0	232	291390	0-0.625	0.80	0.17	44.69	48.39	7.87	16	1 x 3 1/2	2.37	5/8	310.2	
1000	1016.0	16	1296.51	0-15.9		14	1135	1229	200			60	15.9	141.0	
42	42.0	232	321250	0-0.625	0.86	0.18	46.70	50.71	7.87	16	1 1/4 x 5	2.37	5/8	326.9	
1050	1066.8	16	1429.41	0-15.9		15	1186	1288	200			60	15.9	148.6	
44**	44.0	232	352580	0-0.625	0.80	0.17	48.66	52.64	7.87	16	1 1/4 x 5	2.37	5/8	343.2	
1100	1117.6	16	1568.78	0-15.9		14	1236	1337	200			60	15.9	156.0	
48	48.0	232	419600	0-0.625	0.70	0.15	52.68	55.91	7.87	16	1 x 3 1/2	2.37	5/8	466.7	
1200	1219.2	16	1866.98	0-15.9		12	1338	1420	200			60	15.9	211.8	

Continued on next page.

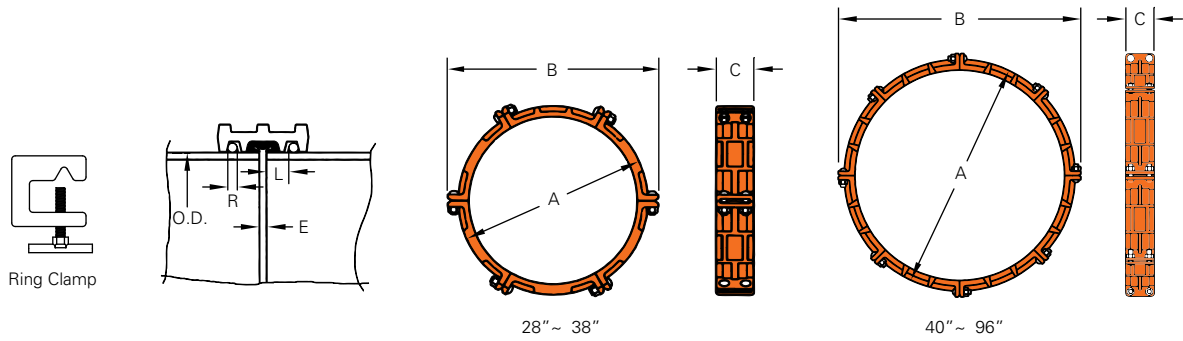

Continued from previous page.

Nominal Size	Pipe O.D.	Rings both sides fully welded*		Axial Displacement † E	Angular Movement / Deflection †	Dimensions			Bolts		Sealing Surface L	Ring Size R	No. of Clamps ‡	Weight		
		Max. Working Pressure (CWP)# PSI	Max. End Load (CWP)# Lbs			Per Cplg	Per Pipe	A	B	C					No.	Size
in	in	Bar	kN	in	Deg.(°)	in / ft	in	in	in		in	in		Lbs		
mm	mm			mm		mm / m	mm	mm	mm		mm	mm		Kgs		
52**	52.0	175	371460	0-0.625	---	---	61.25	60.67	7.87	16	1 ¼ x 5	2.37	¾	453.2		
1300	1320.8	12	1643.33	0-15.9	---	---	1555	1541	200			60	15.9	206.0		
54**	54.0	175	400580	0-0.625	---	---	63.25	62.52	7.87	16	1 ¼ x 5	2.37	¾	472.1		
1350	1371.6	12	1772.17	0-15.9	---	---	1607	1588	200			60	15.9	214.6		
56**	56.0	175	430800	0-0.625	---	---	65.38	64.69	7.87	16	1 ¼ x 5	2.37	¾	488.2		
1400	1422.4	12	1905.87	0-15.9	---	---	1660	1643	200			60	15.9	222.0		
60**	60.0	175	494550	0-0.625	---	---	69.38	68.82	7.87	16	1 ¼ x 5	2.37	¾	537.2		
1500	1524.0	12	2187.87	0-15.9	---	---	1762	1748	200			60	15.9	244.2		
66**	66.0	175	598709	0-0.750	---	---	76.00	75.75	8.00	16	1 ½ x 5	2.37	¾	612.5		
1650	1676.4	12	2663.19	0-19.1	---	---	1932	1924	216			60	19.1	278.4		
68	68.0	175	635544	0-0.750	---	---	78.50	78.03	8.00	16	1 ½ x 5	2.37	¾	785.4		
1700	1727.2	12	2827.04	0-19.1	---	---	1994	1982	216			60	19.1	357.0		
72	72.0	175	712513	0-0.750	---	---	82.50	82.28	8.00	16	1 ½ x 6 ¾	2.37	¾	737.7		
1800	1828.8	12	3169.41	0-19.1	---	---	2095	2090	216			60	19.1	335.3		
84**	84.0	100	553890	0-0.750	---	---	94.75	93.81	8.00	16	1 ½ x 5	2.37	¾	780.3		
2100	2133.6	7	2501.46	0-19.1	---	---	2406	2383	216			60	19.1	354.7		
96**	96.0	100	723450	0-0.750	---	---	106.75	106.54	8.00	16	1 ½ x 5	2.37	¾	823.2		
2400	2438.4	7	3267.21	0-19.1	---	---	2711	2706	216			60	19.1	374.2		

Dimensions are subject to change without notice. Other sizes are available on request.

* Working Pressure is based on rings both sides fully welded standard wall carbon steel pipe.

Working Pressure and End Load are the total from all internal and external loads based on the applicable pipe wall thickness.

† Allowable Axial Displacement and Angular Movement (Deflection) figures shown are the maximum nominal range of movement at each R-88 coupling joint when rings are welded in the standard position. For design and installation purposes these figures should be reduced by 25%.

‡ The number of ring clamps listed is the minimum required to correctly position the weld ring around the circumference of the pipe end.

** Non-standard/stock items may require longer lead time.

Model RH-1000 1000 PSI Ring Joint Coupling

The Shurjoint Model RH-1000 coupling is a high pressure ring joint coupling for use with Sch. 40, Sch. 80 and heavier wall carbon steel pipe.

The coupling is comprised of two ductile

iron heavy-wall housings, rubber gasket (EPDM or Nitrile) and two heat-treated track bolts and nuts which provide a fully restrained joint and a maximum working pressure of 1,000 psi (70 Bar) depending on

the pipe used.

Two steel weld rings are factory supplied with the coupling. Steel rings must always be fully welded on both sides.

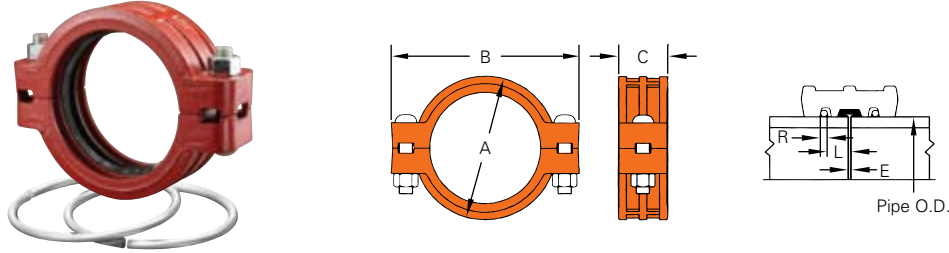

Nominal Size	Pipe O.D.	Max. Working Pressure (CWP)*	Max. End Load (CWP)	Dimensions			Bolt / Nut †		Deflection	Pipe-end Preparation			Weight
				A	B	C	No.	Size		R	L	E (max)	
in	in	PSI	Lbs	in	in	in		in	Deg.	in	in	in	Lbs
mm	mm	Bar	kN	mm	mm	mm		in		mm	mm	mm	Kgs
8	8.625	1000	58390	11.10	14.65	3.86	2	1 x 5½	0° - 18'	0.472 - 0.500	1	0.13	39.8
200	219.1	69	263.79	282	372	98				12.0 - 12.7	25	3.2	18.1
10**	10.750	1000	90710	13.32	16.93	4.25	2	1 x 6½	0° - 38'	0.472 - 0.500	1	0.13	57.2
250	273	69	409.54	340	430	108				12.0 - 12.7	25	3.2	26.0
12**	12.750	1000	127610	16.33	20.07	4.17	2	1 x 6½	0° - 32'	0.472 - 0.500	1	0.13	72.6
300	323.9	69	576.49	415	510	106				12.0 - 12.7	25	3.2	33.0

* Working pressure is based on standard wall carbon steel pipe. Burst test pressures are minimum 2 times the maximum working pressures.

† Bolt & nut are UNC threaded. **Non-standard/stock items may require longer lead time.

Model RX-3000 3000 PSI Ring Joint Coupling

The Shurjoint Model RX-3000 coupling is a high pressure ring joint coupling for use with Sch. 80, 120 and heavier wall carbon steel pipe.

The coupling is comprised of two ductile

iron heavy-wall housings, rubber gasket (EPDM or Nitrile) and four heat-treated track bolts and nuts which provide a fully restrained joint and a maximum working pressure up to 3,000 psi (210 Bar)

depending on the pipe used.

Two steel weld rings are factory supplied with the coupling. Steel rings must always be fully welded on both sides.

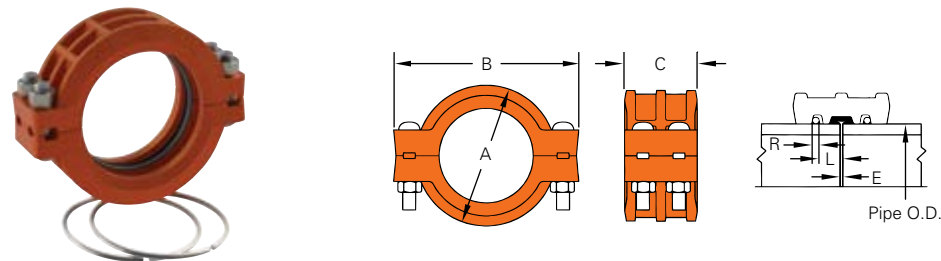

Nominal Size	Pipe O.D.	Max. Working Pressure (CWP)*	Max. End Load (CWP)	Dimensions			Bolt / Nut †		Pipe-end Preparation	Weight		
				A	B	C	No.	Size			R	L
in	in	PSI	Lbs	in	in	in		in	in	in	Lbs	
mm	mm	Bar	kN	mm	mm	mm		in		mm	mm	Kgs
8	8.625	3000	175180	11.81	15.51	5.83	2	1½ x 5½	0.472 ~ 0.500	1.22	½	78.92
200	219.1	207	791.36	300	394	148			12.0 ~ 12.7	31	3	35.87
10	10.748	3000	272040	14.96	18.93	5.98	4	1¼ x 6½	0.625 ~ 0.629	1.22	½	116.36
250	273.0	207	1228.61	380	481	152			15.9 ~ 16.0	31	3	52.78
12**	12.752	3000	382950	18.50	22.48	6.81	4	1½ x 6¼	0.625 ~ 0.629	1.22	½	212.27
300	323.9	207	1729.46	470	572	173			15.9 ~ 16.0	31	3	96.24

* Working pressure is based on API 5L X65 line pipe. Burst test pressures are minimum 2 times the maximum working pressures.

† Bolt & nut are UNC threaded. **Non-standard/stock items may require longer lead time.

Model RX-3770 3770 PSI Ring Joint Coupling

The Shurjoint Model RX-3770 Ring Joint Coupling is designed to provide a fully restrained joint for use with extra-strong carbon steel pipe including API 5L Grade

X65 line pipe.

The coupling is comprised of two ductile iron heavy-wall housing segments, rubber gasket (EPDM) and four heat-treated track

bolts and nuts. Two steel weld rings are factory supplied with a coupling. Steel rings shall always be fully welded on both sides.

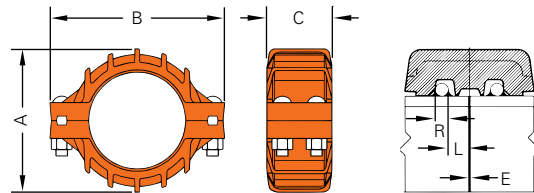

Nominal Size	Pipe O.D.	Max. Working Pressure (CWP)*	Max. End Load (CWP)	Dimensions			Bolt / Nut †		Pipe-end Preparation			Weight
				A	B	C	No.	Size	R	L	E (max)	
in	in	PSI	Lbs	in	in	in			in	in	in	Lbs
mm	mm	Bar	kN	mm	mm	mm		in	mm	mm	mm	Kgs
6	6.625	3770	129890	10.24	12.64	5.87	4	7/8 x 6 1/2	0.472	1.22	0.20	61.2
150	168.3	260	578.11	260	321	149			12	31	5	27.7
8	8.625	3770	220150	12.95	16.30	6.89	4	1 1/4 x 6 1/2	0.625	1.50	0.20	110.0
200	219.1	260	979.78	329	414	175			16	38	5	49.9
10	10.750	3770	342000	15.90	19.84	7.72	4	1 1/2 x 6 7/8	0.750	1.50	0.20	174.5
250	273.0	260	1521.14	404	504	196			19	38	5	79.2
12	12.750	3770	481090	19.00	23.10	8.63	4	1 1/2 x 6 7/8	0.875	1.50	0.24	247.1
300	323.9	260	2141.24	482	587	219			22	38	6	112.3

* Working pressure is based on API 5L X65 line pipe. Burst test pressures are minimum 2 times the maximum working pressures.

† Bolt & nut are UNC threaded.

Ring Joint Fittings

Model

RJ-10 90° Elbow
RJ-20 Tee

RJ-11 45° Elbow
RJ-60 Cap

Shurjoint offers a full range of ring joint fittings for use with Model R-88 ring joint couplings.

- RJ Series fittings are made of carbon steel standard weight pipe, ASTM A53

Gr. B, or fabricated from wrought carbon steel of equivalent properties.

- Other configurations are also available upon request. Contact Shurjoint for details.

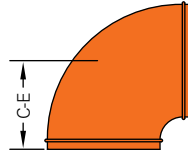

RJ-10

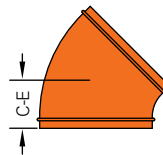

RJ-11

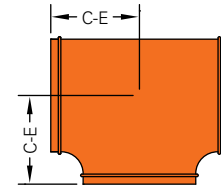

RJ-20

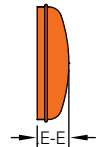

RJ-60

Nominal Size	Pipe O.D.	RJ-10 90° Elbow		RJ-11 45° Elbow		RJ-20 Tee		RJ-60 Cap	
		C - E	Weight	C - E	Weight	C - E	Weight	E - E	Weight
in	in	in	Lbs	in	Lbs	in	Lbs	in	Lbs
mm	mm	mm	Kgs	mm	Kgs	mm	Kgs	mm	Kgs
8	8.625	12.00	28.6	5.00	20.9	7.00	46.2	3.00	12.1
200	219.1	305	13.0	127	9.5	178	21.0	76	5.5
10	10.750	15.00	55.0	6.25	39.6	9.00	72.6	3.00	13.2
250	273.0	381	25.0	159	18.0	229	33.0	76	6.0
12	12.750	18.00	77.0	7.50	50.6	10.00	103.4	3.00	17.6
300	323.9	457	35.0	190	23.0	254	47.0	76	8.0
200 JIS	8.516	12.00	28.6	5.00	20.9	7.00	46.2	3.00	12.1
	216.3	305	13.0	127	9.5	178	21.0	76	5.5
250 JIS	10.528	15.00	55.0	6.25	39.6	9.00	72.6	3.00	13.2
	267.4	381	25.0	159	18.0	229	33.0	76	6.0
300 JIS	12.539	18.00	77.0	7.50	50.6	10.00	103.4	3.00	17.6
	318.5	457	35.0	190	23.0	254	47.0	76	8.0
14	14.000	21.00	81.4	6.00	52.8	11.00	118.8	4.00	26.4
350	355.6	533	37.0	152	24.0	280	54.0	102	12.0
16	16.000	24.00	99.0	7.25	101.2	12.00	154.0	4.00	33.0
400	406.4	610	45.0	184	46.0	305	70.0	102	15.0
18	18.000	27.00	209.0	11.25	105.6	13.50	268.0	5.00	46.2
450	457.2	686	95.0	286	48.0	343	122.0	127	21.0
20	20.000	30.00	203.6	12.50	110.0	17.25	337.0	6.00	57.2
500	508.0	762	138.0	318	50.0	438	153.0	152	26.0
24	24.000	36.00	485.0	15.00	176.0	17.00	466.0	6.00	77.0
600	609.6	914	220.0	381	80.0	432	212.0	152	35.0
26	26.000	39.00	521.0	16.00	262.0	22.50	766.0	10.50	110.0
650	660.4	991	237.0	406	119.0	572	348.0	267	50.0
28	28.000	42.00	605.0	17.25	304.0	23.50	862.0	10.50	123.0
700	711.2	1067	275.0	438	138.0	597	392.0	267	56.0
30	30.000	45.00	695.0	18.50	348.0	25.00	992.0	10.50	136.0
750	76.20	1143	316.0	480	158.0	635	451.0	267	62.0
32	32.000	48.00	792.0	19.75	396.0	26.50	1135.0	10.50	248.6
800	812.8	1219	360.0	502	180.0	673	516.0	267	113.0
34	34.000	51.00	895.0	21.00	449.0	28.00	1285.0	10.50	165.0
850	863.4	1295	407.0	533	204.0	711	584.0	267	75.0
36	36.000	54.00	1005.0	22.25	504.0	30.00	1445.0	10.50	334.4
900	914.4	1372	457.0	565	229.0	762	657.0	267	152.0
40	40.000	60.00	1241.0	24.88	620.0	33.00	1790.0	12.00	224.0
1000	1016.0	1524	564.0	632	282.0	838	814.0	305	102.0
42	42.000	63.00	1368.0	26.00	684.0	35.00	1841.0	12.00	242.0
1050	1066.8	1600	622.0	660	311.0	889	837.0	305	110.0
44	44.000	66.00	1503.0	27.39	752.0	36.00	2075.0	13.50	277.0
1100	1117.6	1676	683.0	696	342.0	914	943.0	343	126.0
48	48.000	72.00	1790.0	29.88	895.0	40.00	2488.0	13.50	315.0
1200	1219.2	1829	814.0	759	407.0	1016	1131.0	343	143.0

• C-E of RJ-10 and RJ-11 18" and larger sizes and E-E of RJ-60 26" and larger sizes conform to ANSI B16.9. All other sizes are to manufacturer's standard.

Ring Joint Fittings

Model

RJ-21 Reducing Tee RJ-50 Concentric Reducer RJ-51 Eccentric Reducer

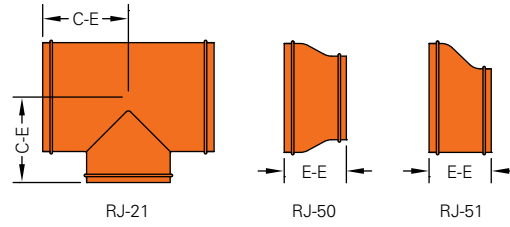

Nominal Size	Pipe O.D.	RJ-21 Reducing Tee			RJ-50 Conc. Reducer		RJ-51 Ecc. Reducer	
		C - E	C - B	Weight	E - E	Weight	E - E	Weight
in	in	in	in	Lbs	in	Lbs	in	Lbs
mm	mm	mm	mm	Kgs	mm	Kgs	mm	Kgs
14 x 12	14.000 x 12.750	11.00	10.62	145.0	8.00	51.0	13.00	51.0
350 x 300	355.6 x 323.9	279	270	66.0	203*	23.0	330	23.0
16 x 12	16.000 x 12.750	12.00	11.62	172.0	9.00*	64.0	9.00*	64.0
400 x 300	406.4 x 323.9	305	295	78.0	229	29.0	229	29.0
16 x 14	16.000 x 14.000	12.00	12.00	176.0	9.00*	64.0	9.00*	64.0
400 x 350	406.4 x 355.6	305	305	80.0	229	29.0	229	29.0
18 x 12	18.000 x 12.750	13.50	12.62	246.0	9.50*	72.6	15.00	78.0
450 x 300	457.2 x 323.9	343	321	112.0	241	33.0	381	35.0
18 x 14	18.000 x 14.000	13.50	13.00	253.0	15.00	79.0	15.00	79.0
450 x 350	457.2 x 355.6	343	330	115.0	381	36.0	381	36.0
18 x 16	18.000 x 16.000	13.50	13.00	264.0	15.00	79.0	15.00	79.0
450 x 400	457.2 x 406.4	343	330	120.0	381	36.0	381	36.0
20 x 12	20.000 x 12.750	15.00	13.62	297.0	10.00*	95.0	20.00	95.0
500 x 300	508.0 x 323.9	381	346	135.0	254	43.0	508	43.0
20 x 14	20.000 x 14.000	15.00	14.00	304.0	20.00	99.0	20.00	99.0
500 x 350	508.0 x 355.6	381	356	138.0	508	45.0	508	45.0
20 x 16	20.000 x 16.000	15.00	14.00	317.0	20.00	101.0	20.00	101.0
500 x 400	508.0 x 406.4	381	356	144.0	508	46.0	508	46.0
20 x 18	20.000 x 18.000	15.00	14.50	328.0	20.00	128.0	20.00	128.0
500 x 450	508.0 x 457.2	381	368	149.0	508	58.0	508	58.0
24 x 12	24.000 x 12.750	17.00	15.62	396.0	12.00*	154.0	20.00	154.0
600 x 300	609.6 x 323.9	432	397	180.0	305	70.0	508	70.0
24 x 14	24.000 x 14.000	17.00	16.00	407.0	20.00	154.0	20.00	154.0
600 x 350	609.6 x 355.6	432	406	185.0	508	70.0	508	70.0
24 x 16	24.000 x 16.000	17.00	16.00	418.0	12.00*	154.0	20.00	154.0
600 x 400	609.6 x 406.4	432	406	190.0	305	70.0	508	70.0
24 x 18	24.000 x 18.000	17.00	16.50	433.0	20.00	154.0	20.00	154.0
600 x 450	609.6 x 457.2	432	419	197.0	508	70.0	508	70.0
24 x 20	24.000 x 20.000	17.00	17.00	444.0	20.00*	156.0	20.00	156.0
600 x 500	609.6 x 508.0	432	432	202.0	508	71.0	508	71.0

C-E: Mfr's standard. E-E marked (*): Mfr's standard (made of ductile iron). All other E-E: ANSI B16.9.

Model

RJ-70 Flange Adapter ANSI Class 125/150

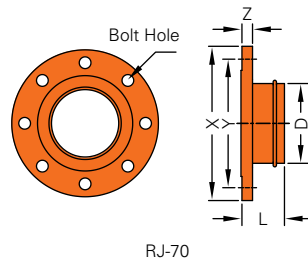

RJ-70

Nominal Size	Pipe O.D. D	RJ-70 Flange Adapter							
		X	Y	Z	Bolt Size	Bolt Hole		L	Weight
in	in	in	in	in	in	in	No.	in	Lbs
mm	mm	mm	mm	mm		in		mm	Kgs
8	8.625	13.500	11.750	1.125	3/4	7/8	8	6	44.9
200	219.1	343.0	298.0	29.0	3/4	7/8	8	152	20.4
10	10.750	16.000	14.250	1.180	7/8	1	12	8	67.1
250	273.0	406.4	362.0	30.0	7/8	1	12	203	30.5
12	12.750	19.000	17.000	1.250	7/8	1	12	8	98.1
300	323.9	483.0	432.0	32.0	7/8	1	12	203	44.6
14	14.000	21.000	18.750	1.377	1	1 1/8	12	8	118.8
350	355.6	533.0	476.25	35.0	1	1 1/8	12	203	54.0
16	16.000	23.500	21.250	1.456	1	1 1/8	16	8	147.0
400	406.4	597.0	539.75	37.0	1	1 1/8	16	203	66.8
18	18.000	25.000	22.751	1.059	1 1/8	1 1/4	16	8	143.0
450	457.2	635.0	577.9	26.9	1 1/8	1 1/4	16	203	65.0
20	20.000	27.519	25.000	1.692	1 1/8	1 1/4	20	8	169.4
500	508.0	699.0	635.0	43.0	1 1/8	1 1/4	20	203	77.0
24	24.000	32.031	29.500	1.889	1 1/4	1 3/8	20	8	286.9
600	609.6	813.6	749.3	48.0	1 1/4	1 3/8	20	203	130.4

L: Mfr's standard.

Pressure Performance Data

The following tables show maximum cold welded and corresponding working pressure working pressures (CWP) of Shurjoint R-88 for applicable steel pipe. couplings based on rings both sides fully

Model R-88 Ring Joint Coupling

Nominal Size	Pipe O.D.	Max. Working Pressure / Max. End Load Rings both sides fully welded					
		XS (.500")		STD (.375")		LW (.312")	
in	in	PSI	Lbs	PSI	Lbs	PSI	Lbs
mm	mm	Bar	kN	Bar	kN	Bar	kN
8	8.625	600	35040	400	23359	400	23359
200	219.1	42	150.74	28	105.51	28	105.51
10	10.750	600	54430	400	36287	400	36287
250	273.0	42	234.02	28	163.81	28	163.81
12	12.750	600	76567	400	51045	400	51045
300	323.9	42	329.42	28	230.59	28	230.59
200 JIS	8.516	600	34215	400	22772	400	22772
	216.3	42	150.58	28	102.83	28	102.83
250 JIS	10.528	600	52205	400	34803	400	34803
	267.4	42	224.52	28	157.16	28	157.16
300 JIS	12.539	600	74054	400	49369	400	49369
	318.5	42	318.53	28	222.97	28	222.97
14	14.000	600	92316	400	61544	350	53851
350 (R-88N)	355.6	42	397.06	28	277.94	24	238.23
16	16.000	500	100480	400	80384	350	70336
400 (R-88N)	406.4	35	453.78	28	363.02	24	311.16
18	18.000	500	12170	400	101736	350	89019
450 (R-88N)	457.2	35	574.31	28	459.45	24	393.82
20	20.000	500	157000	400	125600	300	94200
500 (R-88N)	508.0	35	709.03	28	567.22	20	405.16
24	24.000	500	226080	400	180864	250	113040
600 (R-88N)	609.6	35	1021.00	28	816.80	17	495.92
26	26.000	400	212264	300	159198	250	132665
650 (R-88N)	660.4	28	958.61	20	584.72	17	582.01
28	28.000	400	246176	300	184632	250	153860
700	711.2	28	1111.76	20	794.11	17	675.00
30	30.000	400	282600	300	211950	250	176625
750	762.0	28	1276.26	20	911.61	17	774.87
32	32.000	400	321536	300	241152	250	200960
800	812.8	28	1452.10	20	1037.21	17	881.63
34	34.000	350	317611	300	272238	200	181492
850	863.4	24	1404.45	20	1170.37	14	819.26
36	36.000	350	356076	300	305208	200	203472
900	914.4	24	1575.26	20	1312.72	14	918.90
38	38.000	300	340062	232	262981	175	198370
950	965.2	20	1462.63	16	1170.10	12	877.58
40	40.000	300	376800	232	291392	175	219800
1000	1016.0	20	1620.64	16	1296.51	12	972.39
42	42.000	300	415422	232	321260	175	242330
1050	1066.8	20	1786.76	16	1429.41	12	1072.05
44	44.000	300	455928	232	352584	175	265958
1100	1117.6	20	1960.98	16	1568.78	12	1176.59
48	48.000	300	542592	232	419604	---	---
1200	1219.2	20	2333.72	16	1866.98	---	---
52	52.000	232	492452	175	371462	---	---
1300	1320.8	16	2191.11	12	1643.33	---	---
54	54.000	232	531062	175	400586	---	---
1350	1371.6	16	2362.90	12	1772.17	---	---
56	56.000	232	571128	175	430808	---	---
1400	1422.4	16	2541.17	12	1905.87	---	---
60	60.000	232	656532	175	494550	---	---
1500	1524.0	16	2917.16	12	2187.87	---	---
66	66.000	175	598406	125	427433	---	---
1650	1676.4	12	2647.32	9	1897.24	---	---
68	68.000	175	635222	125	453730	---	---
1700	1727.2	12	2810.19	9	2013.97	---	---
72	72.000	150	610416	125	508680	---	---
1800	1828.8	10	2625.44	9	2257.88	---	---
84	84.000	125	692370	100	553896	---	---
2100	2133.6	9	3073.22	7	2501.46	---	---
96	96.000	125	904320	100	723456	---	---
2400	2438.4	9	4014.01	7	3267.21	---	---

Shurjoint Shouldered Piping System

The **Shurjoint** shouldered piping system is a classic and versatile piping method used for a wide range of applications including irrigation, dewatering on construction sites, and other installations, etc. The shouldered system features full flow characteristics, provides speed and ease of installation, and proven reliability. The system provides for limited expansion and contraction and accommodates some linear and angular movement. Each joint is a union.

The **Shurjoint** shouldered piping system utilizes Type A weld-on rings, manufactured from mild steel or material compatible to pipe end used.

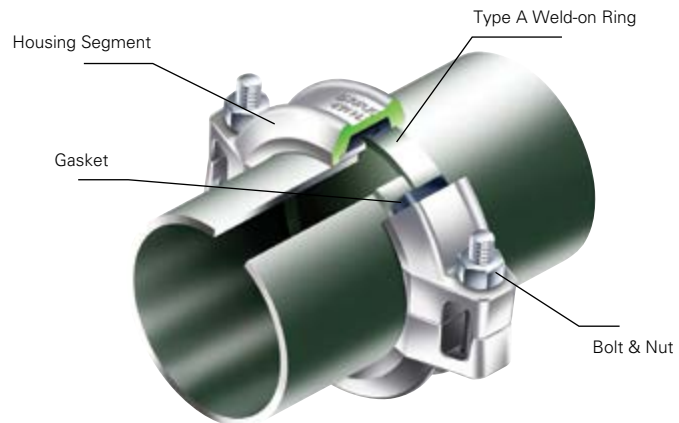

Shoulder Dimensions (Type A Weld-on Rings)

The **Shurjoint** shouldered piping system utilizes Type A weld-on rings, manufactured from mild steel or material compatible to pipe end used. Type A rings are suitable for services up to maximum 600 psi (40 Bar) for sizes up to 4" (100 mm) and 400 psi (28 Bar) for 5" (125 mm) through 8" (200 mm).

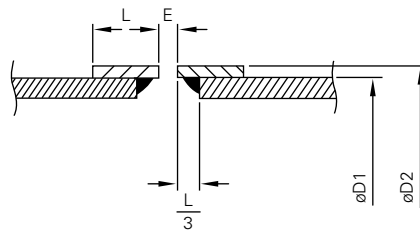

Nominal Size	Pipe O.D. φ D1	Shoulder Dia. φ D2	Shoulder Length L	Nominal Gap E
in	in	in	in	in
mm	mm	mm	mm	mm
2	2.375	2.618	0.625	0.125
50	60.3	66.5	16.0	3.2
3	3.500	3.819	0.625	0.125
80	88.9	97.0	16.0	3.2
4	4.500	4.803	0.688	0.125
100	114.3	122.0	17.5	3.2
165.1 mm	6.500	6.870	0.688	0.125
	165.1	174.5	17.5	3.2
6	6.625	7.007	0.688	0.125
150	168.3	178.0	17.5	3.2
8	8.625	9.134	0.813	0.125
200	219.1	232.0	20.6	3.2
10	10.750	11.260	0.813	0.125
250	273.0	286.0	20.6	3.2
12	12.750	13.248	0.813	0.125
300	323.9	336.5	20.6	3.2

Note: The exterior surface and the edge of the shouldered pipe ends must be free from any indentations, projections or other harmful surface defects such as weld splatters, any lumps of galvanizing, rust, dirt and score marks. Shouldered rings must be contacted or near tight to the pipe. The "stand off length*" must be accurately consistent in the circumference.
 (*:The distance between the edge of the Shouldered ring and the pipe end (1/3 the shoulder length 'L').

Model S35 Shouldered Flexible Coupling

The Shurjoint Model S35 coupling is a flexible type shouldered coupling for general applications for use on Type A shouldered pipe ends. The housing segments are made of ductile iron to ASTM A536 Gr. 65-45-12 and or A395 Gr. 65-45-15 and are normally supplied in hot-dip galvanized. The standard rubber gasket is Grade T Nitrile.

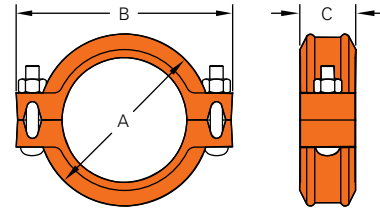

Nominal Size	Pipe O.D.	Working Pressure (CWP)*	Dimensions			Allowable Pipe End Separation	Deflection	Bolt Size	Weight
			A	B	C				
in	in	PSI	in	in	in	in	Deg. (°)	in	Lbs
mm	mm	Bar	mm	mm	mm	mm			Kgs
2	2.375	600	3.90	5.47	1.81	0.13	2° 43'	3/8" x 2 1/8"	2.4
50	60.3	40	99.0	139.0	46.0	3.2			1.1
3	3.500	600	5.08	6.61	1.81	0.13	1° 53'	1/2" x 3"	3.3
80	88.9	40	129.0	168.0	46.0	3.2			1.5
4	4.500	600	6.26	7.87	1.97	0.13	1° 29'	1/2" x 3"	4.9
100	114.3	40	159.0	200.0	50.0	3.2			2.2
165.1 mm	6.500	600	8.39	10.50	1.97	0.13	1° 2'	5/8" x 3 1/2"	7.7
	165.1	40	213.0	267.0	50.0	3.2			3.5
6*	6.625	600	8.62	11.00	1.97	0.13	1° 1'	5/8" x 3 1/2"	8.4
150	168.3	40	219.0	279.0	50.0	3.2			3.8
8	8.625	600	10.75	13.19	2.36	0.13	0° 47'	3/4" x 4 3/4"	13.0
200	219.1	40	273.0	335.0	60.0	3.2			5.9
10*	10.750	300	13.20	15.62	2.56	0.13	0° 47'	3/4" x 4 3/4"	19.8
250	273.0	20	335.4	396.8	65.0	3.2			9.0
12*	12.750	300	15.19	17.72	2.56	0.13	0° 47'	3/4" x 4 3/4"	22.9
300	323.9	20	385.8	450.1	65.0	3.2			10.4

* Non-standard/stock items may require longer lead time.

Model SD-28A Shouldered Toggle Coupling

The Shurjoint Model SD-28A coupling is designed to connect shouldered-end pipe with Type A rings for services where frequent assembly and disassembly is desired or required. The housing segments are hinged with a lever handle for easy installation. The use of a split pin prevents

accidental opening of the couplings. The housing segments are made of ductile iron to ASTM A536 Gr. 65-45-12 and or A395 Gr. 65-45-15 and are normally supplied in hot-dip galvanized. The standard rubber gasket is Grade T Nitrile.

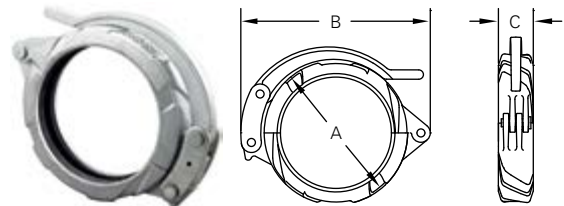

Nominal Size	Pipe O.D.	Working Pressure (CWP)**	Dimensions			Allowable Pipe End Separation	Deflection	Weight
			A	B	C			
in	in	PSI	in	in	in	in	Deg. (°)	Lbs
mm	mm	Bar	mm	mm	mm	mm		Kgs
2*	2.375	400	39.32	4.43	1.93	0.125	2° - 43'	2.8
50	60.3	28	86.5	112.5	49	3.2		1.3
3*	3.500	400	4.96	6.46	1.93	0.125	1° - 53'	4.4
80	88.9	28	126.0	164.0	49	3.2		2.0
4	4.500	400	6.30	8.43	2.05	0.125	1° - 29'	6.6
100	114.3	28	160.0	214.0	52	3.2		3.0
6*	6.500	400	8.43	11.14	2.05	0.125	1° - 2'	6.5
150	165.1	28	214.0	283.0	52	3.2		4.3
6	6.625	400	8.54	11.10	2.05	0.125	1° - 1'	9.9
150	168.3	28	217.0	282.0	52	3.2		4.5
8*	8.625	400	10.95	14.17	2.36	0.125	0° - 47'	18.3
200	219.1	28	278.0	360.0	60	3.2		8.3

* Non-standard/stock items may require longer lead time.

** Working pressure is based on standard wall carbon steel pipe.

Plain-End Piping System for Steel Pipe

Model

79 Wildcat Coupling

The Shurjoint Model 79 Wildcat Coupling is designed to mechanically join plain-end or beveled end carbon steel pipe. The Wildcat couplings can be used for a variety of applications including mining, process piping, manifold piping and oilfield services. The Wildcat couplings feature case-hardened jaws* within the housings and large diameter heat treated track bolts that when tightened securely grip the pipe surface. As with grooved couplings, a C-shaped rubber gasket effectively seals the

pipe ends (* For sizes larger than 14" (350 mm) , jaws are made of 17-4PH stainless steel.)

The Model 79 coupling is recommended for use on carbon steel pipe with a hardness less than HB150, not recommended for stainless steel, plastic, HDPE, cast iron or other brittle pipe.

Gaskets are available either in Grade E EPDM for water services of -29°F to +230°F (-34°C to +110°C) or Grade T Nitrile for oil services -20°F to +180°F (-29°C to +82°C).

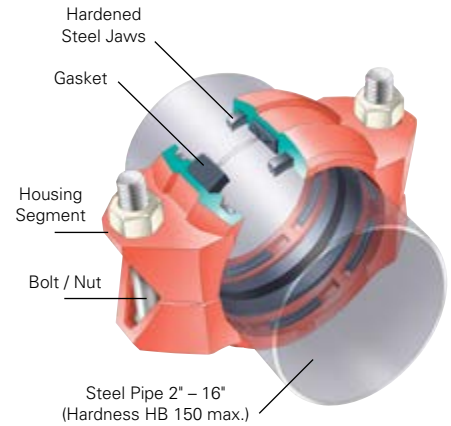

Bolts and nuts must always be tightened to the required torque.

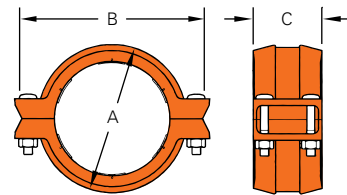
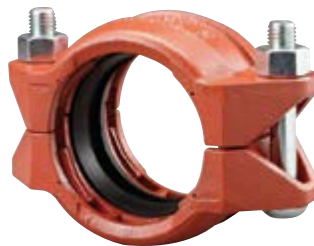

Nominal Size	Pipe O.D.	Max. Working Pressure*	Max. End Load	Required Bolt Torque	Bolt		Dimensions			Weight
					No.	Size	A	B	C	
in	in	PSI	Lbs	Lbs-Ft		in	in	in	Lbs	
mm	mm	Bar	kN	Nm		mm	mm	mm	Kgs	
1	1.315	750	1020	110	2	½ x 2¾	2.60	4.37	3.05	3.3
25	33.4	52	4.55	150			66	111	78	1.5
1½	1.900	750	2130	110	2	½ x 2¾	3.15	5.08	3.05	3.9
40	48.3	52	9.52	150			80	129	78	1.8
2	2.375	750	3320	150	2	¾ x 3½	3.75	5.94	3.54	7.0
50	60.3	52	14.84	200			95	151	90	3.2
2½	2.875	600	3890	150	2	¾ x 3½	4.25	6.46	3.54	7.3
65	73.0	42	17.57	200			108	164	90	3.3
3	3.500	600	5770	200	2	¾ x 4¾	5.00	7.48	3.54	11.0
80	88.9	42	26.06	270			127	190	90	5.0
4	4.500	450	7150	200	2	¾ x 4¾	6.14	8.78	4.00	14.3
100	114.3	31	32.82	270			154	223	102	6.5
5	5.563	300	7290	250	2	7⁄8 x 6½	7.36	10.31	4.38	24.2
125	141.3	20	32.91	340			187	262	111	11.0
6	6.625	300	10340	250	2	7⁄8 x 6½	8.50	11.50	4.38	28.6
150	168.3	20	46.69	340			216	292	111	13.0
8	8.625	250	14600	200	4	¾ x 4¾	10.88	14.02	5.00	41.8
200	219.1	17	64.06	270			276	356	127	19.0
10	10.750	250	22680	300	4	7⁄8 x 6½	12.60	16.14	5.00	52.8
250	273.0	17	99.46	400			320	410	127	24.0
12	12.750	250	31900	350	4	1 x 6½	14.60	18.54	5.00	63.1
300	323.9	17	140.00	470			371	471	127	28.7
14	14.000	200	30770	350	4	1 x 6½	16.70	20.00	5.28	93.5
350	355.6	14	138.97	470			424	508	134	42.5
16	16.000	150	30140	350	4	1 x 6½	18.70	22.00	5.28	95.7
400	406.4	10	129.65	470			475	559	134	43.5

* Working pressure is for plain-end standard wall steel pipe with hardness less than HB150.

Section 7

HDPE Series

HDPE Series	156
H305 HDPE Coupling	157
H307 HDPE Transition Coupling.....	158
H312 HDPE Flange Adapter	159

HDPE Series

Shurjoint offers a series HDPE couplings and adapters for joining HDPE pipe. The use of HDPE (high density polyethylene) pipe continues to grow in popularity as its benefits over traditional materials are realized in a variety of service applications. The benefits of an HDPE pipe system include a longer service life, increased flexibility, reduced weight, increased resistance to corrosion, chemicals, and fatigue, as well as superior flow characteristics. HDPE is now commonly used in service applications including municipal water and waste water, water distribution and transport, mining, slurry and many other general and industrial applications.

Shurjoint HDPE couplings provide a fast and easy way to mechanically join HDPE pipe. A series of sharply machined teeth securely grip the pipe as the bolts are tightened, resulting in a leak-free joint. The **Shurjoint** joining method eliminates the need for costly heat fusion equipment. The highly restrained joint allows long lengths of pipe to be pulled from one area to another. With the removal of a few bolts one can easily access the system for cleaning, maintenance, changes and or system expansion.

Shurjoint HDPE couplings are designed to join IPS HDPE pipe, DR32.5 to 7.3, conforming to ASTM D2513, D3350 and/or ANSI/AWWA C901, and ISO HDPE pipe, SDR 9 to 26, conforming to ISO 4427-1/2.

As the ductile iron coupling is much stronger than HDPE pipe itself, pressure ratings of HDPE couplings are determined by the pressure rating of HDPE pipe used. Pressure ratings of HDPE pipe vary depending on DR or SDR (standard dimension ratio) and design stress of the material.



How to install



Marking: Use a marker and measuring tape to place "Gasket Centering Marks" and "Coupling Centering Marks" on each pipe end per the installation instructions.



Install Gasket: Place a gasket over the pipe ends and center the gasket in between the first set gasket centering marks. The pipe ends should always be butted against each other.



Mount Housings: Place the housings over the gasket, ensure the gasket stays centered between the first set marks made on the pipe ends and the housings are properly centered between the second set coupling center marks. Also make sure that housing tongue and groove (T&G) mate correctly.



Tighten Nuts: Tighten nuts alternately and equally until the bolt pads meet and make metal-to-metal contact. Repeated alternate tightening will reduce tightening torque considerably. Tighten nuts by another one quarter to one half turn to make sure the bolts and nuts are snug and secure.



Refer to the **Shurjoint** installation instruction manual for complete instructions. **Shurjoint** HDPE couplings are not intended for use on PVC, PP or other materials. Do not use standard soap based lubricant on HDPE pipe. **Shurjoint** recommends the use of a silicone based lubricant with the HDPE series. In order to avoid injuries from the sharp machined teeth, wear gloves when handling.

Pressure Ratings (psi) - IPS Size

Pipe Dimension Ratio (DR)	PE4710 PE100	PE3608 PE3408
DR 7.3	317	265
DR 9	250	200
DR 11	200	160
DR 13.5	160	130
DR 17	125	100
DR 21	100	80
DR 26	80	65
DR 32.5	63	50

Design stress: PE4710 1000 psi, PE3608 & 3408 800 psi

$$DR \text{ (Pipe Dimension Ratio)} DR = \frac{D}{t}$$

Where:

D = pipe outside diameter, in
t = pipe minimum wall thickness, in

Pressure Ratings (Bar) - ISO Size

Pipe Dimension Ratio (SDR)	PE100	PE80
SDR 9	20	16
SDR 11	16	10
SDR 17	10	6.3
SDR 26	6.3	4

Design Stress: PE100 8.0 MPa, PE80 5.0 MPa

$$SDR \text{ (Standard Dimension Ratio)} SDR = \frac{D}{t}$$

Where:

D = pipe outside diameter, mm
t = pipe minimum wall thickness, mm

Model H305 HDPE Coupling

The Shurjoint Model H305 HDPE Couplings feature four bolt housings and a series of sharply machined teeth which securely grip the pipe as the bolts and nuts are tightened. The result is a leak-tight joint that is as strong as or stronger than the pipe itself. The H305 also features a contoured housing with integral ramps along the outside diameter to help the coupling slide over most obstacles during the relocation of pipe runs.

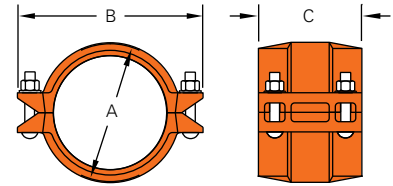

H305 - IPS Size

Nominal Size	Pipe O.D.	Dimensions			Bolt		Weight
		A	B	C	No.	Size	
in	in	in	in	in		in	Lbs
mm	mm	mm	mm	mm			Kgs
2	2.375	3.39	5.24	4.57	4	½ x 2¾	5.7
50	60.3	86	133	116	4	½ x 2¾	2.6
3	3.500	4.61	6.50	4.57	4	½ x 3	7.9
80	88.9	117	165	116	4	½ x 3	3.6
4	4.500	5.75	7.95	5.75	4	½ x 3	11.4
100	114.3	146	202	146	4	½ x 3	5.2
5	5.563	6.66	8.25	4.63	4	½ x 3	9.9
125	141.3	169	210	118	4	½ x 3	4.5
6	6.625	7.87	10.75	5.87	4	⅝ x 3½	18.0
150	168.3	200	273	149	4	⅝ x 3½	8.2
8	8.625	10.39	13.11	6.02	4	⅝ x 3½	28.4
200	219.1	264	333	153	4	⅝ x 3½	12.9
10	10.750	12.52	15.71	6.50	4	¾ x 4¾	43.6
250	273.0	318	399	165	4	¾ x 4¾	19.8
12	12.750	14.37	17.80	7.09	4	¾ x 4¾	56.1
300	323.9	365	452	180	4	¾ x 4¾	25.5
14	14.000	16.26	19.25	10.08	4	1 x 4½	90.6
350	355.6	413	489	256	4	1 x 4½	41.2
16	16.000	18.39	21.30	10.08	4	1 x 4½	97.2
400	406.4	467	541	256	4	1 x 4½	44.2
18	18.000	20.28	23.43	10.08	4	1 x 4½	111.1
450	457.2	515	595	256	4	1 x 4½	50.5
20	20.000	22.36	25.63	10.08	4	1 x 4½	136.0
500	508.0	568	651	256	4	1 x 4½	61.8

* Shurjoint recommends the use of a silicone based lubricant for the HDPE series.

H305 - ISO Size

Pipe O. D.		Dimensions			Bolt		Weight
Min.	Max.	A	B	C	No.	Size	
mm	mm	mm	mm	mm		mm	Kgs
50	50.5	72	115	105	4	M10 x 55	1.5
63	63.6	85	128	105	4	M10 x 55	1.9
75	75.7	97	140	105	4	M10 x 55	2.4
90	90.9	113	169	105	4	M12 x 75	3.3
110	111.0	139	181	112	4	M12 x 75	4.1
140	141.3	169	210	118	4	M12 x 75	4.5
160	161.5	190	232	118	4	M12 x 97	5.6
180	181.7	211	253	118	4	M12 x 97	7.5
200	201.8	236	305	127	4	M16 x 90	9.4
225	226.4	261	330	127	4	M16 x 90	11.3
250	252.3	289	351	134	4	M16 x 110	12.7
280	281.7	319	406	134	4	M20 x 120	18.4
315	317.9	354	438	134	4	M20 x 120	16.7
355	357.2	412	489	256	4	M24 x 110	41.2
400	402.4	462	540	256	4	M24 x 110	44.2
450	452.7	515	595	256	4	M24 x 110	57.7

* Shurjoint recommends the use of a silicone based lubricant for the HDPE series.

Model H307 HDPE Transition Coupling

The Shurjoint Model H307 transition coupling provides for a fast, easy and direct transition from HDPE pipe and or fittings to grooved end steel pipe (IPS).

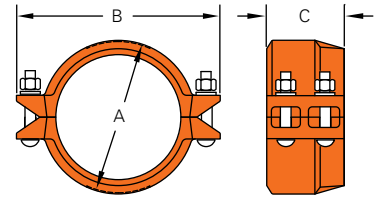

H307 - IPS Size

Nominal Size	Pipe O.D.	Dimensions			Bolt		Weight
		A	B	C	No.	Size	
in	in	in	in	in			Lbs
mm	mm	mm	mm	mm		in	Kgs
2	2.375	3.39	5.79	3.11	4	½ x 2¾	4.4
50	60.3	86	147	79	4	½ x 3	2.0
3	3.500	4.49	6.89	3.11	4	½ x 3	5.9
80	88.9	114	175	79	4	½ x 3	2.7
4	4.500	5.75	8.23	3.74	4	½ x 3	8.4
100	114.3	146	209	95	4	½ x 3	3.8
6	6.625	8.00	11.02	3.74	4	¾ x 3½	12.5
150	168.3	203	280	95	4	¾ x 3½	5.7
8	8.625	10.51	13.46	4.25	4	¾ x 3½	21.3
200	219.1	267	342	108	4	¾ x 3½	9.7
10	10.750	12.64	16.69	5.00	4	¾ x 4¾	35.2
250	273.0	321	424	127	4	¾ x 4¾	16.0
12	12.750	14.76	19.02	5.00	4	¾ x 4¾	43.1
300	323.9	375	483	127	4	¾ x 4¾	19.6

*Shurjoint recommends the use of a silicone based lubricant for use with the HDPE series.

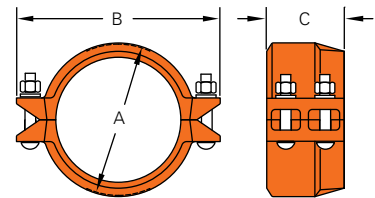

H307 - ISO Size

Pipe O.D.		Dimensions			Bolt		Weight
HDPE	IPS	A	B	C	No.	Size	
mm	mm	mm	mm	mm		mm	Kgs
63.0	60.3	86	146	73	4	M10 x 55	1.5
75.0	73.0	97	159	73	4	M10 x 55	1.9
90.0	88.9	114	178	73	4	M12 x 75	2.3
110.0	114.3	144	203	76	4	M12 x 75	2.8
160.0	165.1	194	254	76	4	M12 x 97	6.2
160.0	168.3	198	257	76	4	M12 x 97	6.2
200.0	219.1	256	321	85	4	M16 x 90	6.4
250.0	273.0	321	394	97	4	M20 x 120	11.9
315.0	323.9	375	451	97	4	M20 x 120	12.7

* Shurjoint recommends the use of a silicone based lubricant for the HDPE series.

Model H312 HDPE Flange Adapter

The Shurjoint Model H312 HDPE flange adapter provides for the direct transition from HDPE pipe and or fittings to ANSI Class 125 or 150 flanged components.

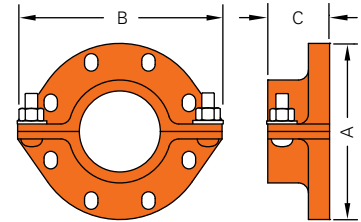

H312 - IPS Size / ANSI Class 125/150

Nominal Size	Pipe O.D.	Dimensions			Draw Bolt / Nut		Flange Bolt / Nut *		Weight
		A	B	C	No.	Size	No.	Size	
in	in	in	in	in		in		Lbs	
mm	mm	mm	mm	mm				Kgs	
3	3.500	7.75	8.86	3.10	2	5/8 x 2 1/2	4	5/8	10.6
80	88.9	197	225	79					4.8
4	4.500	9.00	10.25	3.10	2	5/8 x 2 1/2	8	5/8	15.0
100	114.3	229	260	79					6.8
6	6.625	11.00	12.25	3.75	2	5/8 x 2 1/2	8	3/4	21.5
150	168.3	279	311	95					9.8
8	8.625	13.50	14.75	3.42	2	3/4 x 2 3/4	8	3/4	28.8
200	219.1	343	375	87					13.1
10	10.750	16.00	21.00	4.25	4	3/4 x 2 3/4	12	7/8	42.9
250	273.0	406	533	108					19.5
12	12.750	19.02	24.00	4.25	4	3/4 x 2 3/4	12	7/8	51.5
300	323.9	483	610	108					23.4

* Shurjoint recommends the use of a silicone based lubricant for use with the HDPE series.

* Flange bolts and nuts are to be supplied by installer.

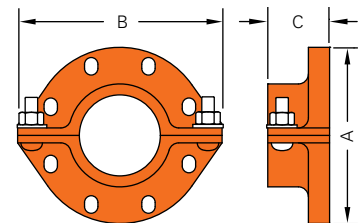

H312 - ISO Size / PN 10 / PN 16

Pipe O.D.		Dimensions			Draw Bolt / Nut		Flange Bolt / Nut *		Weight
HDPE	Steel	A	B	C	No.	Size	No.	Size	
mm	mm	mm	mm	mm		mm		mm	
63	60.3	165	197	79	2	M16 x 54	4	M16	4.3
90	88.9	200	241	79	2	M16 x 54	8	M16	4.8
110	114.3	220	260	79	2	M16 x 54	8	M16	6.8
160	165.1	285	330	82	2	M20 x 60	8	M20	9.8
200	219.1	340	400	108	2	M20 x 60	12 (PN 16)	M20	13.1
250	273.0	405	533	108	4	M24 x 100	12	M24	19.5
315	323.9	460	587	108	4	M24 x 100	12	M24	28.5

* Shurjoint recommends the use of a silicone based lubricant for use with the HDPE series.

* Flange bolts and nuts are to be supplied by installer.

Section 8

Copper Series

Grooved Couplings, Fittings & Components for Copper Tubing	164
Pressure Ratings of Copper Tubing	164
Standard Roll Groove for U.S. Standard Copper Tubing	164
Grooved Couplings & Flanges for Copper Tubing	
C305 Rigid Coupling	165
C306 / 96 Reducing Coupling & Continuity Clip	166
C307 Transition Coupling	167
C341 Flange Adapter	167
Grooved Fittings for Copper Tubing	
C10 / C11 / C20 / C60 Elbows, Tee & Cap	168
C21 / C50 / C26 Reducing Tees & Concentric Reducer	169
C52 / C55 Concentric Reducer & Transition Adapter	170
C55T / DE30-GG Transition Adapters & Dielectric Transition Fitting ..	171
Mechanical Tees & Flow Control Components	
C723 Mechanical Tee.....	172
C726 Y-Strainer	173
SJ-C300 Butterfly Valve.....	174

Grooved Couplings, Fittings & Components for Copper Tubing

The **Shurjoint** copper series is the most complete line of grooved components available for installation on copper tubing (CTS) in sizes 2" - 6" (50 mm - 150 mm) **Shurjoint** grooved mechanical components provide a fast, easy, economical and durable joining method of copper tubing without the use of heat or solder.

Grooved-end fittings are produced from wrought copper and or bronze castings. Wrought copper conforms to ASTM B75 UNC C12200 (99.9% copper). Bronze castings are produced from lead-free alloys C83470 and or C89836 bismuth copper alloy per ASTM B584. Materials are in compliance with NSF/ANSI 61 and NSF/ANSI 372 for potable water service applications.

Copper Tubing - Dimensions & Pressure Ratings (ASTM B88 & B306)

Nominal Size	Type	D Pipe O.D.	t Thickness		P Max. Pressure	
			in	mm	PSI	Bar
2	K	2.125	0.083	2.11	484	33
	L		0.070	1.78	406	28
50	M	54	0.058	1.47	335	23
	DWV		0.042	1.07	241	17
2½	K	2.625	0.095	2.41	4473	1
	L		0.080	2.03	375	26
65	M	66.7	0.065	1.65	303	21
	DWV		N/A	N/A	N/A	N/A
3	K	3.125	0.109	2.77	431	30
	L		0.090	2.29	354	24
80	M	79.4	0.072	1.83	282	19
	DWV		0.045	1.14	175	12
4	K	4.125	0.134	3.40	400	28
	L		0.110	2.79	327	23
100	M	104.8	0.095	2.41	282	19
	DWV		0.058	1.47	171	12
5	K	5.125	0.160	4.06	384	26
	L		0.123	3.12	294	20
125	M	130.2	0.109	2.77	260	18
	DWV		0.072	1.83	171	12
6	K	6.125	0.192	4.88	386	27
	L		0.140	3.56	279	19
150	M	155.6	0.122	3.10	243	17
	DWV		0.083	2.11	164	11

Notes: 1. Design stress: 6000 psi (41.4 MPa)
2. Pressures are based on water at 73.4°F (23°C).



Roll Set

As copper tubing is thinner than carbon steel pipe, always use a roll set specifically designed for use on copper tubing.

Pipe O.D.

Maximum allowable tolerances from square cut ends is 0.03" for 2" thru 3"; 0.045" for 4" thru 6"; and 0.060" for sizes 8".

Gasket Seating Surface

The gasket seating surface shall be free from deep scores, marks, or ridges that would prevent a positive seal.

Groove Width

Groove width is to be measured between vertical flanks of the groove side walls.

Groove Diameter

The "C" diameters are average values. The groove must

be of uniform depth around the entire pipe circumference.

Groove Depth

The "d" is for reference use only. The groove dimension shall be determined by the groove diameter "C".

Minimum Wall Thickness

The DWV pipe (ASTM B-306) is minimum wall thickness that may be roll grooved.

Flare Diameter

The pipe end that may flare when the groove is rolled shall be within this limit when measured at the extreme end of the pipe.

Standard Roll Groove for U.S. Standard Copper Tubing

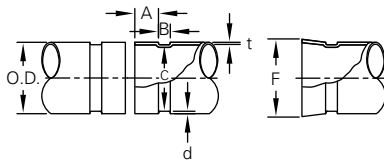

Nominal Size	Pipe O.D. Basic Size	A Gasket Seat ±0.03 / ±0.79	B Groove Width ±0.03 / ±0.79	C Groove Dia. +0/-0.02 / +0/-0.51	d Groove Depth (ref.)	t Min. Allowed Wall Thick.	F Max. Allowed Flare Dia.
in	in	in	in	in	in	in	in
mm	mm	mm	mm	mm	mm	mm	mm
2	2.125	0.610	0.300	2.029	0.048	0.064	2.220
50	54.0	15.5	7.6	51.5	1.2	1.6	56.4
2½	2.625	0.610	0.300	2.525	0.050	0.065	2.720
65	66.7	15.5	7.6	64.1	1.3	1.7	69.1
3	3.125	0.610	0.300	3.025	0.050	DWV	3.220
80	79.4	15.5	7.6	76.8	1.3		81.8
4	4.125	0.610	0.300	4.019	0.053	DWV	4.220
100	104.8	15.5	7.6	102.1	1.4		107.2
5	5.125	0.610	0.300	4.999	0.053	DWV	5.220
125	130.2	15.5	7.6	127.0	1.4		132.6
6	6.125	0.610	0.300	5.999	0.063	DWV	6.220
150	155.6	15.5	7.6	152.3	1.6		158.0

Model

C305 Rigid Coupling for Copper Tubing (CTS)

The Model C305 features angle bolt pad design for a rigid joint and easy swing-over installation. The C305 couplings are comprised of epoxy coated ductile iron

housings and EPDM GapSeal gaskets and are rated up to 300 psi (20 Bar), depending on the type and size of copper tubing used.

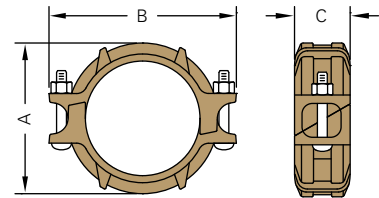

TYPE K, L, M (ASTM B-88) & TYPE DWV (ASTM B306)

Nominal Size	Pipe O.D.	Max. Working Pressure (CWP)*	Max. End Load (CWP)	Pipe End Separation	Dimensions			Bolt Size	Weight
					A	B	C		
in	in	PSI	in	in	in	in	in	in	Lbs
mm	mm	Bar	mm	mm	mm	mm	mm		Kgs
2	2.125	300	1060	0.06	3.17	4.63	1.89	$\frac{3}{8} \times 2\frac{1}{2}$	1.8
50	54.0	20	4.58	1.5	81	118	48	$\frac{3}{8} \times 2\frac{1}{2}$	0.8
2½	2.625	300	1620	0.06	3.66	5.28	1.89	$\frac{3}{8} \times 2\frac{1}{2}$	2.0
65	66.7	20	6.98	1.5	93	134	48	$\frac{3}{8} \times 2\frac{1}{2}$	0.9
3	3.125	300	2290	0.06	4.21	6.06	1.89	$\frac{1}{2} \times 3$	2.8
80	79.4	20	9.90	1.5	107	154	48	$\frac{1}{2} \times 3$	1.3
4	4.125	300	4000	0.06	5.20	7.28	1.89	$\frac{1}{2} \times 3$	3.5
100	104.8	20	17.24	1.5	132	185	48	$\frac{1}{2} \times 3$	1.6
5	5.125	300	6180	0.06	6.26	8.66	1.89	$\frac{3}{8} \times 3\frac{1}{2}$	4.6
125	130.2	20	26.61	1.5	159	220	48	$\frac{3}{8} \times 3\frac{1}{2}$	2.2
6	6.125	300	8830	0.06	7.24	9.76	1.89	$\frac{3}{8} \times 3\frac{1}{2}$	5.5
150	155.6	20	38.01	1.5	184	248	48	$\frac{3}{8} \times 3\frac{1}{2}$	2.5

* Working pressure is for connection with roll-grooved Type K copper tubing.

Notes / Options: Couplings with rubber gaskets are likely to function as an insulator. Where electrical continuity is required, the Shurjoint Model 96 Continuity Clip will restore electrical continuity to the system. The continuity clip satisfies IEE Wiring Regulations.

BS EN 1057

Nominal Size	Pipe O.D.	Pipe End Separation	Dimensions			Bolt Size	Weight
			A	B	C		
mm	mm	mm	mm	mm	mm	mm	Kgs
50	54.0	1.5	81	118	48	M10 x 55	0.8
65	66.7	1.5	93	134	48	M10 x 55	0.9
80	76.1	1.5	104	136	48	M10 x 55	1.3
100	108.0	3.2	138	176	48	M12 x 75	1.6
125	133.0	3.2	165	220	48	M16 x 90	2.2
150	159.0	3.2	190	248	48	M16 x 90	2.5

Model

C306 Reducing Coupling for Copper Tubing (CTS)

The Model C306 Reducing Coupling allows direct reduction on a piping run and eliminates the need for a concentric reducer and couplings. The epoxy coated ductile iron coupling housings help eliminate galvanic local cell and stray current problems. The specially designed rubber gasket prevents the smaller pipe from telescoping into the larger pipe during vertical installation.

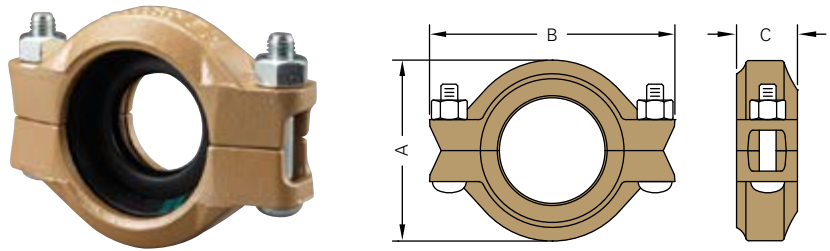

Nominal Size	Pipe O.D.	Max. Working Pressure (CWP)*	Max. End Load (CWP)	Pipe End Separation	Deflection		Dimensions			Bolt Size	Weight
					Deg. Per Coupling	Pipe	A	B	C		
in mm	in mm	PSI Bar	Lbs kN	in mm	(°)	in / ft mm / m	in mm	in mm	in mm	in	Lbs Kgs
2½ x 2	2.625 x 2.215	300	1622	0.06	1° - 22'	0.29	3.70	5.55	1.77	½ x 3	2.9
65 x 50	66.7 x 54.0	20	6.98	1.6		24.0	94	141	45		1.3
3 x 2	3.125 x 2.125	300	2300	0.06	1° - 09'	0.24	4.21	5.98	1.77	½ x 3	3.3
80 x 50	79.4 x 54.0	20	9.89	1.6		20.0	107	152	45		1.5
3 x 2½	3.125 x 2.625	300	2300	0.06	1° - 09'	0.24	4.21	5.98	1.77	½ x 3	3.0
80 x 65	79.4 x 66.7	20	9.89	1.6		20.0	107	152	45		1.4
4 x 2½	4.125 x 2.625	300	4007	0.06	0° - 53'	0.18	5.20	7.20	1.77	½ x 3	4.2
100 x 65	104.8 x 66.7	20	17.23	1.6		15.0	132	183	45		1.9
4 x 3	4.125 x 3.125	300	4007	0.06	0° - 53'	0.18	5.20	7.20	1.77	½ x 3	4.0
100 x 80	104.8 x 79.4	20	17.23	1.6		15.0	132	183	45		1.8
5 x 4	5.125 x 4.125	300	6186	0.06	0° - 42'	0.15	6.30	8.82	1.77	¾ x 3½	5.5
125 x 100	130.2 x 104.8	20	26.60	1.6		12.0	160	224	45		2.5
6 x 4	6.125 x 4.125	300	8835	0.06	0° - 36'	0.13	7.28	9.88	1.77	¾ x 3½	7.3
150 x 100	155.6 x 104.8	20	37.99	1.6		10.3	185	251	45		3.3

* Working pressure is for connection with roll-grooved Type K copper tubing.
 Notes / Options: Couplings with rubber gaskets are likely to function as an insulator. Where electrical continuity is required, the Shurjoint Model 96 Continuity Clip will restore electrical continuity to the system. The continuity clip satisfies IEE Wiring Regulations.

Model

96 Continuity Clip

Couplings with rubber gaskets are likely to function as an insulator. Where electrical continuity is required, the Shurjoint continuity clip will restore electrical continuity to the system. The electrical continuity clip satisfies IEE Wiring Regulations. Material: Copper or Brass plate.



Note: The pipe surface where continuity clips come in contact must be conductive. If the surface is painted, the paint should be removed to expose bare metal.

Model	Coupling Size	Carton Q'ty/pcs
96-1	1" - 3"	600
96-2	4" - 6"	600
96-3	8" - 12"	600

Model C307 Transition Coupling (IPS X CTS)

The Model C307 Transition Coupling provides for a direct connection and transition between grooved end IPS steel pipe, fittings or valves and grooved end CTS copper tubing. The rubber gasket isolates the fluid from coupling housings and the epoxy coated housings help eliminate galvanic local cell and stray current problems. The C307 is rated to 300 psi (20 Bar).

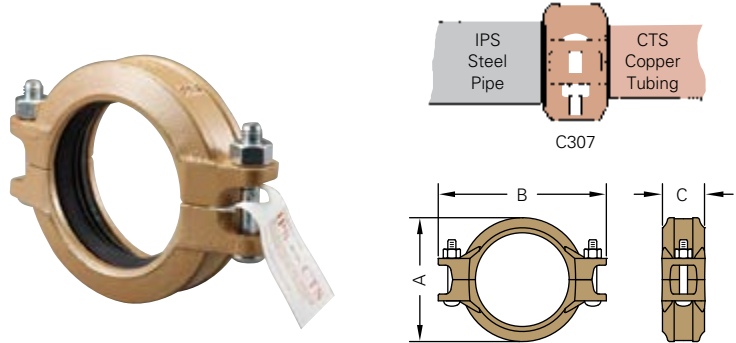

Nominal Size	Pipe O.D. IPS X CTS	Max. Working Pressure (CWP)*	Axial Displacement	Dimensions			Bolt Size	Weight
				A	B	C		
in	in	PSI	in	in	in	in	in	Lbs
mm	mm	Bar	mm	mm	mm	mm		Kgs
2	2.375 x 2.125	300	0 - 0.06	3.31	5.00	1.81	½ x 2½	2.0
50	60.3 x 54.0	20	0 - 1.6	84	127	46		0.9
2½	2.875 x 2.625	300	0 - 0.06	3.90	5.59	1.81	¾ x 2½	2.2
65	73.0 x 66.7	20	0 - 1.6	99	142	46		1.0
3	3.500 x 3.125	300	0 - 0.06	4.57	6.38	1.81	½ x 3	3.0
80	88.9 x 79.4	20	0 - 1.6	116	162	46		1.4
4	4.500 x 4.125	300	0 - 0.06	5.71	6.69	1.85	½ x 3	4.2
100	114.3 x 104.8	20	0 - 1.6	145	170	47		1.9
6	6.625 x 6.125	300	0 - 0.06	8.03	10.59	1.97	⅝ x 3½	7.3
150	168.3 x 155.6	20	0 - 1.5	204	269	50		3.3

* Working pressure is for connection with roll-grooved Type K copper tubing.

Notes / Options: Couplings with rubber gaskets are likely to function as an insulator. Where electrical continuity is required, the Shurjoint Model 96 Continuity Clip will restore electrical continuity to the system. The continuity clip satisfies IEE Wiring Regulations.

Model C341 Flange Adapter for Copper Tubing (CTS)

The Shurjoint Model C341 Flange Adapter allows for the direct connection of grooved-end copper tubing with ANSI Class 125/150 (steel) or ASME B16.24 (copper) Class 150 flanged components without the need for heat or solder. The pressure responsive gasket seals on the outside diameter of the copper tubing and isolates the flange segments from the internal fluid.

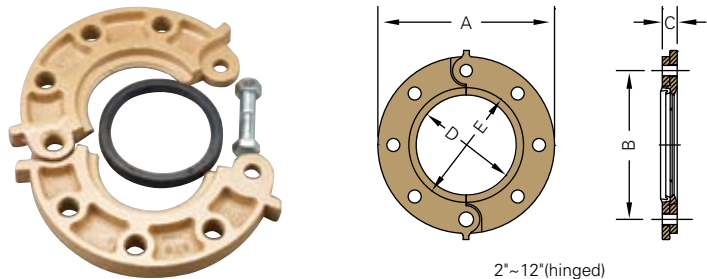

2"~12"(hinged)

Nominal Size	Pipe O.D.	Max. Working Pressure (CWP)*	Dimensions					Bolt		Weight
			A	B	C	D	E	No.	Size	
in	in	PSI	in	in	in	in	in		in	Lbs
mm	mm	Bar	mm	mm	mm	mm	mm			Kgs
2	2.125	300	6.00	4.75	0.75	2.13	3.20	4	⅝ x 3	4.6
50	54.0	20	152	121	19	54	81			2.1
2½	2.625	300	7.00	5.50	0.87	2.63	3.91	4	⅝ x 3	6.6
65	66.7	20	178	140	22	67	99			3.0
3	3.125	300	7.50	6.00	0.94	3.13	4.53	4	⅝ x 3	7.7
80	79.4	20	190	152	24	80	115			3.5
4	4.125	300	9.00	7.50	0.94	4.13	5.53	4	⅝ x 3	9.5
100	104.8	20	229	191	24	105	140			4.3
5	5.125	300	10.00	8.50	0.94	5.13	6.71			12.8
125	130.2	20	254	216	24	130	170	8	¾ x 3½	5.8
6	6.125	300	11.00	9.50	1.00	6.13	7.79	8	¾ x 3½	13.6
150	155.6	20	279	241	25	156	198			6.2

* Working Pressure is for connection with roll-grooved Type K copper tubing

** Please note that 2", 2½", and 3" Model C341 Flanges cannot be used for making direct connections to Model SJ-C300 Butterfly Valves due to bolt pad interference with the valve.

Grooved Fittings for Copper Tubing

Shurjoint Grooved-end fittings are produced from bronze castings. Bronze castings are produced from lead-free alloys C83470 or C89836 bismuth alloy per ASTM B584. Materials are in compliance with NSF/ANSI 61 and NSF/ANSI 372 for potable

water service applications. Shurjoint fittings are designed for use with Shurjoint CTS couplings, components and ASTM B88 roll grooved copper tubing type K, L, M and ASTM B-306 DWV.

Model

C10 90° Elbow

C11 45° Elbow

C20 Tee

C60 Cap

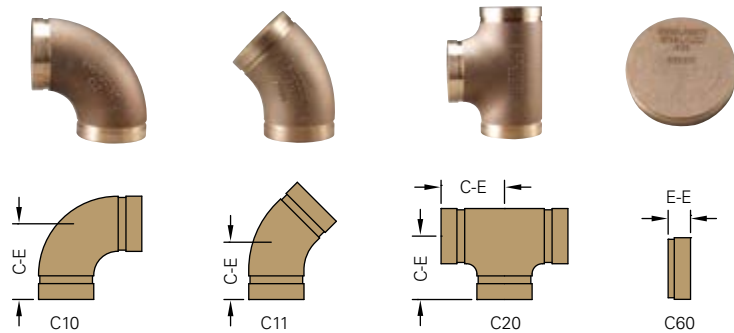

Nominal Size	Pipe O.D.	C10 90° Elbow		C11 45° Elbow		C20 Tee		C60 Cap	
		C-E	Weight	C-E	Weight	C-E	Weight	E-E	Weight
in	in	in	Lbs	in	Lbs	in	Lbs	in	Lbs
mm	mm	mm	Kgs	mm	Kgs	mm	Kgs	mm	Kgs
2	2.125	2.91	1.5	2.19	1.7	2.44	1.8	0.96	0.6
50	54.0	74	0.7	56	0.8	62	0.8	24	0.3
2½	2.625	3.31	2.0	2.31	2.1	3.20	2.9	0.96	0.9
65	66.7	84	0.9	59	1.0	81	1.3	24	0.4
3	3.125	3.81	2.6	2.59	3.2	3.50	3.7	0.96	1.2
80	79.4	97	1.2	66	1.4	89	1.7	24	0.6
4	4.125	4.75	5.5	3.35	5.5	4.25	7.3	0.96	2.1
100	104.8	121	2.5	85	2.5	108	3.3	24	1.0
5	5.125	5.94	11.5	3.25	7.9	5.94	17.2	0.96	3.5
125	130.2	151	5.2	83	3.6	151	7.8	24	1.6
6	6.125	6.94	16.5	3.63	10.2	6.94	26.2	0.96	4.4
150	155.6	176	7.5	92	4.6	176	11.9	24	2.0

Model
C21 Reducing Tee
C50 Concentric Reducer

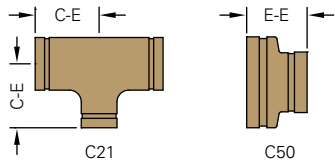

Nominal Size	Pipe O.D.	C21 Reducing Tee		C50 Concentric Reducer	
		C-E	Weight	E-E	Weight
in	in	in	Lbs	in	Lbs
mm	mm	mm	Kgs	mm	Kgs
2½ x 2	2.625 x 2.125	3.20	3.6	2.50	1.2
65 x 50	66.7 x 54.0	81	1.6	64	0.6
3 x 2	3.125 x 2.125	3.50	4.8	2.50	1.5
80 x 50	79.4 x 54.0	89	2.2	64	0.7
3 x 2½	3.125 x 2.625	3.50	4.8	2.50	1.5
80 x 65	79.4 x 66.7	89	2.2	64	0.7
4 x 2	4.125 x 2.125	4.25	7.7	3.00	2.5
100 x 50	104.8 x 54.0	108	3.5	76	1.2
4 x 2½	4.125 x 2.625	4.25	7.9	3.00	2.6
100 x 65	104.8 x 66.7	108	3.6	76	1.2
4 x 3	4.125 x 3.125	4.25	8.1	3.00	2.5
100 x 80	104.8 x 79.4	108	3.7	76	1.1
5 x 3	5.125 x 3.125	5.94	16.7	3.50	4.4
125 x 80	130.2 x 79.4	151	7.6	89	2.0
5 x 4	5.125 x 4.125	5.94	17.2	3.50	4.4
125 x 100	130.2 x 104.8	151	7.8	89	2.0
6 x 2½	6.125 x 2.625	6.94	22.9	4.00	6.0
150 x 65	155.6 x 66.7	176	10.4	102	2.7
6 x 3	6.125 x 3.125	6.94	23.5	4.00	6.0
150 x 80	155.6 x 79.4	176	10.7	102	2.7
6 x 4	6.125 x 4.125	6.94	23.5	4.00	5.8
150 x 100	155.6 x 104.8	176	10.7	102	2.7
6 x 5	6.125 x 5.125	6.94	26.2	4.00	5.9
150 x 125	155.6 x 130.2	176	11.9	102	2.7

Model
C26 Reducing Tee
(GR X GR X CUP)
(CAST)

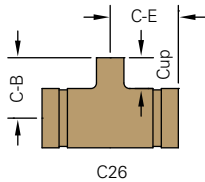

Nominal Size	C26 Red. Tee (Gr X Gr X Cup)			Weight
	C-E	C-B	Cup	
in	in	in	in	Lbs
mm	mm	mm	mm	Kgs
2 x 2 x ¾	2.20	1.97	0.75	1.6
50 x 50 x 20	56	50	19	0.7
2 x 2 x 1	2.33	2.2	0.91	1.6
50 x 50 x 25	59	56	23	0.7
2 x 2 x 1½	2.48	2.36	0.97	1.7
50 x 50 x 32	63	60	25	0.8
2 x 2 x 1½	2.56	2.28	1.09	2.0
50 x 50 x 40	65	58	28	0.9
2½ x 2½ x ¾	2.25	2.25	0.75	1.9
65 x 65 x 20	57	57	19	0.9
2½ x 2½ x 1	2.40	2.41	0.91	2.2
65 x 65 x 25	61	61	23	1.0
2½ x 2½ x 1½	2.52	2.55	0.97	2.3
65 x 65 x 32	64	65	25	1.1
2½ x 2½ x 1½	2.70	2.67	1.09	2.6
65 x 65 x 40	69	68	28	1.2
2½ x 2½ x 2	2.95	2.84	1.34	3.0
65 x 65 x 50	75	72	34	1.4
3 x 3 x ¾	2.44	2.50	0.75	2.9
80 x 80 x 20	62	64	19	1.3
3 x 3 x 1	2.55	2.80	0.91	2.9
80 x 80 x 25	65	71	23	1.3
3 x 3 x 1½	2.63	2.87	0.97	3.1
80 x 80 x 32	67	73	25	1.4
3 x 3 x 1½	2.85	2.99	1.09	3.3
80 x 80 x 40	72	76	28	1.5
3 x 3 x 2	3.11	3.09	1.34	3.7
80 x 80 x 50	79	78	34	1.7
4 x 4 x ¾	3.00	2.95	0.75	4.8
100 x 100 x 20	76	75	19	2.2
4 x 4 x 1	3.10	3.23	0.91	5.1
100 x 100 x 25	79	82	23	2.3
4 x 4 x 1½	3.25	3.46	0.97	5.5
100 x 100 x 32	83	88	25	2.5
4 x 4 x 1½	3.35	3.66	1.09	5.6
100 x 100 x 40	85	93	28	2.5
4 x 4 x 2	3.62	3.59	1.34	5.9
100 x 100 x 50	92	91	34	2.7

Model

C52 Concentric Reducer (GR X CUP) (CAST)

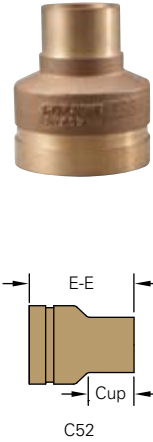

Nominal Size	C52 Conc. Reducer (Gr X Cup)		
	E-E	Cup	Weight
in	in	in	Lbs
mm	mm	mm	Kgs
2 x ¾	—	—	—
50 x 20	—	—	—
2 x 1	2.70	0.91	0.7
50 x 25	69	23	0.3
2 x 1¼	3.00	0.97	0.8
50 x 32	76	25	0.4
2 x 1½	2.94	1.09	0.8
50 x 40	75	28	0.4
2½ x ¾	—	—	—
65 x 20	—	—	—
2½ x 1	3.19	0.91	1.2
65 x 25	81	23	0.5
2½ x 1¼	3.19	0.97	1.2
65 x 32	81	25	0.5
2½ x 1½	3.19	1.09	1.2
65 x 40	81	28	0.5
2½ x 2	3.19	1.34	1.2
65 x 50	81	34	0.5
3 x ¾	—	—	—
80 x 20	—	—	—
3 x 1	—	—	—
80 x 25	—	—	—
3 x 1¼	—	—	—
80 x 32	—	—	—
3 x 1½	3.68	1.09	1.7
80 x 40	93	28	0.8
3 x 2	3.94	1.34	1.9
80 x 50	100	34	0.9
4 x ¾	—	—	—
100 x 20	—	—	—
4 x 1	—	—	—
100 x 25	—	—	—
4 x 1¼	—	—	—
100 x 32	—	—	—
4 x 1½	—	—	—
100 x 40	—	—	—
4 x 2	4.56	1.34	3.2
100 x 50	116	34	1.4

Model

C55 Transition Adapter (IPS X CTS)

The Shurjoint Model C55 Transition Adapter provides a direct transition between male threaded-end steel pipe (IPS) and grooved-end copper tubing. The C55 is UL classified to NSF/ANSI 61 and NSF/ANSI 372 for use in potable water systems.

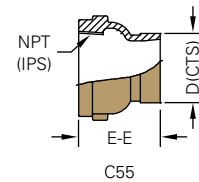

Nominal Size IPS (NPT) X CTS (GRV)	Actual Pipe O.D.		E-E	Weight
	Steel Pipe (IPS) O.D.	Copper Tubing (CTS) D		
in	in	in	in	Lbs
mm	mm	mm	mm	Kgs
1½ x 2	1.900	2.125	2.50	1.3
40 x 50	48.3	54.0	63	0.6
2 x 2	2.375	2.125	2.50	1.4
50 x 50	60.3	54.0	63	0.7
2½ x 2½	2.875	2.625	2.75	2.4
65 x 65	73.0	66.7	70	1.1
3 x 3	3.500	3.125	3.00	3.3
80 x 80	88.9	79.4	76	1.5

Model

C55T Transition Adapter (IPS/FT X CTS/GR) with ¼" Taps

Allows for the installation of gauges or Pete's Plugs for measuring temperature and or pressure.

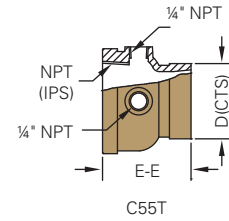
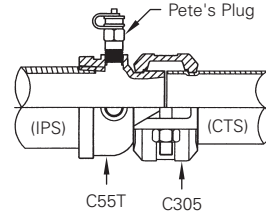

Nominal Size IPS (NPT) X CTS (GRV)	Steel Pipe (IPS) O.D.	Copper Tubing (CTS)		Weight
		D	E-E	
in	in	in	in	Lbs
mm	mm	mm	mm	Kgs
1½ x 2	1.900	2.125	2.50	1.1
40 x 50	48.3	54.0	63	0.5
2 x 2	2.375	2.125	2.50	1.3
50 x 50	60.3	54.0	63	0.6
2½ x 2½	2.875	2.625	2.75	2.0
65 x 65	73.0	66.7	70	0.9

Model

DE30-GG Dielectric Transition Fitting (IPS X CTS)

The Model DE30-GG Dielectric Transition Fitting provides a direct transition between grooved-end steel pipe (IPS) and grooved-end copper tubing (CTS). The internal PP lining effectively eliminates galvanic local cell and stray current problems.

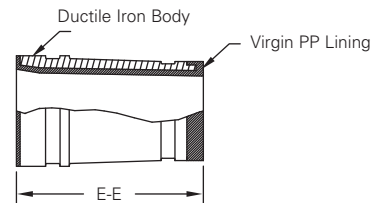

Nominal Size	Actual Pipe O.D.		E-E	Weight
	Steel Pipe	Copper Tubing		
in	in	in	in	Lbs
mm	mm	mm	mm	Kgs
2	2.375	2.125	4.00	1.3
50	60.3	54.0	102	0.6
2½	2.875	2.625	4.00	1.9
65	73.0	66.7	102	0.9
3	3.500	3.125	4.00	2.9
80	88.9	79.4	102	1.3
4	4.500	4.125	4.00	3.3
100	114.3	104.8	102	1.5
5	5.563	5.125	4.00	5.2
125	141.3	130.2	102	2.4
6	6.625	6.125	4.00	6.9
150	168.3	155.6	102	3.1
8	8.625	8.125	4.00	9.4
200	219.1	206.4	102	4.3

Model

C723 Bronze Mechanical Tee for Copper Tubing (CTS)

The Shurjoint Model C723 provides a fast, easy and reliable branch connection from copper tubing (CTS). The fitting consists of a bronze upper housing, ductile iron lower housing, o-ring and carbon steel track bolts and nuts. The fitting is available with a female threaded outlet, NPT or BSPT.

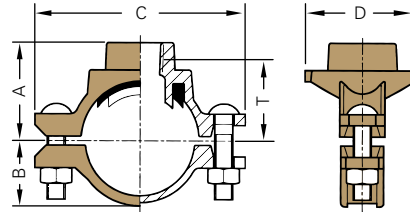

Nominal CTS X NPT	Max. Working Pressure (CWP)*	Hole Dia. +0.063, -0 / +1.6, -0	Dimensions					Bolt Size	Weight
			A	B	C	D	T**		
in mm	PSI Bar	in mm	in mm	in mm	in mm	in mm	in mm	in	Lbs Kgs
2½ x ½	200	1.18	2.56	1.61	4.65	1.89	2.09	¾ x 2½	1.5
65 x 15	14	30	65	41	118	48	53	¾ x 2½	0.7
2½ x ¾	200	1.18	2.56	1.61	4.65	2.01	2.05	¾ x 2½	1.5
65 x 20	14	30	65	41	118	51	52	¾ x 2½	0.7
2½ x 1	200	1.18	2.56	1.61	4.65	1.89	1.93	¾ x 2½	1.5
65 x 25	14	30	65	41	118	48	49	¾ x 2½	0.7
2½ x 1¼	200	1.77	2.68	1.61	4.65	2.64	2.15	¾ x 2½	2.2
65 x 32	14	45	68	41	118	67	55	¾ x 2½	1.0
3 x ¾	200	1.18	2.80	1.89	5.16	2.01	2.28	¾ x 2½	1.5
80 x 20	14	30	71	48	131	51	58	¾ x 2½	0.7
3 x 1	200	1.18	2.80	1.89	5.16	1.89	2.20	¾ x 2½	1.8
80 x 25	14	30	71	48	131	48	56	¾ x 2½	0.8
3 x 1¼	200	1.77	2.95	1.89	5.16	2.64	2.59	¾ x 2½	2.2
80 x 32	14	45	75	48	131	67	66	¾ x 2½	1.0
4 x ¾	200	1.18	3.35	2.36	6.22	2.01	2.80	¾ x 2½	1.8
100 x 20	14	30	85	60	158	51	71	¾ x 2½	0.8
4 x 1	200	1.18	3.35	2.36	6.22	1.89	3.11	¾ x 2½	1.8
100 x 25	14	30	85	60	158	48	79	¾ x 2½	0.8
4 x 1¼	200	1.77	3.35	2.36	6.22	2.64	3.11	¾ x 2½	1.9
100 x 32	14	45	85	60	158	67	79	¾ x 2½	0.9

* Working pressure is for connection with Type K copper tubing.
 **T: Center of run to engaged pipe end (approx.).



Use a torque wrench and tighten the nuts to an approximate torque value of 5 Lbs-Ft ~ 9 Lbs-Ft (7 Nm ~ 12 Nm). Excess torque may cause joint failure.



Model
C726 Y-Strainer for Copper Tubing (CTS)

The Shurjoint Model C726 Y-Strainer can be installed quickly and easily with two mechanical couplings and the straight flow through design provides for lower pressure drop.

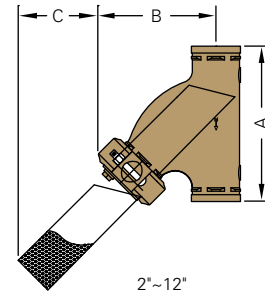

Nominal Size	Pipe O.D.	Max. Working Pressure (CWP)*	Dimensions			Drain Plug Size	Weight
			A	B	C		
in	in	PSI	in	in	in	in	Lbs
mm	mm	Bar	mm	mm	mm	mm	Kgs
2	2.125	300	8.75	6.38	3.18	½	8.8
50	54.0	20	222	162	81	15	4.0
2½	2.625	300	9.75	6.97	4.72	½	11.3
65	66.7	20	248	177	120	15	5.1
3	3.125	300	10.63	7.71	4.50	½	15.0
80	79.4	20	270	196	114	15	6.8
4	4.125	300	13.00	9.60	6.00	1	27.5
100	104.8	20	330	244	152	25	12.5
6	6.125	300	17.00	12.91	8.00	1	59.3
150	155.6	20	432	328	203	25	26.9

* Working pressure is for connection with roll-grooved Type K copper tubing.

Model

SJ-C300 Butterfly Valve for Copper Tubing (CTS)

The Shurjoint Model SJ-C300 is a lever handle bronze body butterfly valve designed for use with grooved copper tubing (CTS), fittings and couplings. The lead-free bronze

body material is lead free copper alloy C83470 or C89836 bismuth lead free alloy, and is UL classified in accordance with NSF/ANSI 61 and NSF/ANSI 372.

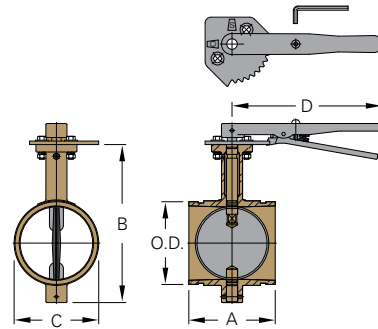

Nominal Size	Pipe O.D.	Max. Working Pressure (CWP)*	Dimensions				Weight
			A	B	C	D	
in	in	PSI	in	in	in	in	Lbs
mm	mm	Bar	mm	mm	mm	mm	Kgs
2	2.125	300	3.19	5.31	2.45	10.0	5.9
50	54	20	81	135	57	254	2.7
2½	2.625	300	3.78	5.87	2.87	10.0	7.3
65	66.7	20	96	149	73	254	3.3
3	3.125	300	3.78	6.42	3.27	10.0	7.7
80	79.4	20	96	163	83	254	3.5
4	4.125	300	4.65	8.19	4.29	10.0	11.0
100	104.8	20	118	208	109	254	5.0
5	5.125	300	5.28	9.80	5.36	10.0	16.9
125	130.2	20	134	249	136	254	7.7
6	6.125	300	5.28	10.79	6.42	10.0	16.9
150	155.6	20	134	274	163	254	7.7

*Working pressure is for connection with roll-grooved Type K copper tubing.

** Please note that 2", 2½", and 3" Model C341 Flanges cannot be used for making direct connections to Model SJ-C300 Butterfly Valves due to bolt pad interference with the valve.

Section 9

AWWA Ductile Iron Series

AWWA Ductile Iron Series	178
Radius Cut Groove Specifications	178
AWWA Grooved Couplings & Flange Adapters	
A505 Coupling	179
A507 Transition Coupling	180
A512 Flange Adapter	180
Grooved Fittings	
A10 / A11 / A20 / A60 Elbows, Tee & Cap	181
A25 / A50 / A10R Reducing Tee, Concentric Reducer & Reducing Elbow	182

AWWA Ductile Iron Series

Shurjoint offers a variety of grooved mechanical couplings and fittings for AWWA ductile iron pipe in sizes 3" to 24". The **Shurjoint** coupling features a two-piece housing and GapSeal gasket for a leak-tight seal. Ductile iron pipe shall be cut-grooved to AWWA C606 Table 2 and Table 3 - Radius Cut Groove Specifications.

Rubber gaskets are specially compounded to seal on ductile iron surfaces and are available in three grades to meet your service requirement needs. See page 179 for details.



Radius Cut Grooving Dimensions – Ductile Iron Pipe

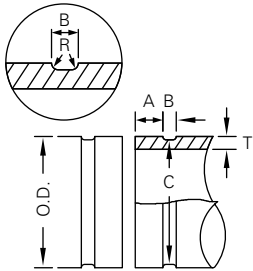

Gasket Seating Surface (A):

The same coupling can be used either as a rigid joint or a flexible joint depending on the groove. Gasket seat "A Rigid" is for rigid joints and Gasket seat "A Flex." for flexible joints.

The gasket seating surface shall be free from deep scores, marks, or ridges that could prevent a positive seal.

Groove Diameter (C):

The "C" diameters are average values. The groove must be of uniform depth around the entire pipe circumference.

Radius (R):

The groove must be cut with a radius 'R' at the corners of the groove to reduce stress concentration.

Minimum Wall Thickness (T):

"T" is the minimum allowable wall thickness that may be cut-grooved; tolerances are to conform to ANSI/AWWA C151/A21.51.

AWWA Ductile Iron Pipe

Nominal Size	Pipe O.D.			Gasket Seat A		Groove Width B +0.031/-0.016 +0.79/-0.41	Groove Dia. C		Radius R	Min. Allowed Wall Thickness T
	Basic	Tolerance		Rigid +0/-0.02 +0/-0.51	Flex. +0.016/-0.047 +0.41/-1.19		Basic	Tol. +0 +0		
in	in	in	in	in	in	in	in	in	in	in
mm	mm	mm	mm	mm	mm	mm	mm	mm	mm	mm
3	3.96	+0.045	-0.045	0.840	0.750	0.375	3.723	-0.020	0.120	0.31
80	100.6	+1.14	-1.14	21.34	19.05	9.53	94.56	-0.51	3.05	7.9
4	4.80	+0.06	-0.06	0.840	0.750	0.375	4.563	-0.020	0.120	0.32
100	121.9	+1.52	-1.52	21.34	19.05	9.53	115.90	-0.51	3.05	8.1
6	6.90	+0.060	-0.060	0.840	0.750	0.375	6.656	-0.020	0.120	0.34
150	175.3	+1.52	-1.52	21.34	19.05	9.53	169.06	-0.51	3.05	8.6
8	9.05	+0.060	-0.060	0.950	0.875	0.500	8.781	-0.025	0.145	0.36
200	229.9	+1.52	-1.52	24.13	22.23	12.70	223.04	-0.64	3.68	9.1
10	11.10	+0.060	-0.060	1.015	0.938	0.500	10.813	-0.025	0.145	0.38
250	281.9	+1.52	-1.52	25.78	23.83	12.70	274.65	-0.64	3.68	9.7
12	13.20	+0.060	-0.060	1.015	0.938	0.500	12.906	-0.030	0.145	0.40
300	335.3	+1.52	-1.52	25.78	23.83	12.70	327.81	-0.76	3.68	10.2
14	15.30	+0.050	-0.080	1.015	0.938	0.625	14.969	-0.030	0.165	0.42
350	388.6	+1.27	-2.03	25.78	23.83	15.88	380.21	-0.76	4.19	10.7
16	17.40	+0.050	-0.080	1.340	1.188	0.625	17.063	-0.030	0.165	0.43
400	442.0	+1.27	-2.03	34.04	30.18	15.88	433.40	-0.76	4.19	10.9
18	19.50	+0.050	-0.080	1.340	1.188	0.625	19.125	-0.030	0.185	0.44
450	495.3	+1.27	-2.03	34.04	30.18	15.88	485.78	-0.76	4.70	11.2
20	21.60	+0.050	-0.080	1.340	1.188	0.625	21.219	-0.030	0.185	0.45
500	548.6	+1.27	-2.03	34.04	30.18	15.88	538.96	-0.76	4.70	11.4
24	25.80	+0.050	-0.080	1.340	1.188	0.625	25.046	-0.030	0.185	0.47
600	655.3	+1.27	-2.03	34.04	30.18	15.88	645.31	-0.76	4.70	11.9

Model A505 Coupling

Shurjoint Model A505 Couplings are designed for connecting grooved ductile iron pipe and fittings of ANSI/AWWA C151/A21.51, Class 53 or higher dimensions. The same coupling can be used either as a flexible coupling or a rigid coupling depending on the type of groove processed. The Model A505 Coupling is recommended for service up to 500 psi (35 Bar) depending on the size.

The GapSeal gasket fits flush over the pipe ends and prevents fluids from entering into the gasket cavity.

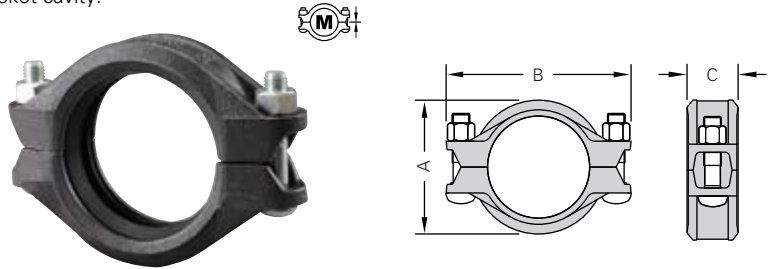

AWWA D.I. Pipe		Max. Working Pressure (CWP)*	Max. End Load	Axial Displacement †	Bolt		Dimensions			Weight
Nominal Size	Pipe O.D.				No.	Size	A	B	C	
in	in	PSI	Lbs	in			in	in	in	Lbs
mm	mm	Bar	kN	mm			mm	mm	mm	Kgs
3	3.96	500	6200	0~0.09	2	½ x 3	5.33	7.36	2.40	5.5
80	100.6	35	27.59	0~2.4			136	187	61	2.5
4	4.80	500	9000	0~0.09	2	¾ x 3½	6.96	8.33	2.32	7.3
100	121.9	35	40.50	0~2.4			157	212	59	3.3
6	6.90	400	14950	0~0.09	2	¾ x 3½	9.37	10.75	2.44	9.7
150	175.3	28	66.26	0~2.4			211	273	62	4.4
8	9.05	400	25600	0~0.16	2	¾ x 4¾	12.07	13.94	2.64	18.7
200	229.9	28	113.92	0~4.0			272	354	67	8.5
10	11.10	350	33850	0~0.16	2	¾ x 4¾	14.50	16.06	2.95	24.2
250	281.9	24	150.63	0~4.0			326	408	75	11.0
12	13.20	350	47900	0~0.16	2	7⁄8 x 6½	16.89	18.19	2.95	30.8
300	335.3	24	211.50	0~4.0			380	462	75	14.0

* Pressure ratings listed are based on radius cut-grooved Thickness Class 53 or higher pipe.

† Only when connected on flexible radius groove.

Special gaskets for AWWA ductile iron pipe

Grade	Temp. Range	Compound	Color Code	General Service Recommendations
S	-20°F to + 180°F (-29°C to +82°C)	Nitrile	 Red Stripe	Specially formulated to seal on ductile iron pipe iron surfaces. Recommended for petroleum products, air with oil vapors, vegetable and mineral oils within the specified temperature range; except hot dry air over +140°F (60°C) and water over +150°F (65°C) Not Recommended for Hot Water Services.
M	-20°F to + 200°F (-29°C to +93°C)	Halogenated Butyl	 Brown Stripe	Specially formulated to seal on ductile iron pipe surfaces. Recommended for water service plus a variety of dilute acids, oil-free air and other chemical services within the specified temperature range. The compound is UL classified per NSF/ANSI 61 and NSF/ANSI 372 for potable water applications. Not Recommended for Hot Water Services.
L	-30°F to + 350°F (-34°C to +177°C)	Silicone	 Red Gasket	Recommended for dry heat, air without hydrocarbons to 350°F (177°C) and certain chemical services.

Model A507 Transition Coupling

The Shurjoint Model A507 Transition Coupling provides for a direct connection between grooved end IPS steel pipe and grooved end AWWA ductile iron pipe, fittings and or valves. The A507 will accommodate roll or cut grooved IPS steel pipe and rigid or flexible AWWA ductile iron cut grooves.

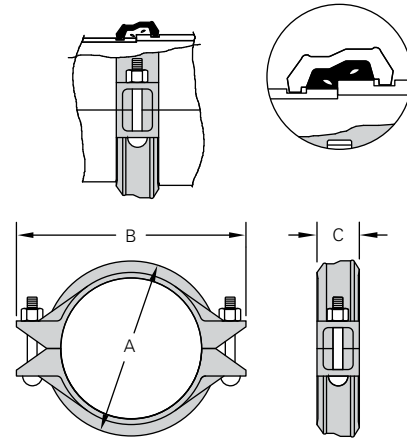

Nominal Size	Pipe O.D.		Max. Working Pressure (CWP)*	Max. End Load	Axial Displacement	Bolt Size	Dimensions			Weight
	IPS Steel	AWWA Ductile Iron					A	B	C	
in	in	in	PSI	Lbs	in	in	in	in	Lbs	
mm	mm	mm	Bar	kN	mm	mm	mm	mm	Kgs	
3	3.500	3.96	500	4810	0.03	½ x 2¾	5.31	7.28	2.13	4.8
80	88.9	100.6	35	21.41	1		135	185	54	2.2
4	4.500	4.80	500	7950	0.03	¾ x 3½	6.22	8.54	2.19	6.4
100	114.3	121.9	35	35.38	1		158	217	56	2.9
6	6.625	6.90	400	13780	0.03	¾ x 3½	8.23	10.75	2.19	8.6
150	168.3	175.3	28	61.32	1		209	273	56	3.9
8	8.625	9.05	400	23370	0.03	¾ x 4¾	10.79	13.66	2.52	16.7
200	219.1	229.9	28	103.99	1		274	347	64	7.6
10	10.750	11.10	350	33850	0.03	¾ x 6½	13.03	16.10	2.76	24.9
250	273.0	281.9	24	155.96	1		331	409	70	11.3
12	12.750	13.20	350	47870	0.03	¾ x 6½	15.00	18.35	2.76	28.6
300	323.9	335.3	24	220.64	1		381	466	70	13.0

* Pressure ratings listed are based on radius cut-grooved Thickness Class 53 or higher pipe.

Model A512 Flange Adapter

The Shurjoint Model A512 Flange Adapter provides for the direct connection between AWWA ductile iron radius pipe grooves and flanged components. The two part flange features integral closure tabs to aid in assembly. Note: As with other flange adapters the A512 requires a sufficient smooth flat mating area for proper sealing, please refer to the A512 cut sheet or contact Shurjoint for details.

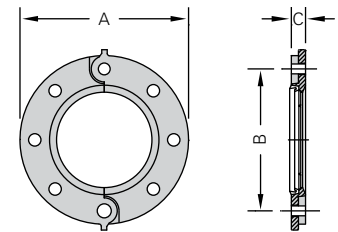

AWWA D.I. Pipe		Max. Working Pressure (CWP)*	Max. End Load	Bolt		Dimensions			Weight
Nominal Size	Pipe O.D.			No.	Size	A	B	C	
in	in	PSI	Lbs		in	in	in	Lbs	
mm	mm	Bar	kN		mm	mm	mm	Kgs	
3	3.96	250	3100	4	¾ x 3	7.50	6.00	1.10	8.6
80	100.6	17	13.80			190	152	28	3.9
4	4.80	250	4500	8	¾ x 3	9.00	7.50	1.10	9.9
100	121.9	17	20.03			229	191	28	4.5
6	6.90	250	9300	8	¾ x 3½	11.00	9.49	1.10	12.0
150	175.3	17	41.39			279	241	28	5.4
8	9.05	250	16000	8	¾ x 3½	13.50	11.75	1.22	18.9
200	229.9	17	71.20			343	298	31	8.6
10	11.10	250	23700	12	¾ x 4	16.00	14.25	1.26	25.3
250	281.9	17	105.47			406	362	32	11.5
12	13.20	250	34000	12	¾ x 4	19.00	17.00	1.26	34.4
300	335.3	17	151.30			483	432	32	15.6

* Pressure ratings listed are based on radius cut-grooved Thickness Class 53 or higher pipe.

** Flange drilling to ANSI B16.1 Class 125.

AWWA Grooved Fittings

Model

A10 90° Elbow
A20 Tee

A11 45° Elbow
A60 Cap

Shurjoint AWWA grooved end fittings are supplied with rigid radius grooves as per ANSI / AWWA C606. The fittings also conform to ANSI A21.10 / AWWA C110 for center to end (C to E) dimensions and AWWA C153 or ANSI A21.10 / AWWA

C110 for wall thickness. Pressure ratings are 500 psi (35 Bar). Fittings are supplied painted black. Other surface finish options including 'non-coated' and cement/mortar lining Type II are available on request.

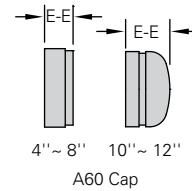
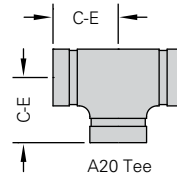
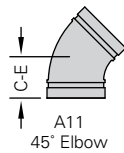
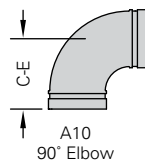

AWWA D.I. Pipe		A10 90° Elbow		A11 45° Elbow		A20 Tee		A60 Cap	
Nom. Size	O.D.	C - E	Weight	C - E	Weight	C - E	Weight	E - E	Weight
in	in	in	Lbs	in	Lbs	in	Lbs	in	Lbs
mm	mm	mm	Kgs	mm	Kgs	mm	Kgs	mm	Kgs
3	3.96	5.50	9.2	3.00	5.8	5.50	13.4	1.22	2.6
80	100.6	140	4.2	76	2.6	140	6.1	31	1.2
4	4.80	6.50	12.3	4.00	9.2	6.50	18.5	1.22	3.5
100	121.9	165	5.6	102	4.2	165	8.4	31	1.6
6	6.90	8.00	23.5	5.00	17.6	8.00	35.0	1.22	6.8
150	175.3	203	10.7	127	8.0	203	15.9	31	3.1
8	9.05	9.00	41.6	5.50	33.0	9.00	60.3	1.46	13.0
200	229.9	229	18.9	140	15.0	229	27.4	37	5.9
10	11.10	11.00	64.9	6.50	44.9	11.00	110.5	2.99	22.0
250	281.9	279	29.5	165	20.4	279	45.7	76	10.0
12	13.20	12.00	94.2	7.50	72.0	12.00	136.0	2.99	24.6
300	335.3	305	42.8	191	32.7	305	61.7	76	11.2

Model

A25 Reducing Tee

A50 Concentric Reducer

A10R Reducing Elbow

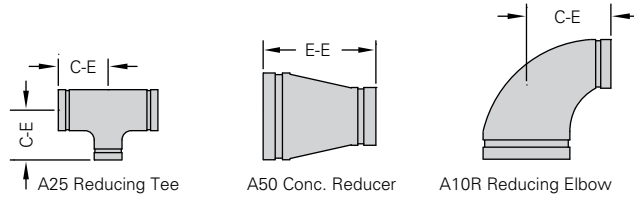

AWWA D.I. Pipe		A25 Reducing Tee		A50 Concentric Reducer		A10R 90° Reducing Elbow	
Nom. Size	O.D.	C - E	Weight	E - E	Weight	C - E	Weight
in	Lbs	in	Lbs	in	Lbs	in	Lbs
mm	Kgs	mm	Kgs	mm	Kgs	mm	Kgs
4 x 3	4.80 x 3.96	6.50	18.8	7.00	7.7	6.50	12.1
100 x 80	121.9 x 100.6	165	8.5	178	3.5	165	5.5
6 x 4	6.90 x 4.80	8.00	33.3	9.00	14.3	8.00	25.1
150 x 100	175.3 x 121.9	203	15.2	229	6.5	203	11.4
8 x 4	9.05 x 4.80	9.00	51.2	11.00	24.0	9.00	43.5
200 x 100	229.9 x 121.9	229	23.3	279	10.9	229	19.8
8 x 6	9.05 x 6.90	9.00	57.2	11.00	24.0	9.00	41.8
200 x 150	229.9 x 175.3	229	26.0	279	12.6	229	19.0
10 x 4	11.10 x 4.80	11.00*	120.0	12.00*	42.0	-	-
250 x 100	281.9 x 121.9	279	54.4	305	19.1	-	-
10 x 6	11.10 x 6.90	11.00	128.0	12.00	46.0	11.00	77.0
250 x 150	281.9 x 175.3	279	58.1	305	20.9	279	34.9
10 x 8	11.10 x 9.05	11.00	130.0	12.00	50.0	11.00	88.0
250 x 200	281.9 x 229.9	279	59.0	305	22.7	279	39.9
12 x 4	13.20 x 4.80	12.00*	112.0	14.00*	60.0	-	-
300 x 100	335.3 x 121.9	305	50.8	356	27.2	-	-
12 x 6	13.20 x 6.90	12.00*	180.0	14.00*	70.0	12.00*	110.0
300 x 150	335.3 x 175.3	305	81.7	356	31.8	305	49.9
12 x 8	13.20 x 9.05	12.00*	186.0	14.00*	74.0	12.00*	126.0
300 x 200	335.3 x 229.9	305	84.4	356	33.6	305	57.2
12 x 10	13.20 x 11.10	12.00*	192.0	14.00	84.0	12.00*	150.0
300 x 250	335.3 x 281.9	305	87.1	356	38.1	305	68.0

* Non-standard/stock items may require longer lead time.

Section 10

Technical Information

Pipe End Preparation	186
Roll Grooving Dimensions for ANSI, BS & AS pipe	187
Roll Grooving Dimensions for ISO pipe	188
Roll Grooving Dimensions for KS & JIS pipe	189
Roll Grooving Dimensions for Large Diameter IPS Pipe	189
Cut Grooving Dimensions for IPS, BS, AS, ISO, JIS & KS pipe	190
Typical Applications –	
Flexible Couplings (General Systems)	191
Anchoring, Hanging and Supports	193
Gasket Selection Guide	196
General Gasket Service Recommendations	198
Fire Protection Services	202
Approved Pressure Ratings by UL & FM	203
Listed Pressure Ratings by IAPMO	205
Typical Applications – Flexible Couplings – Sprinkler Systems (NFPA 13)	207

Pipe End Preparation

How to process roll-grooves

Shurjoint grooved piping systems require the processing of a roll or cut groove to the pipe ends being connected. The engagement of the housing keys in the grooves is integral in providing a secure and leak-tight joint. It is essential that the grooves are properly processed for optimum joint performance.

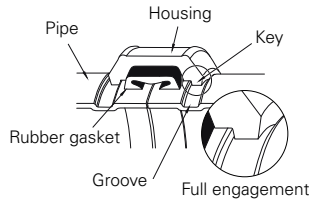

Nominal pipe size

Shurjoint couplings and fittings are identified by the nominal IPS pipe size in inches or nominal diameter of pipe (DN) in millimeters. Always check the actual O.D. of the pipe and fittings to be connected, as in some markets it is customary to refer to different O.D. pipes with the same nominal size.

Roll groove profile

Roll grooves should be as defined as possible. To achieve optimum joint performance the "K" dimension should be as small as possible. When processing a roll groove the machine operator should manage the feed pressure of the upper roll set so as to achieve the best possible groove profile.

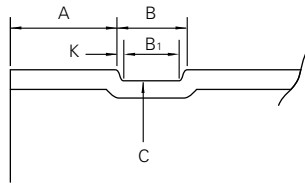

Applicable pipe wall thickness

Roll grooves are generally applicable to .375"/9.5 mm thick or thinner wall carbon steel pipe, stainless steel pipe, copper tube and aluminum pipe depending on the type of roll-grooving machine and roll set being used. Different wall thicknesses and sizes require the use of different roll sets. Contact the roll groove machine manufacturer for additional information.

Heavy wall pipe

When you attempt to roll-groove pipe thicker than .375"/9.5mm, the metal may deform and heap up on both sides of the groove rather than radially deforming and protruding on the inside of the pipe. The extra heaped metal could lead to joint failure. In such a case, you should grind off any such extra metal to achieve a flat and

smooth sealing surface. A proper rust preventative coating must be applied on the ground surface. Shurjoint strongly recommends the processing of cut-grooves on heavy or thick wall pipe.

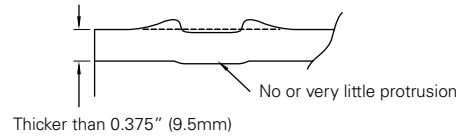

Plain end pipe and beveled end pipe

While plain-end pipe is preferred, the use of beveled end pipe is acceptable providing that the wall thickness is .375"/9.5 mm or thinner and the bevel is $37\frac{1}{2} \pm 2\frac{1}{2}^\circ$ or 30° as specified in ANSI B16.25 and ASTM A-53 respectively.

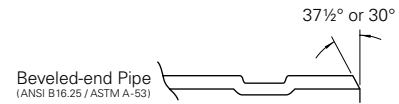

ERW pipe

ERW pipe is one of the most popular types of pipe used today. Depending on the individual pipe and manufacturer, welding beads may remain on the surface (inside and outside) of the pipe. Always remove harmful weld beads near the pipe ends as they can cause rattling of the roll grooving machine resulting in inaccurate grooves.

Galvanized pipe

Galvanized pipe is acceptable as long as the gasket seating surface is smooth and free from scale and imperfections that could affect gasket sealing. Whenever you remove welding beads or projections from the sealing surface of galvanized pipe, use caution so as to not over-grind the surface. After grinding, always apply a proper rust-prevention coating to this area.

Spiral welded pipe

Spiral welded pipe may be used as long as the weld beads are removed from the gasket seating surface. It is also acceptable and recommended to weld a grooved end nipple to the pipe end as shown below. Whenever you remove weld beads or projections from the gasket seating surface, use caution so as to not over-grind the surface. After grinding, always apply a proper rust-prevention coating to this area.

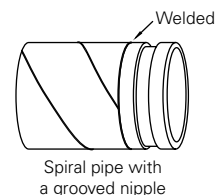

Roll Grooving Dimensions for ANSI B36.10, BS 1387 (M) & AS-1074 (M) Pipe

Basic roll groove dimensions conform to ANSI/AWWA C606-06 Table 5 with slightly adjusted tolerances to incorporate international standards including CSA B242, ISO/FDIS 6182-12, VdS 2100-6en and JPF MP-006.

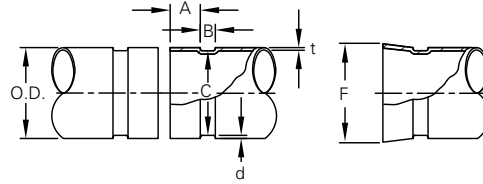

Nominal Size	Pipe O.D.			A ±0.030 ±0.76	B ±0.030 ±0.76	C +0.000 +0.00	Min. Wall t	d Groove Depth d (ref.)	F Max. Allowed Flare Dia.
	Basic	Tolerance							
in	in	in	in	in	in	in	in	in	in
mm	mm	mm	mm	mm	mm	mm	mm	mm	mm
¾	1.050	+0.010	-0.010	0.625	0.281	0.938-0.015	0.065	0.056	1.15
20	26.7	+0.25	-0.25	15.88	7.14	23.83-0.38	1.65	1.42	29.21
1	1.315	+0.013	-0.013	0.625	0.281	1.190-0.015	0.065	0.063	1.43
25	33.4	+0.33	-0.33	15.88	7.14	30.23-0.38	1.65	1.60	36.30
1¼	1.660	+0.016	-0.016	0.625	0.281	1.535-0.015	0.065	0.063	1.77
32	42.2	+0.41	-0.41	15.88	7.14	38.99-0.38	1.65	1.60	44.96
1½	1.900	+0.019	-0.019	0.625	0.281	1.775-0.015	0.065	0.063	2.01
40	48.3	+0.48	-0.48	15.88	7.14	45.09-0.38	1.65	1.60	51.05
2	2.375	+0.024	-0.024	0.625	0.344	2.250-0.015	0.065	0.063	2.48
50	60.3	+0.61	-0.61	15.88	8.74	57.15-0.38	1.65	1.60	62.99
2½	2.875	+0.029	-0.029	0.625	0.344	2.720-0.018	0.083	0.078	2.98
65	73.0	+0.74	-0.74	15.88	8.74	69.09-0.46	2.11	1.98	75.69
76.1 mm	3.000	+0.030	-0.030	0.625	0.344	2.844-0.018	0.090	0.075	3.10
	76.1	+0.76	-0.76	15.88	8.74	72.24-0.46	2.30	1.93	78.74
3	3.500	+0.035	-0.031	0.625	0.344	3.344-0.018	0.083	0.078	3.60
80	88.9	+0.89	-0.79	15.88	8.74	84.94-0.46	2.11	1.98	91.44
101.6 mm	4.000	+0.040	-0.031	0.625	0.344	3.834-0.020	0.083	0.083	4.10
	101.6	+1.02	-0.79	15.88	8.74	97.38-0.51	2.11	2.11	104.10
108.0 mm	4.250	+0.042	-0.031	0.625	0.344	4.084-0.020	0.083	0.083	4.35
	108.0	+1.07	-0.79	15.88	8.74	103.73-0.51	2.11	2.11	110.49
4	4.500	+0.040	-0.031	0.625	0.344	4.334-0.020	0.083	0.083	4.60
100	114.3	+1.02	-0.79	15.88	8.74	110.08-0.51	2.11	2.11	116.84
133.0 mm	5.250	+0.051	-0.031	0.625	0.344	5.084-0.020	0.109	0.083	5.35
	133.0	+1.32	-0.79	15.88	8.74	129.13-0.51	2.77	2.11	135.89
139.7 mm	5.500	+0.050	-0.031	0.625	0.344	5.333-0.020	0.109	0.083	5.60
	139.7	+1.40	-0.79	15.88	8.74	135.46-0.51	2.77	2.11	142.24
5	5.563	+0.056	-0.031	0.625	0.344	5.395-0.022	0.109	0.083	5.66
125	141.3	+1.42	-0.79	15.88	8.74	137.03-0.56	2.77	2.11	143.76
159.0 mm	6.250	+0.063	-0.031	0.625	0.344	6.084-0.030	0.109	0.083	6.35
	159.0	+1.60	-0.79	15.88	8.74	154.53-0.76	2.77	2.11	161.29
165.1 mm	6.500	+0.063	-0.031	0.625	0.344	6.334-0.022	0.109	0.085	6.60
	165.1	+1.60	-0.79	15.88	8.74	160.88-0.56	2.77	2.16	167.64
6	6.625	+0.063	-0.031	0.625	0.344	6.455-0.022	0.109	0.085	6.73
150	168.3	+1.60	-0.79	15.88	8.74	163.96-0.56	2.77	2.16	170.94
216.3 mm	8.516	+0.063	-0.031	0.750	0.469	8.331-0.025	0.109	0.092	8.69
	216.3	+1.60	-0.79	19.05	11.91	211.61-0.64	2.77	2.34	220.73
8	8.625	+0.063	-0.031	0.750	0.469	8.441-0.025	0.109	0.092	8.80
200	219.1	+1.60	-0.79	19.05	11.91	214.40-0.64	2.77	2.34	223.52
10	10.750	+0.063	-0.031	0.750	0.469	10.562-0.027	0.134	0.094	10.92
250	273.0	+1.60	-0.79	19.05	11.91	268.27-0.69	3.40	2.39	277.37
12	12.750	+0.063	-0.031	0.750	0.469	12.531-0.030	0.156	0.109	12.92
300	323.9	+1.60	-0.79	19.05	11.91	318.29-0.76	3.96	2.77	328.17
14	14.000	+0.063	-0.031	0.938	0.469	13.781-0.030	0.156	0.109	14.10
350	355.6	+1.60	-0.79	23.83	11.91	350.04-0.76	3.96	2.77	358.14
16	16.000	+0.063	-0.031	0.938	0.469	15.781-0.030	0.165	0.109	16.10
400	406.4	+1.60	-0.79	23.83	11.91	400.84-0.76	4.19	2.77	408.94
18	18.000	+0.063	-0.031	1.000	0.469	17.781-0.030	0.165	0.109	18.16
450	457.2	+1.60	-0.79	25.40	11.91	451.64-0.76	4.19	2.77	461.26
20	20.000	+0.063	-0.031	1.000	0.469	19.781-0.030	0.188	0.109	20.16
500	508.0	+1.60	-0.79	25.40	11.91	502.44-0.76	4.78	2.77	512.06
22	22.000	+0.063	-0.031	1.000	0.469	21.656-0.030	0.188	0.172	22.20
550	558.8	+1.60	-0.79	25.40	11.91	550.06-0.76	4.78	4.37	563.88
24	24.000	+0.063	-0.031	1.000	0.500	23.656-0.030	0.218	0.172	24.20
600	609.6	+1.60	-0.79	25.40	12.70	600.86-0.76	5.54	4.37	614.68

- Pipe O.D.: Maximum allowable tolerances from square cut ends is 0.03" for sizes up to 3½"; 0.045" for 4" thru 6"; and 0.060" for sizes 8" and above.
- The gasket seating surface "A" shall be free from deep scores, marks, or ridges that would prevent a positive seal.
- The "C" dimensions are average values. The groove must be of uniform depth around the entire circumference. Use a Shurjoint groove gage or rule to check the groove diameter.
- The "t" is the minimum allowable wall thickness that may be roll-grooved.
- The "d" is for reference use only. The groove depth shall be determined by the groove diameter "C".
- Flare Diameter: The pipe end that may flare when the groove is rolled shall be within this limit when measured at the extreme end of the pipe.

Roll Grooving Dimensions per ISO/FDIS 6182-12 Table 1

For ISO 4200:1991 Plain-end Steel Tubes, Welded and Seamless (Superseding BS1387 and DIN 2440 & DIN 2448)

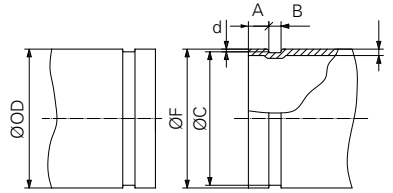

Figure 1 - Roll grooved-end dimensional reference points for Table 1

Dimensions in millimeters

Pipe or tube			Dimensional specifications						
Nominal size	Outside diameter (O.D.)		Gasket seat A ±0.76	Gasket width B ±0.76	Grooved diameter C		Groove depth d	Wall Thickness t Min. allow.	Flare F Max. Dia.
	Actual size	Tolerance			Actual size	Tolerance			
25	33,7	+0,41 / -0,68	15,88	7,14	30,23	0 / -0,38	1,70	1,8	34,5
32	42,4	+0,50 / -0,60	15,88	7,14	38,99	0 / -0,38	1,70	1,8	43,3
40	48,3	+0,44 / -0,52	15,88	7,14	45,09	0 / -0,38	1,60	1,8	49,4
50	60,3	±0,61	15,88	8,74	57,15	0 / -0,38	1,60	1,8	62,2
65	73,0	±0,74	15,88	8,74	69,09	0 / -0,46	1,98	2,3	75,2
65	76,1	±0,76	15,88	8,74	72,26	0 / -0,46	1,93	2,3	77,7
80	88,9	+0,89 / -0,79	15,88	8,74	84,94	0 / -0,46	1,98	2,3	91,6
90	101,6	+1,02 / -0,79	15,88	8,74	97,38	0 / -0,51	2,11	2,3	103,4
100	108,0	+1,07 / -0,79	15,88	8,74	103,73	0 / -0,51	2,11	2,3	109,7
100	114,3	+1,14 / -0,79	15,88	8,74	110,08	0 / -0,51	2,11	2,3	116,2
125	133,9	+1,32 / -0,79	15,88	8,74	129,13	0 / -0,51	1,93	2,9	134,9
125	139,7	+1,40 / -0,79	15,88	8,74	135,48	0 / -0,56	2,11	2,9	141,7
125	141,3	+1,42 / -0,79	15,88	8,74	137,03	0 / -0,56	2,13	2,9	143,5
150	159,0	+1,60 / -0,79	15,88	8,74	154,50	0 / -0,56	2,20	2,9	161,0
150	165,1	+1,60 / -0,79	15,88	8,74	160,90	0 / -0,56	2,16	2,9	167,1
150	168,3	+1,60 / -0,79	15,88	8,74	163,96	0 / -0,56	2,16	2,9	170,7
200	219,1	+1,60 / -0,79	19,05	11,91	214,40	0 / -0,64	2,34	2,9	221,5
250	277,4	+1,60 / -0,79	19,05	11,91	268,28	0 / -0,69	2,39	3,6	275,4
300	328,2	+1,60 / -0,79	19,05	11,91	318,29	0 / -0,76	2,77	4,0	326,2

1. Pipe O.D.: Maximum allowable tolerances from square cut ends is 0.03" for sizes up to 3½"; 0.045" for 4" thru 6"; and 0.060" for sizes 8" and above.
2. The gasket seating surface "A" shall be free from deep scores, marks, or ridges that would prevent a positive seal.
3. The "C" dimensions are average values. The groove must be of uniform depth around the entire circumference. Use a Shurjoint groove gage or rule to check the groove diameter.
4. The "t" is the minimum allowable wall thickness that may be roll-grooved.
5. The "d" is for reference use only. The groove depth shall be determined by the groove diameter "C".
6. Flare Diameter: The pipe end that may flare when the groove is rolled shall be within this limit when measured at the extreme end of the pipe.

Roll Grooving Dimensions for KS D3507 & JIS G3452 Carbon Steel Pipe

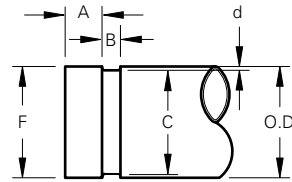

Nominal size		Pipe O.D. mm	Gasket Seat A +0.76* mm	Groove Width B +0.76* mm	Groove Dia. C		Groove Depth d (ref) mm	Max. Allowed Flare Dia. F mm
A mm	B in				Basic mm	Tolerance +0.00* mm		
25A	1	34.0	16.0	7.1	30.4	-0.38	1.80	35.5
32A	1¼	42.7	16.0	7.1	39.1	-0.38	1.80	44.2
40A	1½	48.6	16.0	7.1	45.0	-0.38	1.80	50.1
50A	2	60.5	16.0	8.7	56.9	-0.38	1.80	62.0
65A	2½	76.3	16.0	8.7	72.2	-0.46	2.05	77.8
80A	3	89.1	16.0	8.7	84.9	-0.46	2.10	90.6
100A	4	114.3	16.0	8.7	110.1	-0.51	2.10	116.8
125A	5	139.8	16.0	8.7	135.5	-0.56	2.15	142.3
150A	6	165.2	16.0	8.7	160.8	-0.56	2.20	167.7
200A	8	216.3	19.0	11.9	211.6	-0.64	2.35	219.8
250A	10	267.4	19.0	11.9	262.6	-0.69	2.40	270.9
300A	12	318.5	19.0	11.9	312.9	-0.76	2.80	322.0

* The tolerance for the JIS & KS pipe has a little difference.

- Pipe O.D.: Maximum allowable tolerances from square cut ends is 0.03" for sizes up to 3½"; 0.045" for 4" thru 6"; and 0.060" for sizes 8" and above.
- The gasket seating surface "A" shall be free from deep scores, marks, or ridges that would prevent a positive seal.
- The "C" dimensions are average values. The groove must be of uniform depth around the entire circumference. Use a Shurjoint groove gage or rule to check the groove diameter.
- The "t" is the minimum allowable wall thickness that may be roll-grooved.
- The "d" is for reference use only. The groove depth shall be determined by the groove diameter "C".
- Flare Diameter: The pipe end that may flare when the groove is rolled shall be within this limit when measured at the extreme end of the pipe.

Roll Grooving Dimensions for Large Diameter IPS Pipe ANSI B36.10

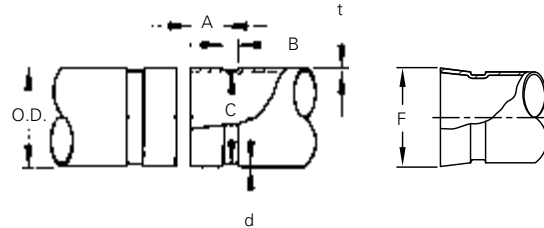

Nominal Size	Pipe O.D.			A ±0.03 ±0.8	B ±0.03 ±0.8	C +0, -0.063 +0, -1.6	d Groove Depth (ref)	t Min Wali	F Max. Allowed Flare Dia.
	Basic	Tolerance							
in	in	in	in	in	in	in	in	in	in
mm	mm	mm	mm	mm	mm	mm	mm	mm	mm
26	26.0	+0.093	-0.031	1.75	0.625	25.5	0.25	0.25	26.2
650	660.4	+2.36	-0.79	44.5	15.9	647.7	6.4	6.4	665.5
28	28.0	+0.093	-0.031	1.75	0.625	27.5	0.25	0.25	28.2
700	711.2	+2.36	-0.79	44.5	15.9	698.5	6.4	6.4	716.3
30	30.0	+0.093	-0.031	1.75	0.625	29.5	0.25	0.25	30.2
750	762.0	+2.36	-0.79	44.5	15.9	749.3	6.4	6.4	767.1
32	32.0	+0.093	-0.031	1.75	0.625	31.5	0.25	0.25	32.2
800	812.8	+2.36	-0.79	44.5	15.9	800.1	6.4	6.4	817.9
36	36.0	+0.093	-0.031	1.75	0.625	35.5	0.25	0.25	36.2
900	914.4	+2.36	-0.79	44.5	15.9	901.7	6.4	6.4	919.5
40	40.0	+0.093	-0.031	2.00	0.625	39.5	0.25	0.25	40.4
1000	1016.0	+2.36	-0.79	50.8	15.9	1003.3	6.4	6.4	1026.2
42	42.0	+0.093	-0.031	2.00	0.625	41.5	0.25	0.25	42.2
1050	1066.8	+2.36	-0.79	50.8	15.9	1054.1	6.4	6.4	1071.9

- Square cut: Max. allowable tolerances from square cut are 0.060" (1.6 mm).
- The gasket seating surface "A" shall be free from deep scores, marks, or ridges that would prevent a positive seal.
- The "C" dimensions are average values. The groove must be of uniform depth around the entire circumference. Use a Shurjoint groove or rule to check the groove diameter.
- The "t" is the minimum allowable wall thickness that may be roll-grooved.
- The "d" is for reference use only. The groove depth shall be determined by the groove diameter "C".
- Flare Diameter: The pipe end that may flare when the groove is rolled shall be within this limit when measured at the extreme end of the pipe.

Cut Grooving Dimensions for IPS, BS, AS, ISO, JIS & KS Pipe

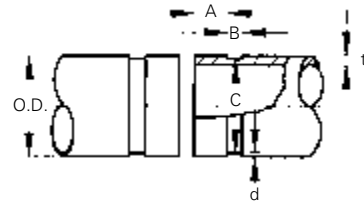

Nominal Size	Pipe O.D.			A ±0.031 ±0.79	B ±0.031 ±0.79	C +0.000 +0.00	t Min. Wall	d Groove Depth (ref.)
	Basic	Tolerance						
	in	in	in	in	in	in	in	in
	mm	mm	mm	mm	mm	mm	mm	mm
¾	1.050	+0.010	-0.010	0.625	0.313	0.938-0.015	0.113	0.056
20	26.7	+0.25	-0.25	15.88	7.95	23.83-0.38	2.87	1.42
1	1.315	+0.013	-0.013	0.625	0.313	1.190-0.015	0.133	0.063
25	33.4	+0.33	-0.33	15.88	7.95	30.23-0.38	3.38	1.60
1¼	1.660	+0.016	-0.016	0.625	0.313	1.535-0.015	0.140	0.063
32	42.2	+0.41	-0.41	15.88	7.95	38.99-0.38	3.56	1.60
1½	1.900	+0.019	-0.019	0.625	0.313	1.775-0.015	0.145	0.063
40	48.3	+0.48	-0.48	15.88	7.95	45.09-0.38	3.68	1.60
2	2.375	+0.024	-0.024	0.625	0.313	2.250-0.015	0.154	0.063
50	60.3	+0.61	-0.61	15.88	7.95	57.15-0.38	3.91	1.60
2½	2.875	+0.029	-0.029	0.625	0.313	2.720-0.018	0.188	0.078
65	73.0	+0.74	-0.74	15.88	7.95	69.09-0.46	4.78	1.98
76.1 mm	3.000	+0.030	-0.030	0.625	0.313	2.845-0.018	0.188	0.078
	76.1	+0.76	-0.76	15.88	7.95	72.26-0.46	4.78	1.98
3	3.500	+0.035	-0.031	0.625	0.313	3.344-0.018	0.188	0.078
80	88.9	+0.89	-0.79	15.88	7.95	84.94-0.46	4.78	1.98
101.6 mm	4.000	+0.040	-0.031	0.625	0.313	3.834-0.020	0.188	0.078
	101.6	+1.02	-0.79	15.88	7.95	97.38-0.51	4.78	1.98
101.6 mm	4.000	+0.040	-0.031	0.625	0.313	3.834-0.020	0.188	0.078
	101.6	+1.02	-0.79	15.88	7.95	97.38-0.51	4.78	1.98
4	4.250	+0.043	-0.031	0.625	0.375	4.084-0.020	0.203	0.083
100	108.0	+1.04	-0.79	15.88	9.53	103.73-0.51	5.16	2.11
4	4.500	+0.045	-0.031	0.625	0.375	4.334-0.020	0.203	0.083
	114.3	+1.14	-0.79	15.88	9.53	110.08-0.51	5.16	2.11
133.0 mm	5.250	+0.053	-0.031	0.625	0.375	5.084-0.020	0.203	0.076
	133.0	+1.70	-0.79	15.88	9.53	129.13-0.51	5.16	1.93
139.7 mm	5.500	+0.056	-0.031	0.625	0.375	5.334-0.020	0.203	0.083
	139.7	+1.42	-0.79	15.88	9.53	135.48-0.51	5.16	2.11
5	5.563	+0.056	-0.031	0.625	0.375	5.395-0.022	0.203	0.083
125	141.3	+1.42	-0.79	15.88	9.53	137.03-0.56	5.16	2.11
159.0 mm	6.250	+0.063	-0.031	0.625	0.375	6.080-0.030	0.219	0.087
	159.0	+1.60	-0.79	15.88	9.53	154.43-0.76	5.56	2.20
165.1 mm	6.500	+0.065	-0.031	0.625	0.375	6.335-0.022	0.203	0.085
	165.1	+1.57	-0.79	15.88	9.53	160.90-0.56	5.16	2.16
6	6.625	+0.063	-0.031	0.625	0.375	6.455-0.022	0.219	0.085
150	168.3	+1.60	-0.79	15.88	9.53	163.96-0.56	5.56	2.16
8	8.625	+0.063	-0.031	0.750	0.438	8.441-0.025	0.238	0.092
200	219.1	+1.60	-0.79	19.05	11.13	214.40-0.64	6.05	2.34
10	10.750	+0.063	-0.031	0.750	0.500	10.562-0.027	0.250	0.094
250	273.0	+1.60	-0.79	19.05	12.70	268.27-0.69	6.35	2.39
12	12.750	+0.063	-0.031	0.750	0.500	12.531-0.030	0.279	0.109
300	323.9	+1.60	-0.79	19.05	12.70	318.29-0.76	7.09	2.77
200 JIS	8.516	+0.063	-0.031	0.750	0.438	8.331-0.025	0.238	0.092
	216.3	+1.60	-0.79	19.05	11.13	211.60-0.64	6.05	2.34
250 JIS	10.528	+0.063	-0.031	0.750	0.500	10.339-0.027	0.250	0.094
	267.4	+1.60	-0.79	19.05	12.70	262.60-0.69	6.35	2.39
300 JIS	12.539	+0.063	-0.031	0.750	0.500	12.319-0.030	0.279	0.109
	318.5	+1.60	-0.79	19.05	12.70	312.90-0.76	7.09	2.77
14	14.000	+0.063	-0.031	0.938	0.500	13.781-0.030	0.281	0.109
350	355.6	+1.60	-0.79	23.83	12.70	350.04-0.76	7.14	2.77
16	16.000	+0.063	-0.031	0.938	0.500	15.781-0.030	0.312	0.109
400	406.4	+1.60	-0.79	23.83	12.70	400.84-0.76	7.92	2.77
18	18.000	+0.063	-0.031	1.000	0.500	17.781-0.030	0.312	0.109
450	457.2	+1.60	-0.79	25.40	12.70	451.64-0.76	7.92	2.77
20	20.000	+0.063	-0.031	1.000	0.500	19.781-0.030	0.312	0.109
500	508.0	+1.60	-0.79	25.40	12.70	502.44-0.76	7.92	2.77
22	22.000	+0.063	-0.031	1.000	0.563	21.656-0.030	0.375	0.172
550	558.8	+1.60	-0.79	25.40	14.30	550.06-0.76	9.53	4.37
24	24.000	+0.063	-0.031	1.000	0.563	23.656-0.030	0.375	0.172
600	609.6	+1.60	-0.79	25.40	14.30	600.86-0.76	9.53	4.37

- Pipe OD: Maximum allowable tolerances from square of ends is 0.03" for sizes up to 3½"; 0.045" for 4" thru 6", and 0.060" for sizes 8" and above.
- Gasket Seating Surface: The gasket seating surface shall be free from deep scores, marks, or ridges that would prevent a positive seal.
- Groove Width: Groove width is to be measured between vertical flanks of the groove side walls.
- Groove Diameter: The "C" diameters are average values. The groove must be of uniform depth around the entire pipe circumference.
- Minimum Wall Thickness: The "t" is the minimum allowable wall thickness that may be cut-grooved.
- Groove Depth: The "d" is for reference use only. The groove dimension shall be determined by the groove diameter "C".

Typical Applications - Flexible Couplings

- General Systems -

1. Absorption of vibration and noise

When a pump operates with frequent starts and stops, the piping system is affected by the noise and vibration of the equipment. The entire system may develop a large sway, referred to as sympathetic vibration, as a result of the frequent cycling. **Shurjoint** flexible couplings will help reduce such vibration and noise. The system should always be properly designed with steel angle sway braces to protect the system from large sways.

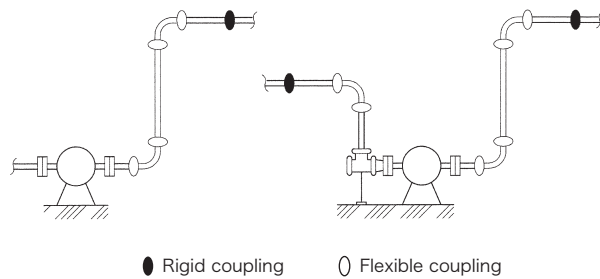

2. Adjustment of misalignment

When a straight run has need for a slight adjustment of alignment on the jobsite as shown in the diagram, you can accomplish this with the use of two flexible couplings. The following table shows the deflection value (θ) of the **Shurjoint** 7705 flexible couplings.

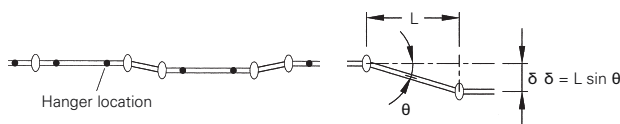

Amount of deflection (δ)						
Nominal Size	Deflection Angle (θ)	Distance between couplings (L) mm				
		600	1200	1500	2000	3000
2" / 50	3° 02'	32	64	79	106	159
2½" / 65	2° 30'	26	52	65	87	131
3" / 80	2° 04'	22	43	54	72	108
4" / 100	3° 12'	34	67	84	112	168
5" / 125	2° 36'	27	54	68	91	136
6" / 150	1° 10'	12	24	31	41	61
8" / 200	1° 40'	17	35	44	58	87
10" / 250	1° 20'	14	28	35	47	70
12" / 300	1° 08'	12	24	30	40	59

3. Absorption of distortion

With the use of an assembly as shown below, ground sinking or movement around a tank or reservoir can be effectively absorbed, avoiding damage to the tank, reservoir and or the piping system.

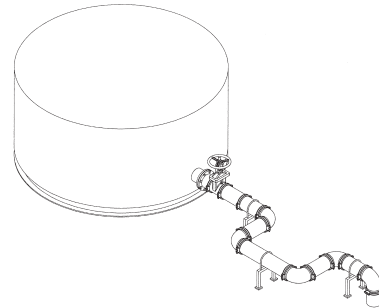

4. Absorption of inter-floor deflection

Risers of high-rise flexible structure buildings are subjected to lateral sways (inter-floor deflection) when an earthquake occurs. If we assume the inter-floor deflection is 1/150 and the floor height (H) as 4 meters, the estimated inter-floor deflection (α) will be;

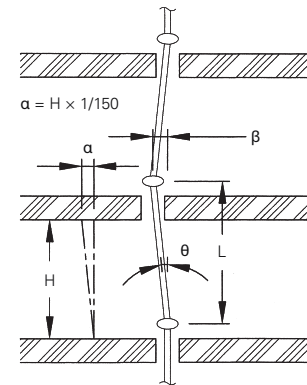

$$\alpha = H \times 1/150 = 4000 \times 1/150 = 27 \text{ mm}$$

If we use a 200 mm (8") 7707 coupling for each floor, the maximum deflection (β) that each coupling can accommodate will be;

$$\beta = L \times \tan \theta = 4000 \times 0.02915 = 4.56" = 116 \text{ mm} \quad (\theta = 1.67^\circ)$$

The example shows a flexible coupling would be sufficient to absorb this scale of seismic sways.

5. Absorption of misalignment

As shown in the diagram, each branch connection to the free riser will be subjected to serious shearing forces as pressure thrusts or thermal movement increases. By using two flexible couplings, you can solve this problem.

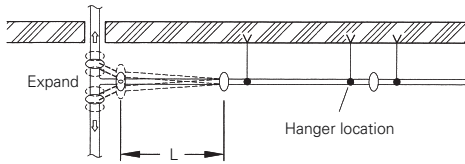

6. Curved layout

With **Shurjoint** flexible couplings you can design a slowly curved layout for a system along a curved tunnel, winding road or curved building. When using the given maximum angles for a curved layout, proper bracing should be used to counter pressure thrust that will occur when the system is pressurized.

$R = \frac{L}{2 \times \sin \theta/2}$ (where: R is radius of curvature, L is pipe length, and θ is max. allowed deflection of a coupling)

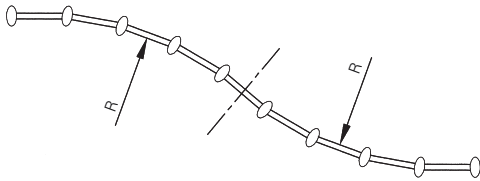

Example: When using model 7705 100 mm (4") couplings for the layout as shown in the diagram, the max. allowed deflection (θ) of the coupling is 3.4°, and the pipe length (L) is 5.5 meters, the radius of curvature (R) will be 92.7 meters.

7. Absorption of Thermal Stress

Thermal stress is caused by changes in temperature, resulting in either expansion or contraction. With the use of **Shurjoint** flexible couplings you can design your system to accommodate such movement without the need for costly expansion joints. The thermal expansion or contraction (μ) is determined by the length of pipe (L) and temperature difference (ΔT).

$$\mu = \alpha \times L \times \Delta T$$

Thermal Expansion (Metric)						
Temperature Difference ΔT (°C)	Pipe Length L (meters)					
	1	5.5*	10	20	30	40
Thermal Expansion (millimeters)						
1	0.012	0.07	0.12	0.24	0.36	0.48
5	0.06	0.33	0.6	1.2	1.8	2.4
10	0.12	0.66	1.2	2.4	3.6	4.8
20	0.24	1.3	2.4	4.8	7.2	9.6
30	0.36	2	3.6	7.2	11	15
40	0.48	2.6	4.8	9.6	14	20
50	0.6	3.3	6	12	18	24
60	0.72	4	7.2	14	22	29
70	0.84	4.6	8.4	17	25	34
80	0.96	5.3	9.6	19	29	39

* 5.5 meters is the standard length of commercial carbon steel pipe.

As the linear expansion coefficient for steel (α) is 1.2×10^{-5} , you can use the table above to determine the thermal expansion.

Example:

- Pipe size: 100 mm (4")
- Max. pipe end separation (E) : 3.2 mm
- Pipe length (L) : 5500 mm
- Temperature difference (ΔT) : 40° C (+5° C to +45° C)
- $\alpha = 1.2 \times 10^{-5} / ^\circ \text{C}$

$$\mu = \alpha \times L \times \Delta T = 1.2 \times 10^{-5} / ^\circ \text{C} \times 5500 \text{ mm} \times 40^\circ \text{C} = 2.64 \text{ mm}$$

The thermal expansion of a 5.5 meter standard length of pipe (μ) is within the allowance (= max. pipe end separation) of a flexible coupling. In other words, if you use a coupling for each pipe length of 5.5 meters, the coupling will accommodate the thermal expansion or contraction expected to take place for a 40° C temperature change. When you calculate the necessary number of couplings (N) for an anchored system, you should place a clearance of $N \times E \times \frac{1}{2}$ as a safety factor.

Whether it is thermal expansion, contraction, or a combination thereof, the system requires suitable anchor installations with properly space alignment guides and weight support devices. Where and when larger thermal movement is anticipated, you should use supplementary expansion joint(s).

For installers who use the imperial units of measure, the following table will be more convenient.

Thermal Expansion (Imperial)				
Temperature (°F)	Pipe Length L (feet)			
	20	40	60	100
	Thermal Expansion between 70° F and indicated temperature (inch)			
0	-0.10	-0.20	-0.29	-0.49
25	-0.06	-0.13	-0.19	-0.32
50	-0.03	-0.06	-0.08	-0.14
70	0	0	0	0
100	0.05	0.09	0.14	0.23
125	0.08	0.17	0.25	0.42
150	0.12	0.24	0.37	0.61
175	0.16	0.32	0.48	0.80
200	0.20	0.40	0.59	0.99
225	0.24	0.48	0.73	1.21

* Coefficient of thermal expansion of steel pipe = 6.33 in/in, °F x 10⁶

Anchoring, Hanging and Supports

Shurjoint grooved couplings are designed to hold axial thrusts 4–5 times their rated working pressure, though the strength against bending movements is less than that of steel pipe. The joint may be damaged when a bending movement greater than the allowed deflection occurs. System designers should provide anchors (main and intermediate) and pipe guides with proper spacing to protect the system from unexpected large bending movements.

These illustrations are examples only, and are not intended to be used for all installations as conditions and requirements vary from job to job. Reliance on general data or information contained herein shall be at the user's sole risk and without obligation to Shurjoint.

Hangers shall be designed to support five times the weight of water-filled pipe plus 250 lb (115 kgs) at each point of pipe support (NFPA 13 9.1.1.1.). The following illustrations are examples of acceptable hanger types and sizes per NFPA 13.

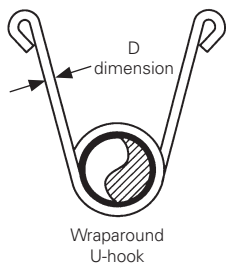

U-Hook sizes

Pipe size in	D dimension in / mm
~ 2	5/16 (7.9)
2½ ~ 6	¾ (9.5)
8	1 (12.7)

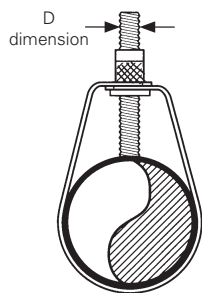

Rod sizes

Pipe size in	D dimension in / mm
~ 4	¾ (9.5)
5 ~ 8	1 (12.7)
10 ~ 12	1¼ (15.9)

Adjustable swivel Ring - rod tight to pipe

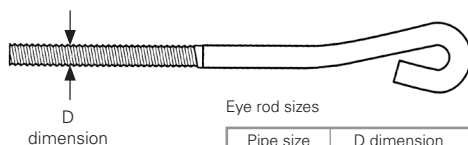

Eye rod sizes

Pipe size in	D dimension in / mm
~ 4	¾ (9.5)
5 ~ 6	1 (12.7)
10 ~ 12	1¼ (15.1)

Hangers for straight runs

For straight runs, you can use both flexible and rigid couplings. When rigid couplings are used, the same hanger spacing as other piping methods can be applied. You can refer to the hanger spacing standards of ANSI B31.1 Power Piping Code, B31.9 Building Services Piping Code, NFPA 13 Sprinkler Systems, or *Mechanical Equipment Construction Guide (Japan)*. See the table below.

Nominal Pipe Size in/mm	Water Service (feet / meters)				Gas or Air Service (feet / meters)		
	1)	2)	3)	4)	1)	2)	3)
1 / 25	7 / 2.1	9 / 2.7	12 / 3.7	6.6 / 2.0	9 / 2.7	10 / 3.0	12 / 3.7
1¼ / 32	7 / 2.1	11 / 3.4	12 / 3.7	6.6 / 2.0	9 / 2.7	12 / 3.7	12 / 3.7
1½ / 40	7 / 2.1	12 / 3.7	15 / 4.6	6.6 / 2.0	9 / 2.7	13 / 4.0	15 / 4.6
2 / 50	10 / 3.0	13 / 4.0	15 / 4.6	6.6 / 2.0	13 / 4.0	15 / 4.6	15 / 4.6
2½ / 65	11 / 3.4	15 / 4.6	15 / 4.6	6.6 / 2.0	14 / 4.3	17 / 5.2	15 / 4.6
3 / 80	12 / 3.7	16 / 4.9	15 / 4.6	6.6 / 2.0	15 / 4.6	19 / 5.8	15 / 4.6
4 / 100	14 / 4.3	18 / 5.5	15 / 4.6	6.6 / 2.0	17 / 5.2	21 / 6.4	15 / 4.6
5 / 125	16 / 4.9	20 / 6.1	15 / 4.6	6.6 / 2.0	20 / 6.1	24 / 7.3	15 / 4.6
6 / 150	17 / 5.2	21 / 6.4	15 / 4.6	10 / 3.0	21 / 6.4	26 / 7.9	15 / 4.6
8 / 200	19 / 5.8	23 / 7.0	15 / 4.6	10 / 3.0	24 / 7.3	29 / 8.8	15 / 4.6
10 / 250	19 / 5.8	25 / 7.6	15 / 4.6	10 / 3.0	24 / 7.3	33 / 10.1	15 / 4.6
12 / 300	23 / 7.0	26 / 7.9	15 / 4.6	10 / 3.0	30 / 9.1	36 / 11.0	15 / 4.6
14 / 350	23 / 7.0	26 / 7.9	15 / 4.6		30 / 9.1	37 / 11.3	15 / 4.6
16 / 400	27 / 8.2	26 / 7.9	15 / 4.6		35 / 10.7	40 / 12.2	15 / 4.6
18 / 450	27 / 8.2	27 / 8.2	15 / 4.6		35 / 10.7	43 / 13.1	15 / 4.6
20 / 500	30 / 9.1	27 / 8.2	15 / 4.6		39 / 11.9	46 / 14.0	15 / 4.6
24 / 600	32 / 9.8	26 / 7.9	15 / 4.6		42 / 12.8	50 / 15.2	15 / 4.6

- 1) ANSI B31.1 Power Piping Code
- 2) ANSI B31.9 Building Services Piping Code
- 3) NFPA 13 Sprinkler systems
- 4) Ministry of Land & Transportation of Japan: Mechanical Equipment Construction Guide

Hanger locations on straight runs where flexible couplings are used

When flexible couplings are used on straight runs, location of hangers shall be designed as close to each coupling as possible, or within a distance of less than 1/6 the span.

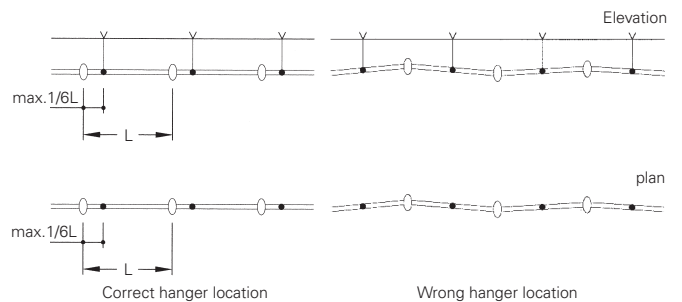

Hanger locations on curved pipe runs and branch lines

Additional hangers or supports shall be provided where runs are curved, connected to a branch line or on short risers or drops.

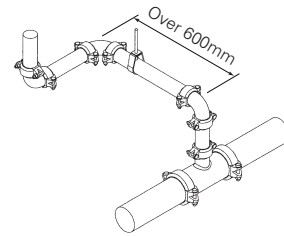
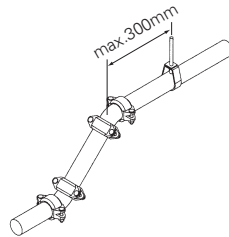
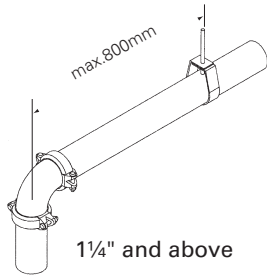
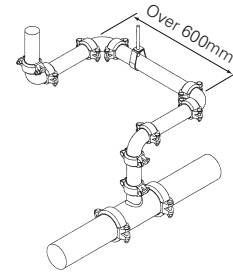
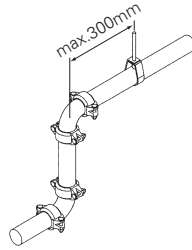
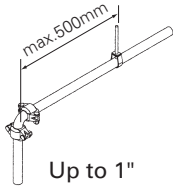

Curved pipe runs

Short riser (or short drop)

Branch line

Typical designs of hangers and sway braces for pipe runs

Pipe runs shall be adequately suspended by rod hangers or steel angles that are directly attached to the building structure to restrict

the movement of the piping. Hangers and their components shall be ferrous. The maximum distance between hangers shall not exceed that specified in the table of previous page.

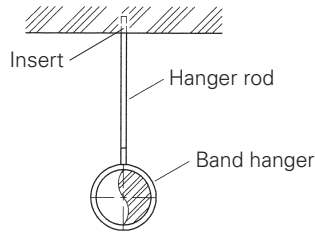

A rod hanger for a single pipe run

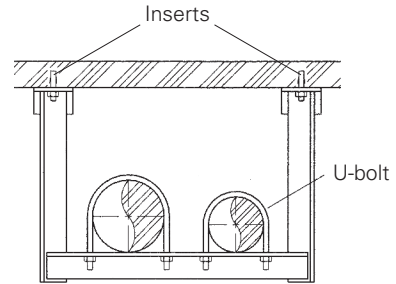

A trapeze hanger suspended from ceiling

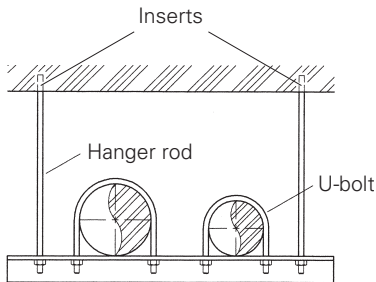

A trapeze hanger for multiple pipe runs

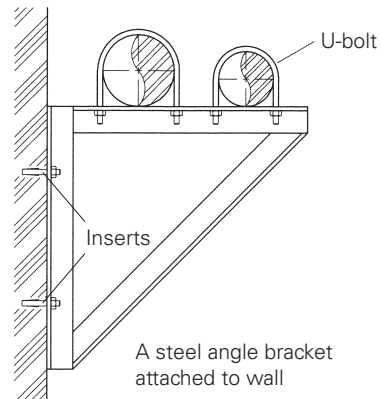

A steel angle bracket attached to wall

Supports for risers

In multi-story buildings, risers shall be fixed (or anchored) at the lowest level and at the top of the riser and shall be supported by riser clamps or U-bolts at each floor level to prevent the risers from swaying. If risers are braced by the penetration floors, the number of riser clamps or U-bolts may be reduced to one at each three stories.

For risers, either flexible or rigid couplings can be used as long as proper anchoring and support is provided.

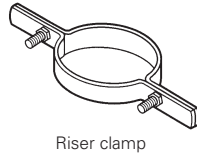

Riser clamp

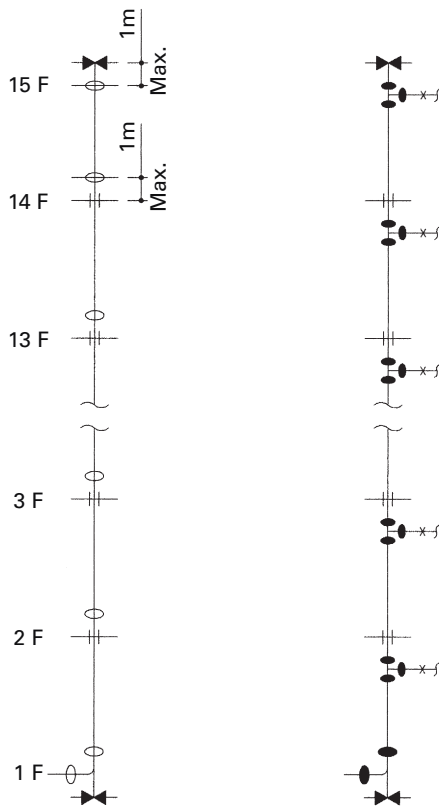

- Flexible Coupling
- Rigid Coupling
- Anchor
- ++ Sway brace

Anchors for risers (➤➤)

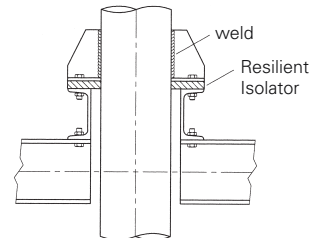

Sway braces for risers (++)

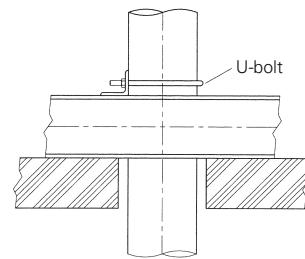

Anchor (➤➤)

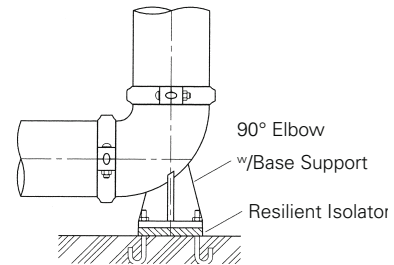

Sway brace (++)

Sway brace (++)

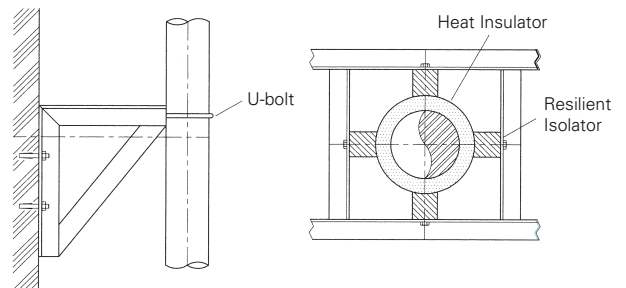

- Anchors should be sufficient to hold the weight of water-filled pipe and pressure thrusts.
- Pipe guides (sway braces) should be such as to brace lateral movement of the system.

Gasket Selection Guide

Over the past 50 years great advances have been made in synthetic elastomer technologies, allowing us to offer a full range of gasket materials for a wide variety of piping applications. **Shurjoint** utilizes the finest materials available in our gaskets which are engineered and designed to meet and exceed industry standards such as ASTM D2000, AWWA C606, NSF61, IAPMO, etc. Our continual research, development and testing all serve to advance this field and to develop new and superior solutions for our changing industry. Selecting the proper gasket for the intended service application requires careful consideration of many factors to assure maximum gasket life. Those factors include temperature, fluid media and concentration, and continuity of service. The gaskets color coding helps to identify the gasket grade and compound.



Gasket Grade Index

Compound	Grade	Color Code	General Service Recommendations	Maximum Temp. Range
EPDM	E	Green Stripe	Good for cold & hot water up to +230°F (+110°C). Also good for services for water with acid, water with chlorine, deionized water, seawater and waste water, dilute acids, oil-free air and many chemicals. Not recommended for petroleum oils, mineral oils, solvents and aromatic hydrocarbons.	-30°F (-34°C) to +230°F (+110°C)
EPDM	EHM	Green and Red Stripes	Good for cold & hot water up to +250°F (+121°C). Also good for services for water with acid, water with chlorine, deionized water, seawater and waste water, dilute acids, oil-free air and many chemicals. The Grade "EHM" gasket is only available on Shurjoint Quick Install Couplings. Not recommended for petroleum oils, mineral oils, solvents and aromatic hydrocarbons.	-30°F (-34°C) to +250°F (+121°C)
Nitrile	T	Orange Stripe	Good for petroleum oils, mineral oils, vegetable oils, non-aromatic hydrocarbons, many acids and water ≤+150°F (+65°C).	-20°F (-29°C) to +180°F (+82°C)
EPDM	E-pw	Double Green Stripe	Specially compounded for cold +86°F (+30°C) and hot +180°F (+82°C) potable water services. The compound is UL classified per NSF/ANSI 61 & NSF/ANSI 372.	-30°F (-34°C) to +230°F (+110°C)
EPDM	Lube-E (E-A)	Green and Violet Stripe	UL approved pre-lubricated gasket designed specifically only for the fire protection industry.	Ambient
White Nitrile	A	White Gasket	Good for oily and greasy food products and processing, as well as pharmaceutical and cosmetics manufacturing. Compounded from FDA approved ingredients (CFR Title 21 Part 177.2600).	+20°F (-7°C) to +180°F (+82°C)
Silicone	L	Red Gasket	Good for dry, hot air without hydrocarbons and some high temperature chemical services.	-30°F (-34°C) to +350°F (+177°C)
Neoprene	V	Yellow Stripe	Good for hot lubricating oils and certain chemicals.	-30°F (-34°C) to +180°F (+82°C)
Fluoro-elastomer	O	Blue Stripe	Good for many oxidizing acids, petroleum oils, halogenated hydrocarbons, lubricants, hydraulic fluids, organic liquids and air with hydrocarbons to +300°F (+149°C).	+20°F (-7°C) to +300°F (+149°C)
Epichloro-hydrin	M2	White Stripe	Good for aromatic fuels at low temperatures and also for ambient temperature water.	-40°F (-40°C) to +160°F (+71°C)

Special Gaskets for AWWA ductile iron pipe

Compound	Grade	Color Code	General Service Recommendations	Maximum Temp. Range
Nitrile	S	Red Stripe	Specially compounded for use with AWWA ductile iron pipe and used for petroleum products, mineral oils, vegetable oils and air with oil vapors.	-20°F (-29°C) to +180°F (+82°C)
Halogenated Butyl	M	Brown Stripe	Good for water services, mild dilute acids, oil-free air and many chemicals. The compound is UL classified per NSF/ANSI 61 & NSF/ANSI 372.(AWWA ductile iron pipe use)	-20°F (-29°C) to +200°F (+93°C)

NOTE: Service conditions, which include, but are not limited to; service fluids, concentrations, combination of fluids, temperature exposure, constant temperature cycling, and incompatible fluids can reduce service life and performance. As such, gaskets are considered a wear part and should be replaced as service conditions demand.



WARNING !

EPDM gaskets for water services are not recommended for steam services. **Shurjoint** EHC silicone lubricant should not be used on Silicone Compound gaskets.

Compatibility of all elastomer's in a given system should be aligned in regard to service conditions, temperature, and media.

Failure to select the proper gasket and compound may result in joint leakage or failure resulting in personal injury and/or property damage. Gaskets should never be exposed to temperatures outside their ratings. Recommended services do not necessarily imply compatibility. Suitability of gasket grade and coupling design must be verified by a competent person familiar with individual system designs and specifications.

Gasket Selection Guide

*Proper gasket selection is essential for the optimum performance of **Shurjoint** grooved couplings, flange adapters and mechanical tees.*

1. Gasket styles: Shurjoint grooved couplings utilize several different gasket styles, standard, GapSeal, EP (End Protection) and FF (Fast Fit). GapSeal gaskets are compatible with standard gaskets and they are interchangeable with each other. Other special styles are not compatible with standard or GapSeal gaskets. Always use the correct gasket style for the coupling model you selected.

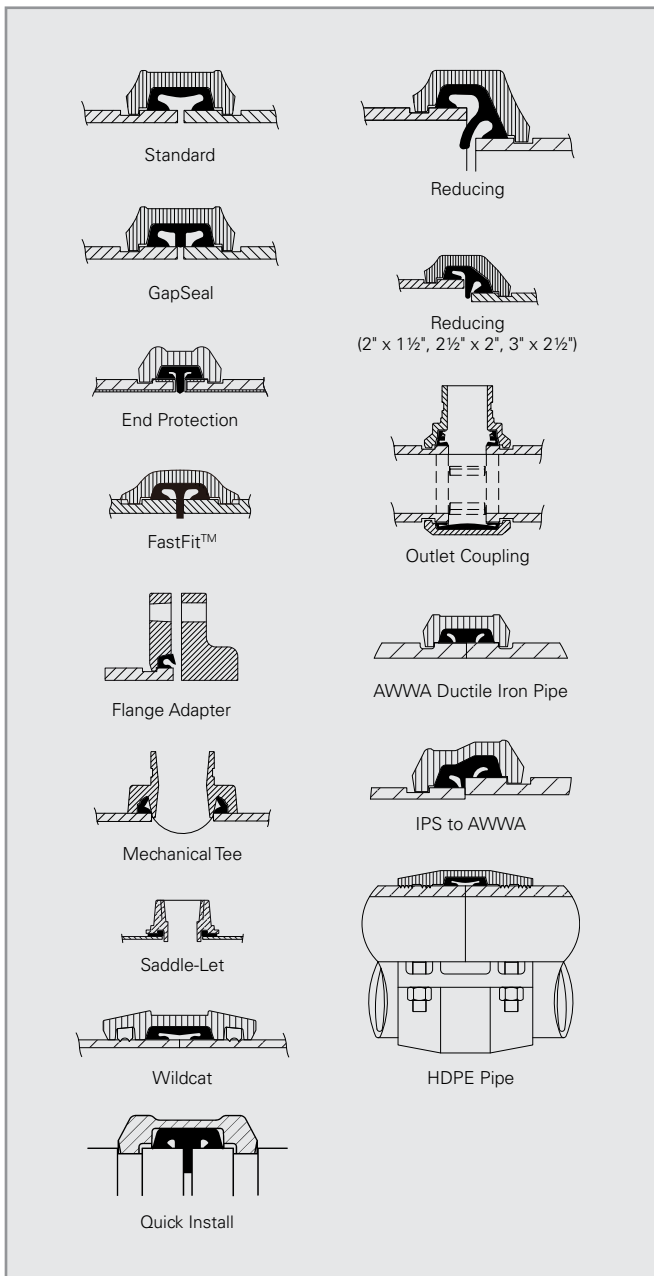

2. Vacuum service: Shurjoint standard gaskets are designed to seal well under vacuum conditions up to 10 inHg (absolute)/254 mmHg (absolute) which may occur when a system is drained. For continuous services greater than 10 inHg (absolute)/254 mmHg (absolute), the use of GapSeal gaskets or EP (End Protection) gaskets in combination with rigid style couplings is recommended. Contact **Shurjoint** for specific recommendations.

3. Dry pipe and freezer services: Shurjoint recommends the use of GapSeal Grade "E" gaskets for dry pipe fire protection systems and freezer applications. The GapSeal gasket closes off the gap between the pipes or gasket cavity. This will prevent any remaining liquid from entering the cavities and freezing when the temperature drops. Rigid couplings are preferred for dry pipe, freezer and vacuum applications. Reducing couplings are not recommended for these applications.

NOTE: For gaskets in service temperatures above 150°F (65°C), or below 33°F (0.5°C) the use of Shurjoint EHC silicone lube is required and has demonstrated increased gasket performance and longevity in testing.

4. NSF/ANSI 61 Standard: NSF/ANSI 61 classified gaskets are good for potable water services. The classification categories are 'cold' which is limited to +86°F (+30°C) (or maximum ambient distribution temperatures of unheated water) maximum and 'hot' which is limited to +180°F (+82°C) (or scalding temperatures of hot domestic water).

5. NSF/ANSI 372 Standard: Maximum Lead Content (formerly Annex G): Product complies with NSF/ANSI 372 and conforms with lead content requirements for "lead free" plumbing as defined by California, Vermont, Maryland and Louisiana State laws and the U. S. Safe Drinking Water Act in effect as of Jan. 4, 2014.

6. Lubricant: Shurjoint Lubricant is recommended for proper gasket installation to prevent the gasket from being pinched. Apply a thin coat to the gasket exterior, gasket lips and/or housing interiors. **Shurjoint's** new quick install couplings do not require an external gasket lubricant on initial installation. Lubrication is required on the sealing lips and internal areas. **Shurjoint** Lubricant is available in one pound (450 grams) and one quart (2 pounds or 900 grams) containers. Certified to NSF/ANSI 61.



General Gasket Service Recommendations

The following are general service recommendations only and the information provided is based on the best information available from various resources including elastomer manufacturers, leading rubber molders, industry publications and our own laboratory testing and field experience. The information contained herein shall be considered for evaluation purposes and

not as a guarantee. When and wherever possible, gasket materials should be tested with simulated service conditions to determine suitability for the intended service application. Unless otherwise noted, the recommendations are based on ambient temperatures. These recommendations do not apply to rubber lined products or rubber sealed valves. If more than one gasket

grade is listed the preferred grade is listed first for general services. For chemicals not listed, a combination of chemicals listed or not, service temperatures not listed or borderline services, contact a **Shurjoint** Engineering Representative for a recommendation.

Note: NR = Not Recommended

CHEMICAL SERVICES	
Chemical Composition	Gasket Grade
Acetaldehyde	E
Acetamide	T
Acetic Acid up to 10% 100°C (38°C)	E/L
Acetic Acid up to 10-50% 100°C (38°C)	L
Acetic Acid, Glacial 100°C (38°C)	L
Acetic Anhydride	E
Acetone	E
Acetonitrile	E/T
Acetophenone	E
Acetylene	E/T
Acrylic Resin	V
Acrylonitrile	NR
Adipic Acid	T
Air, oil free	E
Air with vaped oil	T
Alkalis	E
Allyl Alcohol to 96%	E
Allyl Chloride	NR
Alum Sulfuric Acid	O
Alums	E/T
Aluminum Chloride	E/T
Aluminum Fluoride	E/T/O
Aluminum Hydroxide	E/O
Aluminum Nitrate	E/TV
Aluminum Oxychloride	T
Aluminum Phosphate	E
Aluminum Salts	E/T
Aluminum Sulfate	E/T
Alums	E/T
Ammonia Anhydrous (Pure Ammonia)	NR
Ammonia Gas, Cold	E
Ammonia, Aqua, 10-25%	E
Ammonia, Liquid	E
Ammonium Alum	V
Ammonium Bifluoride	T
Ammonium Carbonate	E
Ammonium Chloride	E/T
Ammonium Fluoride	E
Ammonium Hydroxide	E
Ammonium Metaphosphate	E
Ammonium Nitrate	E/T
Ammonium Nitrite	E
Ammonium Persulfate, to 10%	E
Ammonium Phosphate	T
Ammonium Sulfamate	T
Ammonium Sulfate	E/T

CHEMICAL SERVICES	
Chemical Composition	Gasket Grade
Ammonium Sulfide	E
Ammonium Thiocyanate	E
Amyl Acetate	E
Amyl Alcohol	E
Amyl Borate	V
Amyl Chloride	NR
Amyl Chloronaphthalene	T
Anderol	O
Aniline	E
Aniline Dyes	E
Aniline Hydrochloride	E
Aniline Oil	E
Animal Fats	A
Anthraquinone	NR
Anthraquinone Sulfonic Acid	NR
Antimony Chloride	E
Antimony Trichloride	E
Argon Gas	E/O
Aroclor(S)	O
Arsenic Acid, to 75%	E/T/O
Arylsulfonic Acid	NR
ASTM #1, 2 & 3 Oil	T
Barium Carbonate	E
Barium Chloride	E/T
Barium Hydroxide	E/T
Barium Nitrate	V
Barium Sulfide	T
Beer	A
Beet Sugar liquors	A
Benzaldehyde	E
Benzene	O
Benzine (see Petroleum Ether)	O
Benzoic Acid	E
Benzol	O
Benzyl Alcohol	E
Benzyl Benzoate	E
Benzyl Chloride	E
Black Sulfate Liquor	T
Blast Furnace Gas	T
Bleach, 12% Active Cl ₂	E
Borax Solutions	E
Bordeaux Mixture	E
Boric Acid	E/T
Bromine	O
Bromine Water	V
Butane Gas	T

CHEMICAL SERVICES	
Chemical Composition	Gasket Grade
Bromotoluene	NR
Butanol (see Butyl Alcohol)	E/T
Butter	A
Butyl Acetate Ricinoleate	E/T
Butyl Alcohol	E/T
Butyl "Cellosolve Adipate"	E/T
Butyl Phenol	E
Butyl Stearate	T/O
Butylene	T/O
Butylene Glycol	E
Butyne Diol	NR
Calcium Acetate	T
Calcium Bisulphite	T/O
Calcium Carbonate	E/T
Calcium Chlorate	E/T
Calcium Chloride	E/T
Calcium Hydroxide (Lime)	E/T
Calcium Hypochlorite	E
Calcium Hypochloride	E
Calcium Nitrate	E/T/V
Calcium Sulfate	E/T
Calcium Sulfide	E/T
Caliche Liquors	T
Cane Sugar Liquors	A
Carbitol	E/T
Carbonic Acid, Phenol	O
Carbon Bisulphide	O
Carbon Dioxide, Dry	E/T
Carbon Dioxide, Wet	E/T
Carbon Disulphide	O
Carbon Monoxide	E
Carbon Tetrachloride	O
Carbonic Acid, Dry	O
Caster Oil	T/A
Caustic Potash	E/T
Cellosolve	E/V
Cellosolve Acetate	E
Cellosolve (Alcohol Ether)	E
Cellulose Acetate	E
Cellulube 220 (Tri-Aryl-Phosphate)	E
Cellulube Hydraulic Fluids	E
China Wood Oil, Tung Oil	T
Chloric Acid to 20%	E
Chlorine, Dry	O
Chlorine, Water 4000 PPM (max.)	E
Chlorinated Paraffin (Chlorococane)	T

CHEMICAL SERVICES	
Chemical Composition	Gasket Grade
Chloroacetic Acid	E
Chloroacetone	E
Chlorobenzene	O
Chloralhydrate	NR
Chlorobromomethane	NR
Chloroform	O
Chlorosulphonic Acid	NR
Chrome Alum	E/T
Chromic Acid, to 10%	O
Chromic Acid, to 25%	O
Chrome Plating Solutions	O
Citric Acid, Saturated	E
Citric Acid	E/T
Coconut Oil	A
Cod Liver Oil	A
Coke Oven Gas	T/O
Copper Carbonate	E/T
Copper Chloride	E/T
Copper Cyanide	E/T
Copper Fluoride	E
Copper Nitrate	E/T
Copper Sulfate	E/T
Corn Oil	A
Cotton Seed Oil	A
Creosol, Cresylic Acid	O
Creosote, Coal Tar	T/O
Creosote, Wood	T/O
Cupric Fluoride	E/T
Cupric Sulfate	E/T
Cyclohexane (Alicyclic Hydrocarbon)	O
Cyclohexanol	V/O
Cyclohexanone	E
Deionized Water	E
Dextrin	T
Diacetone Alcohol	V
Dibutyl Phthalate	E
Dichloro Difloro Methane	T
Dicyclohexylamine	T
Diesel Oil	T
Diethyl Ether	T
Diethyl Sebacate	E
Diethylamine	T
Diethylene Glycol	E/T
Digester Gas	T
Dimethylamine	T
Diocetyl Phthalate	E
Dioxane	E
Dipentene(Terpene-Hydrocarbon)	T
Dipropylene Glycol	T
Dowtherm A	O
Dowtherm E	O
Dowtherm SR-1	T/E
Ethane	E
Ethanolamine	E
Ethers	NR
Ethyl Acetoacetate	E
Ethyl Acrylate	L
Ethyl Alcohol (Ethanol)	E
Ethyl Cellulose	E

CHEMICAL SERVICES	
Chemical Composition	Gasket Grade
Ethyl "Cellusolve"	E
Ethyl Chloride	E/T
Ethyl Ether	T
Ethyl Oxalate	E
Ethyl Silicate	T
Ethylene Chlorohydrin	E
Ethylene Diamine	E/T
Ethylene Dichloride (Dichloroethane)	O
Ethylene Glycol	E/T
Ethylene Oxide	NR
Fatty Acid	A
Ferric Chloride, to 35%	E/T/O
Ferric Chloride, Saturated	E
Ferrous Nitrate	V
Ferric Hydroxide	E
Ferric Sulfate	T
Fish Oils (Solubles)	A
Fire Fighting Foam Concentrate	E/O
Fluboric Acid	E/T
Fluorine Gas, Wet	NR
Fluorosilicic Acid, to 30%	V
Fly Ash	E
FM200 HFC-227ea	E
Foam	E
Fog Oil	T
Formaldehyde	E/T
Formamide	E/T
Formic Acid, to 25%	E
Freon 11, 130°F (54°C)	T
Freon 12, 130°F (54°C)	T
Freon 113 130°F (54°C)	T
Freon 114, 130°F (54°C)	T
Freon F-12	T
Freon 123	NR
Freon 134a, 176° (80°C)	E/T
Freon F-21	NR
Freon 22, 130°F (54°C)	V
Fructose	E/T
Fuel Oil	T
Fumaric Acid	E
Furan	NR
Furfuryl Alcohol	E
Gallic Acid	NR
Gasoline, Refined	T
Gasoline, Refined, Unleaded	O
Gelatin	A
Glucose	A
Glue	E/T
Glycerin	E/T
Glycerol	E/T
Glycol	E/T
Glycolic Acid	E
Grease	T/V/O
Green Sulfate Liquor	T
Halon 1301	E
Heptane	T
Hexaldehyde	E
Hexane	T
Hexanol	V/T

CHEMICAL SERVICES	
Chemical Composition	Gasket Grade
Hexanol Tertiary	T
Hexyl Alcohol	V/T
Hexylene Glycol	T
Hydrobromic Acid, to 40%	E
Hydrochloric Acid, to 36%, 75°F (24°C)	E
Hydrochloric Acid, to 36%, 158°F (70°C)	O
Hydrocyanic Acid	E
Hydrofluoric Acid, to 75%, 75°F (24°C)	O
Hydrofluosilicic Acid	E
Hydrocyanic Acid, to 10%	E
Hydrofluoric Acid, to 30%	V/O
Hydrofluosilicic Acid, to 50%	T
Hydrogen Phosphide	NR
Hydrogen Gas, Cold	E/T
Hydrogen Gas, Hot	E
Hydrogen Peroxide, to 50%	L
Hydrogen Peroxide, to 90%	O
Hydrogen Sulfide	E
Hydroquinone	T/O
Hydroxylamine Sulfate	E
Hypochlorous Acid, Dilute	E
Isododecane	V
Isobutyl Alcohol	E
Iso Octane, 100°F (38°C)	T
Isopropyl Acetate	E
Isopropyl Ether	T
JP-3	T
JP-4	T/O
JP-5	T/O
JP-6, 7, 8	T
Kerosene	T
Ketones	E
Lactic Acid	A
Lard Oil	V
Latex (1% Styrene & Butadiene)	O
Lauric Acid	T
Lauryl Chloride	NR
Lavender Oil	T
Lead Acetate	T
Lead Chloride	E
Lead Sulfamate	V
Lead Sulfate	T
Lime and H2O	E/T
Lime Sulfur	O
Linoleic Acid	O
Lithium Bromide	T
Lithium Bromide (Brine)	T/O
Linseed Oil	A
Lithium Chloride	T/O
Lubricating Oil, Refined	T
Lubricating Oil, Sour	T
Lubricating Oil, to 150°F (66°C)	T
Lubricating Oil, 150°F (66°C) to 180°F (82°C)	V/T
Magnesium Chloride	E/T
Magnesium Hydroxide	E/T
Magnesium Nitrate	E/V
Magnesium Sulfate	E/T
Maleic Acid, Saturate	T

CHEMICAL SERVICES	
Chemical Composition	Gasket Grade
Malic Acid	T
Mercuric Chloride	E/T
Mercuric Cyanide	E/T
Mercurous Nitrate	E/T
Mercury	E/T
Methane	T
Methyl Acetate	V
Methyl Alcohol, Methanol	E/T
Methyl Cellosolve (Ether)	V
Methyl Chloride	O
Methyl Ethyl Ketone	NR
Methyl Isobutyl Carbinol	E
Methylene Chloride	O
Methylene Chlorobromide	NR
Methylene Dichloride 100°F (38°C)	O
MIL-L7808	O
MIL-05606	O
MIL-08515	O
Milk	A
Mineral Oils	T
Naphta	O
Naotalene	NR
Naphta, 160°F (71°C)	O
Napthenic Acid	T
Neatsfoot Oil	T
Nevoil	E
Nickel Acetate to 10%, 100°F (38°C)	V
Nickel mmonium Sulfate	V
Nickel Chloride	E/T
Nickel Nitrate	V
Nickel Plating Solution 125°F (52°C) - Max.	E/T
Nickel Sulfate	E/T
Nitric Acid to 10%, 75°F (24°C) - Max.	E
Nitric Acid, 10-50%, 75°F (24°C) - Max.	O
Nitric Acid, 50-86%, 75°F (24°C)	O
Nitric Acid, Red Fuming	O
Nitrocellulose	V
Nitrogen	E
Nitromethane	E
Nitrous Oxide	E
NOVEC 1230 FK-5-1-12	E
Octyl Alcohol VOgisogiric Acid, to 75%, 150°F (66°C)	O
Oil, Crude Sour	T
Oil, Motor	T
Oleic Acid	T
Oilve Oil	T/A
Oronite 8200 Silicate Ester Fluid	O
Orthodichlorobenzene	O
OS-45 Silicate Ester Fluid	O
OS-45-1	O
Oxalic Acid	E
Oxygen, Cold	E
Ozone (100 ppm)	E
Palm Oil	T/A
Peanut Oil	A
Palmitic Acid	T
Pentane	T

CHEMICAL SERVICES	
Chemical Composition	Gasket Grade
Perchloric Acid	NR
Perchloroethylene	O
Petroleum Ether (see Benzene)	O
Petroleum Oils	T
Phenol (Carbolic Acid)	O
Phenylhydrazine	E
Phenylhydrazine Hydrochloride	E
Phosphate Ester	E
Phosphoric Acid, to 50%	E
Phosphoric Acid, to 75% and 70°F	E/T
Phosphoric Acid, to 85%, 150°F (66°C) - Max.	O
Phosphate Ester	E
Photographic Solutions	T
Phthalic Anhydride	E
Picric Acid	V
Plating Solutions, (gold, brass cadmium, copper, lead, silver, tin, zinc)	V
Polybutene	T
Polyvinyl Acetate, Solid (In Liquid State is 50% solution of Methanol or 60% solution of H2O)	E
Potash	E
Potassium Alum	E/T
Potassium Aluminum Sulfate	E/T
Potassium Bicarbonate	E/T
Potassium Bichromate	E/T
Potassium Borate	E
Potassium Bromate	E
Potassium Bromide	E/T
Potassium Carbonate	E/T
Potassium Chlorate	E
Potassium Chloride	E/T
Potassium Chromate	T
Potassium Cyanide	E/T
Potassium Dichromate	E
Potassium Ferricyanide	E
Potassium Ferrocyanide	E
Potassium Fluoride	E
Potassium Hydroxide	T
Potassium Iodide	V
Potassium Nitrate	E/T
Potassium Perborate	E
Potassium Perchlorate	T
Potassium Permanganate, Saturated to 10%	E
Potassium Permanganate Saturate 10-25%	E
Potassium Persulfate	T
Potassium Silicate	E/T/V
Potassium Sulfate	E/T
Prestone	T
Propane Gas	T
Propanol	E/T
Propargyl Alcohol	E
Propyl Alcohol	E/T
Propylene Dichloride	L
Propylene Glycol	E
Pydraul F-9 and F-150	NR

CHEMICAL SERVICES	
Chemical Composition	Gasket Grade
Pyranol 1467	T
Pyranol 1476	T
Pyroguard "C"	T
Pyroguard "D"	T
Pyroguard 55	E
Pyrrole	E
Ref. Fuel (70 ISO Octane, 30 Toluene)	T
Rapeseed Oil	A
Rosin Oil	T/V
Salicylic Acid	E
Secondary Butyl Alcohol	T
Sewage	E/T
Silver Nitrate	E
Silver Sulfate	E
Skydrol, 200°F (93°C) - Max.	L
Skydrol 500 Phosphate Ester	E
Soap Solutions	E/T
Soda Ash, Sodium Carbonate	E/T
Sodium Acetate	E
Sodium Alum	T
Sodium Benzoate	E/T
Sodium Bicarbonate	E/T
Sodium Bisulfate	E/T
Sodium Bisulfite (Black Liquor)	E/T
Sodium Bromide	E/T
Sodium Carbonate	E/T
Sodium Chlorate	E
Sodium Chloride	E/T
Sodium Cyanide	E/T
Sodium Dichromate, to 20%	E/T
Sodium Ferricyanide	E/T
Sodium Ferrocyanide	E/T
Sodium Fluoride	E/T
Sodium Hydroxide, to 15%	E
Sodium Hydro Sulfide	T
Sodium Hydroxide to 50%	E
Sodium Hypochlorite, to 20%	E
Sodium Metaphosphate	T
Sodium Nitrate	E
Sodium Nitrite	E/T
Sodium Perborate	E
Sodium Peroxide	E
Sodium Phosphate	T
Sodium Phosphate, Dibasic	T
Sodium Phosphate, Monobasic	T
Sodium Phosphate, Tribasic	T
Sodium Silicate	T
Sodium Sulfate	E/T
Sodium Sulfide	E/T
Sodium Sulfite Solution, to 20%	T
Sodium Thiosulfate, "Hypo"	T
Sohovis 47	T
Sohovis 78	T
Solvasol #1	T
Solvasol #2	T
Solvasol #3	T
Solvasol #73	T
Solvasol #74	NR
Soybean Oil	A

CHEMICAL SERVICES	
Chemical Composition	Gasket Grade
Spindle Oil	T
Stannic Chloride	T
Stannous Chloride, to 15%	T
Starch	E/T
Steam	NR
Stearic Acid	T
Stoddard Solvent	T
Styrene	O
Sulfonic Acid	E
Sulphite Acid Liquor	E
Sucrose Solutions	A
Sulfur	E/V
Sulfur Chloride	O
Sulfur Dioxide, Dry	E
Sulfur Dioxide, Wet	E
Sulfur Trioxide, Dry	O
Sulfuric Acid, to 25%, 150°F (66°C)	E
Sulfuric Acid, 25-50%, 200°F (93°C)	O
Sulfuric Acid, 50-95%, 150°F (66°C)	O
Sulfuric Acid, Fuming	O
Sulfuric Acid, Oleum	O
Sulfurous Acid	O
Tall Oil	T
Tannic Acid, all conc. Tanning Liquors (50g. alum. solution, 50g. dichromate solution)	V
Tartaric Acid	E
Tertiary Butyl Alcohol	E/T
Tetrabutyl Titanate	E
Tetrachloroethylene	O
Thionyl Chloride	T
Terpineol	V
Tertiary Butyl Alcohol	E/T/V
Tetrachloroethylene	O
Tetrahydrofuran	NR
Tetralin	NR
Thiopene	NR
Titanium Tetrachloride	O
Toluene, to 30%	T
Transmission Fluid, Type A	O
Triacetin	T
Trichloroethane	O
Trichloroethylene	O
Trichloroethylene, to 200°F (93°C)	O
Tricresyl Phosphate	E
Triethanolamine	E/T
Trisodium Phosphate	E
Tung Oil	T
Turbo Oil #15 Diester Lubricant	O
Turpentine	T
Urea	T/E
Vegetable Oils	T/A
Vinyl Acetate	E
Vinegar	A
Vinyl Chloride	O
Vi-Pex	T
Water, to 150°F (66°C)	E/T/M/S
Water, to 200°F (93°C)	E/M
Water, to 230°F (110°C)	E

CHEMICAL SERVICES	
Chemical Composition	Gasket Grade
Water, to 250°F (121°C)	EH
Water, Acid Mine	E/T
Water, Bromine	O
Water, Chlorinated, to 3500 ppm	E
Water, Chlorine	E
Water, Deionized	E/M
Water, Potable	E-pw
Water, Seawater	E
Water, Waste	E/T/M/S
Whiskey	A
White Liquor	E
Wood Oil	T
Xylene	O
Zinc Chloride, to 50%	E
Zinc Nitrate	E
Zinc Sulfate	E/T



WARNING !

Gaskets should never be exposed to temperatures outside their ratings. EPDM gaskets for water services are not compatible for steam services. Failure to select the proper gasket and compound may result in joint leakage or failure resulting in personal injury and/or property damage. Shurjoint warrants its gaskets against defects and workmanship. Shurjoint expressly disclaims all other warranties, either expressed or implied, including the warranties of merchantability and fitness for a particular purpose. Additionally, **Shurjoint** does not warranty gaskets for use under any specific applications or service conditions. For more details and support, please contact **Shurjoint**.

Fire Protection Services

The **Shurjoint** fire protection series numbers over 600 individual components, including grooved couplings, fittings, flanges, mechanical tees, valves, welding outlets, threaded fittings and more. Applicable products are listed and or approved by various domestic and international approval bodies including UL, FM, VdS, LPCB and others.

Hydrostatic Tests Approved products are rated in cold water pressure (CWP) tested with a 3 to 5 times test pressure depending on the approval body and pipe size. The minimum working pressure (CWP) shall be 175 psi (12.3 Bar) in accordance with NFPA 13. Approval testing of a coupling is conducted on all different pipe schedules as enrolled and approved working pressures (CWP) are assigned to each individual combination of the coupling and test pipe. Refer to the Approved Pressure Ratings by UL and FM.

Hydrostatic Test Pressures (= multiple of CWP)

Nom. Size	UL	FM	VdS	LPCB
Up to 6" / 150	X5	X4	X4	X4
8" - 12" / 200-300	X4	X4	X4	X4
14" and above	X3	X4	NA	NA

Contact Shurjoint for other approvals.

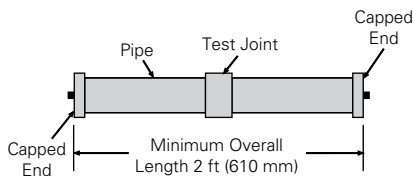

Bending Moment Tests The required bending moment per UL and FM is calculated based on twice the weight of water filled pipe over twice the maximum distance between pipe supports as specified in NFPA 13.

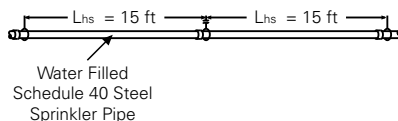

See the table below for the bending moments per UL and FM on Sch. 40 pipe. This bending moment is twice that required by ASTM F1476 (refer to page 15).

Required Bending Moment by UL & FM

Nom. Size (inches)	UL		FM	
	Moment Nm	Moment Lbs-Ft	Moment Nm	Moment Lbs-Ft
1½	1098	810	1100	810
2	1559	1150	1560	1150
2½	2400	1770	2400	1770
3	3289	2426	3290	2425
4	4942	3645	4975	3670
5	7102	5238	7105	5240
6	9606	7085	9615	7090
8	15326	11304	15335	11310
10	22757	16785	22790	16805
12	31116	22950	31145	22970
14	37217	27450		
16	48597	35843		

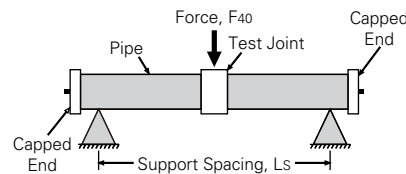

In addition to the hydrostatic and bending moment tests, couplings must meet other requirements including gasket performance tests.

Flexible Coupling NFPA 13 defines a flexible coupling as "a listed coupling or fitting that allows axial displacement, rotation, and at least 1 degree of angular movement of the pipe without inducing harm on the pipe. For pipe diameters of 8 in. and larger, the angular movement shall be permitted to be less than 1 degree but not less than 0.5 degrees." (NFPA 13 - 2007 3.5.4)

For sprinkler systems, NFPA 13 specifies the use of flexible couplings to protect the system against damage from earthquakes and lists some specific examples of how and where they should be used. Designers and installers should design their fire protection systems in compliance with this standard. See Typical Applications – Flexible Couplings on Page 191.

Minimum Pipe Schedules Standard cut and roll grooving connections have limitations of minimum pipe schedules. Special care is required for thin wall pipe. Factory Mutual Research Group (FM) outlines the minimum pipe schedules to be used for cut and roll grooving in their FM Class 1920 standard as follows:

Nominal Pipe Size, in.	Grooving Method	Minimum Pipe Schedule
6 or smaller	Cut	Schedule 40
8 or larger	Cut	Schedule 30
2 or smaller	Rolled	Schedule 5
6 or smaller	Rolled	Schedule 10, Thinwall, Lightwall
8 or larger	Rolled	0.188 in. (4.8 mm) wall

(FM Class 1920 -2007, Table 3.2.2)

Approved Pressure Ratings by UL & FM

- Approved grooved couplings and fittings are good for use in both wet and dry sprinkler systems.
- Typical applications of flexible couplings (models 7705, 7706 & 7707) are in sprinkler risers, in feed mains passing through walls from one building area to another, in locations subject to earthquakes, in the discharge line from aboveground pump suction tanks, in new connections to existing feed mains and in air or water fire service lines subject to excessive vibration or difficult alignment.
- Approved grooved couplings are limited to use with rolled or cut-groove ended pipe, valves and fittings at a minimum rated working pressure of 175 psi (1205 kPa) and are suitable for aboveground service.
- Grooves should be processed according to ANSI/AWWA C606 (latest edition) Grooved and Shouldered Joints.
- Installation must be made according to the manufacturer's instructions and requirements.
- Approved grooved couplings may be used in underground service subject to the installation restrictions placed upon the pipe and to the coupling manufacturer's recommendations and requirements.
- Approved grooved couplings have been evaluated for a maximum ambient temperature of 225°F (107°C), suitable for normal warehouse protection.
- Threaded size of sprinkler piping is limited to 1 inch (25 mm) nominal.
- Threaded connections can be made to approved threadable thinwall pipe or to Schedule 40 pipe.

Source: FM Approval Guide

- For pressure ratings for special pipes, DIN and JIS pipe sizes, and large diameter sizes 14" – 24", contact Shurjoint for details.
- Models K-9 and 7771 rigid couplings are also available. For pressure ratings, contact Shurjoint for details.

Couplings and Flange Adapters

Sch. 40 & STD Wall Pipe

Unit: psi

Size in	Wall in	7705		K-9		7707		7771		Z05		Z07		7041		7043		7706			
		UL	FM	UL	FM	UL	FM	UL	FM	UL	FM	UL	FM	UL	FM	UL	FM	Size (in)	UL	FM	
¾	0.113	-	-	-	-	500	-	-	-	-	-	-	-	-	-	-	-	-	2 x 1½	300	300
1	0.133	300	300	-	-	500	-	-	-	-	-	-	500	-	-	-	-	-	2½ x 2	300	300
1¼	0.140	300	300	300	300	500	-	-	-	350	350	500	500	-	-	-	-	-	3 x 2	300	300
1½	0.145	300	300	300	300	-	500	-	500	350	350	500	500	-	-	-	-	-	3 x 2½	300	300
2	0.154	300	300	300	300	500	500	300	300	350	350	500	500	175	300	300	300	300	4 x 2	300	300
2½	0.203	300	300	300	300	500	500	300	300	350	350	500	500	175	300	300	300	300	4 x 2½	300	300
3	0.216	300	300	300	300	500	500	300	300	350	350	500	500	175	300	300	300	300	4 x 3	300	300
4	0.237	300	300	300	300	500	500	300	300	350	350	500	500	175	300	300	300	300	6 x 3	300	300
5	0.258	300	300	300	300	500	500	300	300	350	350	400	400	175	300	300	300	300	6 x 4	300	300
6	0.280	300	300	300	300	500	500	300	300	350	350	400	400	175	300	300	300	300	8 x 6	300	300
8	0.322	300	300	300	300	500	500	300	300	350	350	400	400	175	300	300	300	-	-	-	-
10	0.375	175 [^]	250	-	-	300	500	175	200	-	-	350	350	175	175	300	300	-	-	-	-
12	0.375	175 [*]	250	-	-	300	300	175	300	-	-	350	350	175 [*]	175	300	300	-	-	-	-

[^]0.188" wall, ^{*}0.330 wall

Unit: psi

Size in	Wall in	7705H	
		UL	FM
8	0.322	450	450

Sch. 10 & BS 1387 Medium Pipe

Unit: psi

Size in	Wall in	7705		K-9		7707		7771		Z05		Z07		7041		7043		7706			
		UL	FM	UL	FM	UL	FM	UL	FM	UL	FM	UL	FM	UL	FM	UL	FM	Size (in)	UL	FM	
¾	0.083	-	-	-	-	500	-	-	-	-	-	-	-	-	-	-	-	-	2 x 1½	300	300
1	0.109	300	300	-	-	500	-	-	-	-	-	-	500	-	-	-	-	-	2½ x 2	300	300
1¼	0.109	300	300	300	300	500	-	-	-	350	350	500	500	-	-	-	-	-	76.1 x 2	300	300
1½	1.109	300	300	300	300	-	-	-	500	350	350	500	500	-	-	-	-	-	3 x 2	300	300
2	0.110	300	300	300	300	450	450	300	300	350	350	500	500	175	300	300	300	300	3 x 2½	300	300
2½	0.120	300	300	300	300	450	450	300	300	350	350	500	500	175	300	300	300	300	3 x 76.1	300	300
76.1	0.142	300	300	300	-	500	500	-	300	300	-	-	-	175	-	-	-	-	4 x 2	300	300
3	0.120	300	300	300	300	450	450	300	300	350	350	500	500	175	300	300	300	300	4 x 2½	300	300
4	0.120	300	300	300	300	450	450	300	300	350	350	500	500	175	300	300	300	300	4 x 76.1	300	300
5	0.134	300	300	300	300	450	450	300	300	350	350	400	400	175	300	300	300	300	4 x 3	300	300
139.7	0.197	300	300	300	-	500	500	-	300	-	-	-	-	175	-	-	-	-	6 x 3	300	300
6	0.134	300	300	300	300	450	450	300	300	350	350	400	400	175	300	300	300	300	165.1 x 3	-	300
165.1	0.197	300	300	300	-	500	500	-	300	-	-	-	-	175	-	-	-	-	6 x 4	300	300
8	0.188	300	300	300	300	450	450	300	300	350	350	400	400	175	300	300	300	300	165.1 x 4	300	300
10	0.188	175	175	-	-	300	450	175	200	NA	NA	350	350	175	175	300	300	300	8 x 6	300	300
12	0.250	175 [*]	175	-	-	300	300	175	300	NA	NA	350	350	175 [*]	175	300	300	300	8 x 165.1	-	300

^{*} 0.330 wall

Unit: psi

Size in	Wall in	7705H	
		UL	FM
8	0.188	450	450

Approved Pressure Ratings by UL & FM

Outlet Coupling and Mechanical Tees

Unit: psi

Model	Sizes (in) (run x branch)	Sch. 40/STD		Sch. 10	
		UL	FM	UL	FM
C-7 Outlet Coupling, Threaded	1 1/2 x 1/2, 3/4 & 1	300	300	300	300
	2 x 1/2, 3/4 & 1	300	300	300	300
	2 1/2 x 1/2, 3/4 & 1	300	300	300	300
	3 x 3/4 & 1	300	300	300	300
	4 x 3/4 & 1	300	300	300	300
	6 x 1 & 1 1/2	300	300	300	300
C-7 Outlet Coupling, Grooved	2 x 1	300	300	300	300
	2 1/2 x 1 1/4 & 1 1/2	300	300	300	300
	3 x 1 & 1 1/2	300	300	300	300
	4 x 1 1/2 & 2	300	300	300	300
M21 Mechanical Tee, Threaded (NPT or BSPT)	6 x 1 1/2 & 2	300	300	300	300
	2 x 1/2, 3/4, 1, 1 1/4 & 1 1/2	300	300	300	300
	2 1/2 x 1/2, 3/4, 1, 1 1/4 & 1 1/2	300	300	300	300
	76.1 x 1/2, 3/4, 1, 1 1/4 & 1 1/2	300	300	300	300
	3 x 1/2, 3/4, 1, 1 1/4, 1 1/2 & 2	300	300	300	300
	4 x 1/2, 3/4, 1, 1 1/4, 1 1/2, 2 & 2 1/2	300	300	300	300
	4 x 76.1	300	300	300	300
	4 x 3	175	175	175	175
	5 x 2 & 2 1/2	300	300	-	300
	5 x 3	300	-	-	-
	139.7 x 2, 76.1 & 3	300	300	300	300
	6 x 1 1/4, 1 1/2, 2 & 2 1/2	300	300	300	300
	6 x 3 & 4	175	175	175	175
	165.1 x 1 1/4, 1 1/2, 2 & 76.1	300	300	300	300
165.1 x 3 & 4	175	175	175	175	
M22 Mechanical Tee, Grooved	2 x 1, 1 1/4 & 1 1/2	300	300	300	300
	2 1/2 x 1, 1 1/4 & 1 1/2	300	300	300	300
	76.1 x 1, 1 1/4 & 1 1/2	300	300	300	300
	3 x 1, 1 1/4, 1 1/2 & 2	300	300	300	300
	4 x 1, 1 1/4, 1 1/2, 2 & 2 1/2	300	300	300	300
	4 x 76.1	300	300	300	300
	5 x 2 & 2 1/2	300	300	300	300
	4 x 3	175	175	175	175
	139.7 x 76.1	300	300	300	300
	6 x 1 1/4, 1 1/2, 2 & 2 1/2	300	300	300	300
	6 x 3 & 4	175	175	175	175
	165.1 x 1 1/4, 1 1/2, 2 & 76.1	300	300	300	300
	165.1 x 3 & 4	175	175	175	175
	4 x 3	300	300	300	300
7721 Threaded (NPT or BSPT)	8 x 2, 2 1/2, 3 & 4	300	300	300	300
	8 x 76.1	300	300	300	300
	4 x 3	300	300	300	300
7722 Grooved	8 x 2, 2 1/2, 3 & 4	300	300	300	300
	8 x 76.1	300	300	300	300
	1 1/4 x 1/2 x 3/4 & 1	300	300	300	300
723 Threaded (NPT or BSPT)	1 1/2 x 1/2 x 3/4 & 1	300	300	300	300
	2 x 1/2 x 3/4 & 1	300	300	300	300
	2 1/2 x 1/2 x 3/4 & 1	300	300	300	300

mm size pipe per EN 10255

Grooved-end Fittings

Unit: psi

Model	Size Range	UL	FM
901 S/R 90 Elbow	2" thru 8"	300	300
903 S/R Tee	2" thru 8"	300	300
	76.1, 165.1	300	-
7110 90 Elbow	1" thru 8"	300	500
	10", 12"	300	300
	14" thru 18"	300	175
	24"	-	175
7111 45 Elbow	1"	-	500
	1 1/4" thru 8"	300	500
	10", 12"	300	300
	14" thru 18"	300	175
	20"	250	250
	24"	250	175
7110DR Drain Elbow	2" thru 6"	300	300
7110LR 1.5D Elbow	2" thru 8"	300	300
7112 22 1/2 Elbow	1 1/4"	-	300
	1 1/2"	500	300
	2" thru 8"	300	300
7113 11 1/4 Elbow	1 1/4" thru 1 1/2"	-	300
	2" thru 8"	300	300
	1 1/4" thru 8"	300	500
7120 Tee	10" thru 14"	300	300
	18"	300	-
	2"x1 1/2" thru 8"x6"	300	300
7121 Reducing Tee	12"x10"	300	-
	2"x2 1/2" thru 4"x6"	300	300
7125 Bullhead Tee	5"x8" thru 6"x8"	300	-
	4"x2 1/2"	300	300
7127 Standpipe Tee	6x2 1/2"	300	-
7130 Lateral	2" thru 8"	300	300
7135 Cross	2" thru 6"	300	300
	8"	300	-
7150 Conc. Reducer	2"x1 1/2" thru 14"x12"	300	300
	16"x8" thru 18"x16"	300	-
7150F Socket Adapter	1 1/2"x1" thru 4"x2 1/2"	300	300
	5"x1 1/2" thru 6"x4"	300	-
7150M Red. Nipple	1 1/2"x1" thru 6"x4"	300	300
7160T Transition Fitting	2"x1" thru 6"x2"	300	300
7151 Ecc. Reducer	2 1/2"x2" thru 8"x6"	300	300
	10"x8" thru 14"x12"	-	300
7160 End Cap	1 1/4" thru 12"	300	300
	10" thru 12"	300	300
	14" thru 18"	300	175
7160H End Cap	20" thru 24"	250	175
	2-1/2" thru 6"	175	175
7170 Flange Adapter	2" thru 8"	300	300
7181 Red. Flange	3"x2" thru 6"x4"	-	300
55 Nipple Adapter	1 1/2" thru 2"	300	300
899 End All	1 1/4"x1/2" thru 2 1/2"x1"	300	300
850 Sprinkler Hub	2"x2"x1" thru 2 1/2"x2 1/2"x1"	300	300
851 Sprinkler Hub	2"x1 1/2"x1" thru 2 1/2"x2x1"	300	300
853 Sprinkler Hub	1 1/2"x1" thru 2 1/2"x1"	300	300

* 20" only for UL

Valves & Components

Unit: psi

Model	Size Range	UL	FM
RCV Riser Check Valve	2 1/2" thru 6"	300	300
726 Y-Straine	2" thru 6"	300	-
	8" thru 12"	175	-
SJ-300F Butterfly Valve	2 1/2" thru 6"	300	300
	8"	300	-

Stainless Steel Series

Sch. 40S and 10S Pipe

Unit: psi

Unit: psi

Size in	Sch. 10S Wall (in)	SS-7		SS-8		SS-41		SS-723		Model	Size Range	UL	FM	
		UL	FM	UL	FM	UL	FM	UL	FM					
1	0.109	300	300	300	300	-	-	1 1/4 x 1/2	300	300	SS-10 90 Elbow	1" thru 8"	300	300
1 1/4	0.109	300	300	300	300	-	-	1 1/4 x 3/4	300	300	SS-11 45 Elbow	1" thru 8"	300	300
1 1/2	0.109	300	300	300	300	-	-	1 1/4 x 1	300	300	SS-20 Tee	1" thru 6"	300	300
2	0.109	300	300	300	300	175	300	1 1/2 x 1/2	300	300	SS-21 Tee	3"x2 1/2" thru 4"x2 1/2"	300	300
2 1/2	0.120	300	300	300	300	175	300	1 1/2 x 3/4	300	300	SS-21F Tee	3"x2", 4"x2"	300	300
3	0.120	300	300	300	300	175	300	1 1/2 x 1	300	300	SS-50 Conc. Reducer	3"x2 1/2" thru 4"x2 1/2"	300	300
4	0.120	300	300	300	300	175	300	2 x 1/2	300	300	SS-50F Conc. Reducer	2 1/2"x2" thru 4"x2"	300	300
5	0.134	300	300	300	300	-	-	2 x 3/4	300	300	SS-60 Cap	1" thru 8"	300	300
6	0.134	300	300	250	300	175	300	2 x 1	300	300	SS-80 Flange Adapter	2" thru 8"	300	300
8	0.148	300	300	-	300	-	-							

Copper Tubing Series

Type K & Type L Copper Tubing

Unit: psi

Unit: psi

Size in	Type K Wall (in)	Type L Wall (in)	C341	
			UL	FM
2	0.083	0.070	200	-
2½	0.095	0.080	200	-
3	0.109	0.090	200	-
4	0.134	0.110	200	-
5	0.160	0.123	200	-
6	0.192	0.140	200	-

FM: Type K only

Model	Size Range	UL	FM
C10 90 Elbow	2" through 4"	175	200
C11 45 Elbow	2" through 4"	175	200
C20 Tee	2" through 6"	175	200
C21 Reducing Tee	2½"x2" thru 6"x5"	200	-
C26 Reducing Tee	2"x¾" thru 4"x½"	200	-
C50 Conc. Reducer	2½"x2" thru 6"x5"	200	-
C52 Conc. Reducer	2"x1" thru 4"x2"	200	-
C60 Cap	2" thru 4"	200	200

Listed Pressure Ratings by IAPMO

The following tables show Shurjoint Couplings used on carbon steel, stainless

steel pipe, and copper tubing; listed by IAPMO in accordance with CSA B242.

Model Z05 Rigid Coupling

Nom. Size	Pipe O.D.	Pressure Ratings	Min. Wall
in	in	PSI	Roll (mm)
mm	mm	Bar	Cut (mm)
1¼	1.660	350	1.7
32	42.2	24	3.6
1½	1.900	350	1.7
40	48.3	24	3.7
2	2.375	350	1.7
50	60.3	24	3.9
2½	2.875	350	2.1
65	73.0	24	4.8
3	3.500	350	2.1
80	88.9	24	4.8
4	4.500	350	2.1
100	114.3	24	5.2
5	5.563	350	2.8
125	141.3	24	5.2
6	6.625	350	2.8
150	168.3	24	5.6
8	8.625	350	2.8
200	219.1	24	6.1

Model Z07 Rigid Coupling

Nom. Size	Pipe O.D.	Pressure Ratings	Min. Wall
in	in	PSI	Roll (mm)
mm	mm	Bar	Cut (mm)
1¼	1.660	500	1.7
32	42.2	35	3.6
1½	1.900	500	1.7
40	48.3	35	3.7
2	2.375	500	1.7
50	60.3	35	3.9
2½	2.875	500	2.1
65	73.0	35	4.8
3	3.500	500	2.1
80	88.9	35	4.8
4	4.500	500	2.1
100	114.3	35	5.2
5	5.563	400	2.8
125	141.3	28	5.2
6	6.625	400	2.8
150	168.3	28	5.6
8	8.625	400	2.8
200	219.1	28	6.1
10	10.750	350	3.4
250	273.0	24	6.4
12	12.750	350	4.0
300	323.9	24	7.1

Model 7705 Flexible Coupling

Nom. Size	Pipe O.D.	Pressure Ratings	Min. Wall
in	in	PSI	Roll (mm)
mm	mm	Bar	Cut (mm)
1¼	1.660	300	1.7
32	42.2	20	3.6
1½	1.900	300	1.7
40	48.3	20	3.7
2	2.375	300	1.7
50	60.3	20	3.9
2½	2.875	300	2.1
65	73.0	20	4.8
3	3.500	300	2.1
80	88.9	20	4.8
4	4.500	300	2.1
100	114.3	20	5.2
5	5.563	300	2.8
125	141.3	20	5.2
6	6.625	300	2.8
150	168.3	20	5.6
8	8.625	300	2.8
200	219.1	20	6.1
10	10.750	175	3.4
250	273.0	12	6.4
12	12.750	175	4.0
300	323.9	12	7.1

Model 7707 Flexible Coupling

Nom. Size	Pipe O.D.	Pressure Ratings	Min. Wall
in	in	PSI	Roll (mm)
mm	mm	Bar	Cut (mm)
1¼	1.660	500	1.7
32	42.2	35	3.6
1½	1.900	500	1.7
40	48.3	35	3.7
2	2.375	450	1.7
50	60.3	31	3.9
2½	2.875	450	2.1
65	73.0	31	4.8
3	3.500	450	2.1
80	88.9	31	4.8
4	4.500	450	2.1
100	114.3	31	5.2
5	5.563	450	2.8
125	141.3	31	5.2
6	6.625	450	2.8
150	168.3	31	5.6
8	8.625	450	2.8
200	219.1	31	6.1
10	10.750	450	3.4
250	273.0	31	6.4
12	12.750	300	4.0
300	323.9	20	7.1

Model 7706 Reducing Coupling

Nom. Size	Pipe O.D.	Pressure Ratings	Min. Wall
in	in	PSI	Roll (mm)
mm	mm	Bar	Cut (mm)
2½x2	2.875x2.375	300	2.1x1.7
65x50	73.0x60.3	20	4.8x3.9
3x2	3.500x2.375	300	2.1x1.7
80x50	88.9x60.3	20	4.8x3.9
3x2½	3.500x2.875	300	2.1x2.1
80x65	88.9x73.0	20	4.8x4.8
4x2½	4.500x2.875	300	2.1x2.1
100x65	114.3x73.0	20	5.2x4.8
4x3	4.500x3.500	300	2.1x2.1
100x80	114.3x88.9	20	5.2x4.8
5x4	5.563x4.500	300	2.8x2.1
125x100	141.3x114.3	20	5.2x5.2
6x4	6.625x4.500	300	2.8x2.1
150x100	168.3x114.3	20	5.6x5.2
8x6	8.625x6.625	300	2.8x2.8
200x150	219.1x168.3	20	6.1x5.6

Model SS-5 Rigid Coupling

Nom. Size	Pipe O.D.	Pressure Ratings	Min. Wall
in	in	PSI	Roll (mm)
mm	mm	Bar	Cut (mm)
1 ¼	1.660	300	1.7
32	42.2	20	3.6
1 ½	1.900	300	1.7
40	48.3	20	3.7
2	2.375	300	1.7
50	60.3	20	3.9
2 ½	2.875	300	2.1
65	73.0	20	4.8
3	3.500	300	2.1
80	88.9	20	4.8
4	4.500	300	2.1
100	114.3	20	5.2
5	5.563	300	2.8
125	141.3	20	5.2
6	6.625	300	2.8
150	168.3	20	5.6
8	8.625	300	2.8
200	219.1	20	6.1

Model SS-7 Rigid Coupling

Nom. Size	Pipe O.D.	Pressure Ratings	Min. Wall
in	in	PSI	Roll (mm)
mm	mm	Bar	Cut (mm)
1 ¼	1.660	300	1.7
32	42.2	20	3.6
1 ½	1.900	300	1.7
40	48.3	20	3.7
2	2.375	300	1.7
50	60.3	20	3.9
2 ½	2.875	300	2.1
65	73.0	20	4.8
3	3.500	300	2.1
80	88.9	20	4.8
4	4.500	300	2.1
100	114.3	20	5.2
5	5.563	300	2.8
125	141.3	20	5.2
6	6.625	300	2.8
150	168.3	20	5.6
8	8.625	300	2.8
200	219.1	20	6.1

Model C305 Rigid Coupling

Nom. Size	Pipe O.D.	Pressure Ratings	Min. Wall
in	in	PSI	Roll (mm)
mm	mm	Bar	
2	2.125	300	1.1
50	54.0	20	
2 ½	2.625	300	1.1
65	66.7	20	
3	3.125	300	1.1
80	79.4	20	
4	4.125	300	1.5
100	104.8	20	
5	5.125	300	1.8
125	130.2	20	
6	6.125	300	2.1
150	155.6	20	

Model C306 Reducing Coupling

Nom. Size	Pipe O.D.	Pressure Ratings	Min. Wall
in	in	PSI	Roll (mmxmm)
mm	mm	Bar	
2 ½x2	2.625x2.215	300	1.1x1.1
65x50	66.7x54.0	20	
3x2	3.125x2.125	300	1.1x1.1
80x50	79.4x54.0	20	
3x2 ½	3.125x2.625	300	1.1x1.1
80x65	79.4x66.7	20	
4x2 ½	4.125x2.625	300	1.5x1.1
100x65	104.8x66.7	20	
4x3	4.125x3.125	300	1.5x1.1
100x80	104.8x79.4	20	
5x4	5.125x4.125	200	1.8x1.5
125x100	130.2x104.8	14	
6x4	6.125x4.125	200	2.1x1.5
150x100	155.6x104.8	14	

Model C307 Transition Coupling

Nom. Size	Pipe O.D.	Pressure Ratings	Min. Wall
in	in	PSI	Roll (mm)
mm	mm	Bar	
2	2.375x2.125	300	1.1
50	60.3x54.0	20	
2 ½	2.875x2.625	300	1.1
65	73.0x66.7	20	
3	3.500x3.125	300	1.1
80	88.9x79.4	20	
4	4.500x4.125	300	1.5
100	114.3x104.8	20	

Note:

Minimum wall thickness listed corresponds to Table 1 of ASME B36.10M Roll/Cut groove for carbon steel & stainless steel pipe end or Table 1 of ASTM B306 for copper tubing.

Typical Applications - Flexible Couplings – Sprinkler Systems (NFPA 13)

The following illustrations are part of NFPA 13 – 2013 Annex A Explanatory Material. These are for informational purposes only and

not a mandatory requirement. For specific requirements for any other areas of sprinkler systems, refer to the latest version of NFPA 13.

1. Flexible couplings for main risers and branch line riser

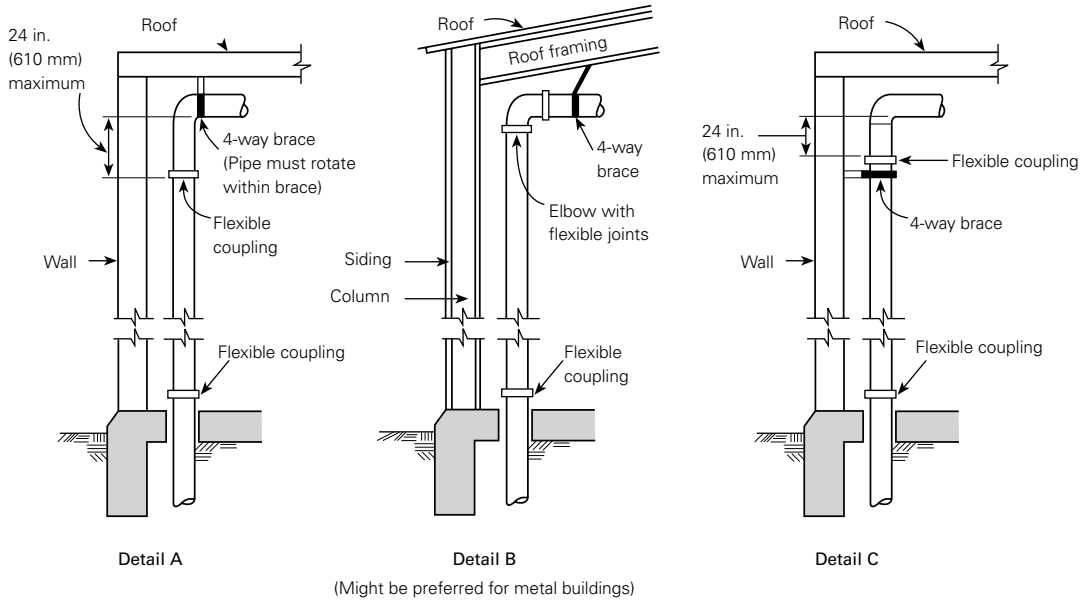

Note to Detail A: The four-way brace should be attached above the upper flexible coupling required for the riser and preferably to the roof structure if suitable. The brace should not be attached directly to a plywood or metal deck.

FIGURE A.9.3.2(a) Riser Details.

2. Flexible couplings on horizontal portion of Tie-In

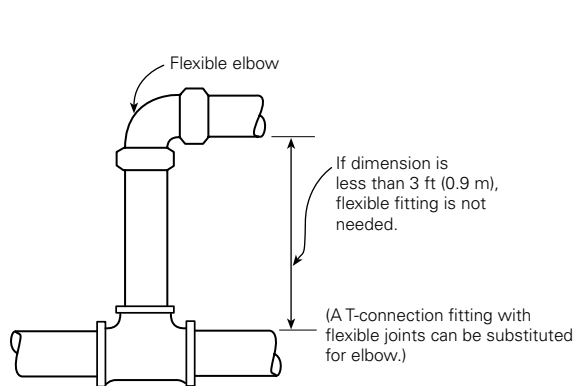

FIGURE A.9.3.2(b) Detail at Short Riser.

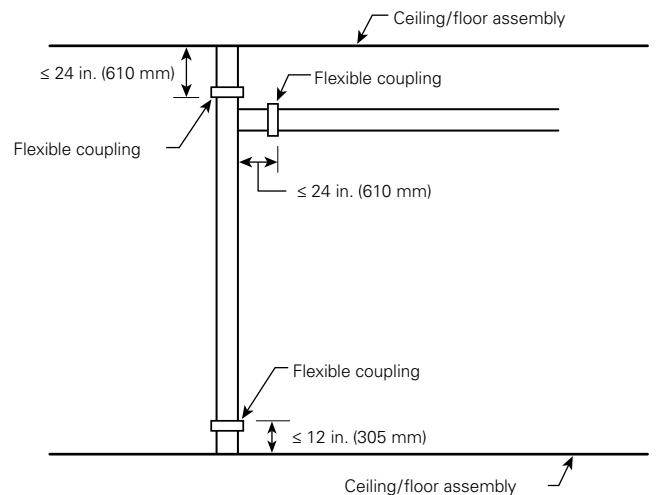

FIGURE A.9.3.2(2) Flexible Coupling on Horizontal Portion of Tie-In.

3. Flexible Coupling on Main Riser and Branch Line Riser

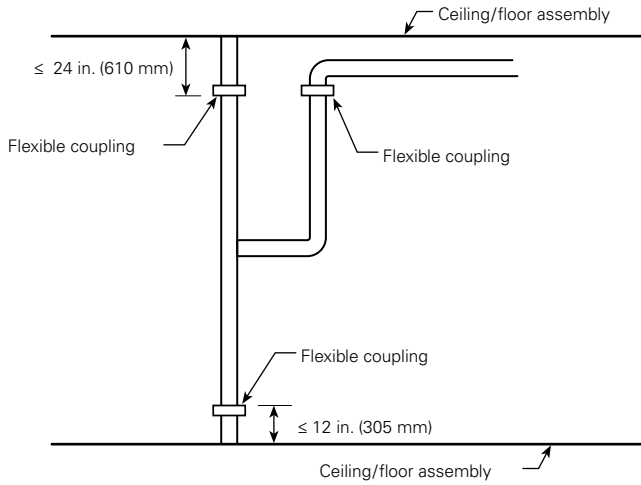

FIGURE A.9.3.2.3(2)(b) Flexible Coupling on Main Riser and Branch Line Riser.

4. Flexible couplings for drops

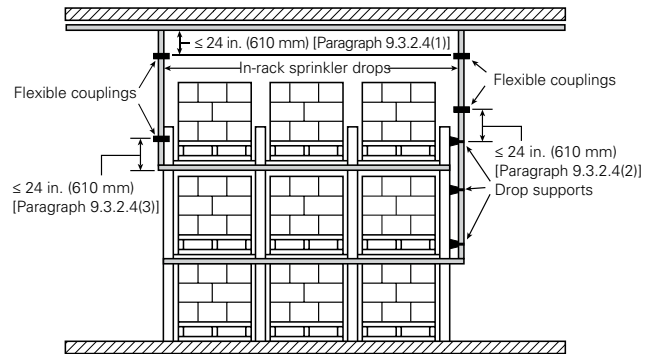
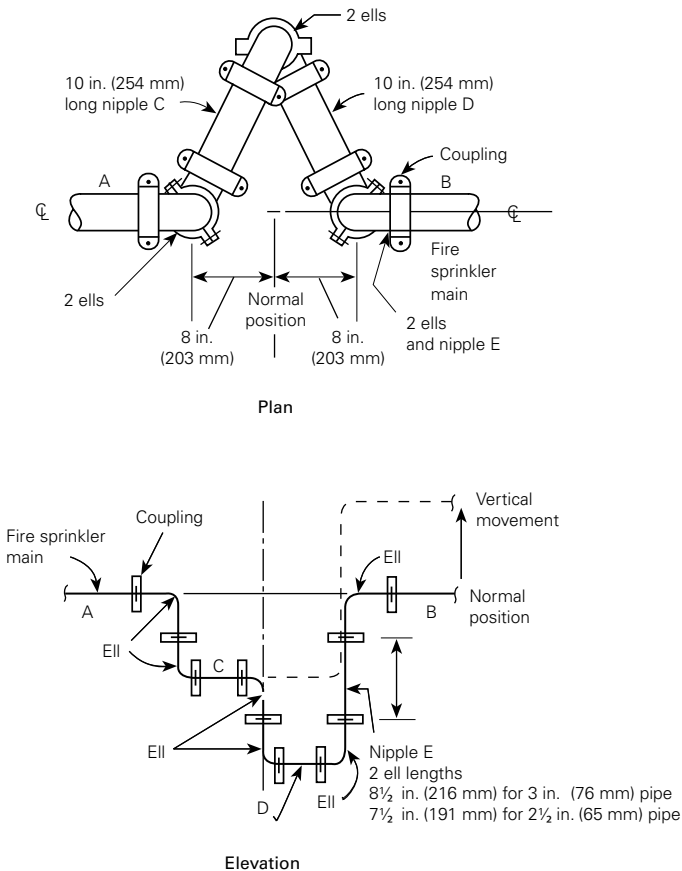
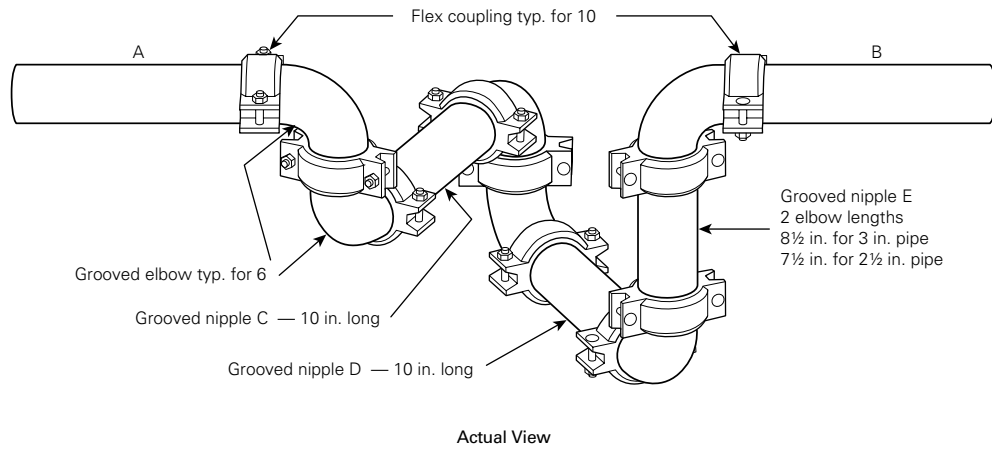

FIGURE A.9.3.2.4 Flexible Couplings for Drops.

5. Seismic Separation Assembly





6. Earthquake protection for sprinkler piping

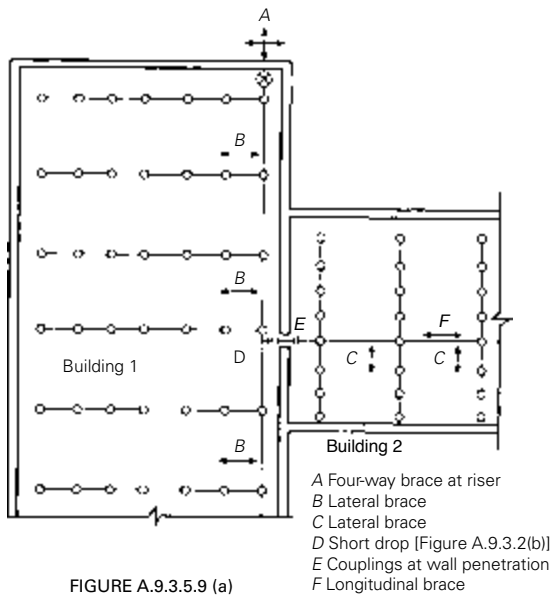

7. Typical Location of Bracing on a Looped System

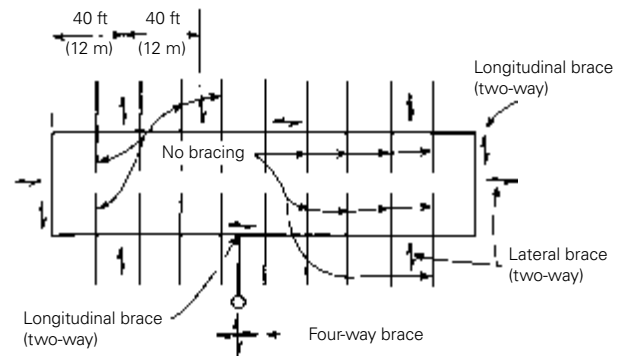

FIGURE A.9.3.5.6 (d)
Typical Location of Bracing on a Looped System.

Systems having more flexible couplings than required above shall be provided with additional sway bracing. A lateral brace shall be provided within 24" (600 mm) of every other coupling unless pipes are supported by rods less than 6" (152 mm) long from the ceiling or by U-type hooks underside of the structural element. (NFPA 13 – 2013 9.3.2. & 9.3.5.)

Index

Model No.	Page No.	Model No.	Page No.	Model No.	Page No.	Model No.	Page No.
49	33	7151	61	C306	166	RX-3770	145
55	68	7160	62	C307	167	S35	150
56	68	7170	36	C341	167	SD-28A	150
57	69	7180	37	C50	169	SJ-200	107
58	69	7181	37	C52	170	SJ-300F	110
59	69	7705	23	C55	170	SJ-300N	108
71	133	7706	27	C55T	171	SJ-400	99
79	151	7707	24	C60	168	SJ-530	112
96	166	7721	39	C-7	29	SJ-500L	111
651	116	7722	43	C723	172	SJ-500W	112
723	47	7771	21	C726	173	SJ-630	100
726	119	10EP	79	DE30-GG	171	SJ-600L	98
728	120	11EP	79	G28	28	SJ-600W	98
811	127	20EP	79	H305	157	SJ-900	113
812	127	22EP	79	H307	158	SJ-915	114
813	127	35EP	79	H312	159	SJ-930	115
814	127	7110-B	64	K-9	18	SJ-C300	174
815	128	7110DR	65	L11-3D	76	SS-10	92
815	128	7110LR	63	L11-5D	77	SS-11	92
816	129	7111LR	63	L11-6D	78	SS-1200	90
817	129	7112G	64	L22-3D	76	SS-20	92
818	129	7150F	67	L22-5D	77	SS-21	93
819	130	7150M	67	L22-6D	78	SS-28	91
820	130	7160H	63	L30-3D	76	SS-21F	94
825	130	7160P	62	L30-5D	77	SS-41	95
827	130	7160T	62	L30-6D	78	SS-5	85
830	131	725G	117	L45-3D	76	SS-50	93
831	130	725F	118	L45-5D	77	SS-50F	94
832	130	72C	134	L45-6D	78	SS-60	92
841	131	72R	134	L60-3D	76	SS-7	86
850	70	7706-T	30	L60-5D	77	SS-723	96
851	70	7707L	26	L60-6D	78	SS-726	97
853	70	7707N	25	L90-3D	76	SS-7X	87
899	68	7771-T	30	L90-5D	77	SS-8	88
901	65	A10	181	L90-6D	78	SS-80	95
903	65	A10R	182	M07	16	SS-8X	89
7041	33	A11	181	M21	41	W110LR	72
7043	35	A20	181	M22	45	W111LR	72
7110	57	A25	182	R-88	139	W120	72
7111	57	A50	182	R-88	140	W121	73
7112	57	A505	179	R-88	142	W135	75
7113	57	A507	180	R-88N	141	W137	75
7114	71	A512	180	RCV	121	W150	74
7120	58	A60	181	RH-1000	144	W151	74
7121	59	B20	132	RJ-10	146	W160	72
7122	71	B24	132	RJ-11	146	XH-1000	22
7125	66	BH-22C	121	RJ-20	146	XH-70EP	31
7127	65	C10	168	RJ-21	147	Z05	17
7130	58	C11	168	RJ-50	147	Z07	19
7133	71	C20	168	RJ-51	147	Z07N	20
7135	58	C21	169	RJ-60	146		
7137	63	C26	169	RJ-70	147		
7150	61	C305	165	RX-3000	144		

Your local distributor is:



Shurjoint specifications and or designs are subject to change without notice and or obligation

© Copyright 2020 Shurjoint SJ-CAT-2020-EN-Rev.1